

---

---

**Observed Fires**

---

---

**SEPTEMBER 2017**

**DISTRIBUTION RESTRICTION:** Approved for public release; distribution is unlimited.

This publication supersedes ATP 3-09.30, Observed Fires dated 12 August 2013.

---

---

**Headquarters Department of the Army**

---

---

This publication is available at the Army Publishing  
Directorate site (<http://www.apd.army.mil>),  
and the Central Army Registry site  
(<https://atiam.train.army.mil/catalog/dashboard>)

# Observed Fires

## Contents

	Page
<b>PREFACE</b> .....	<b>vii</b>
<b>INTRODUCTION</b> .....	<b>ix</b>
<b>Chapter 1 INTRODUCTION TO FIRE SUPPORT</b> .....	<b>1-1</b>
Fire Support Effectiveness .....	1-1
Fire Support Planning and Coordination .....	1-6
Targets.....	1-7
<b>Chapter 2 EMPLOYING FIRE SUPPORT</b> .....	<b>2-1</b>
Fire Support Team.....	2-1
Observation Post.....	2-12
<b>Chapter 3 TARGET LOCATION AND IDENTIFICATION</b> .....	<b>3-1</b>
Introduction to Target Location.....	3-1
Direction.....	3-3
Distance.....	3-8
Altitude.....	3-13
Terrain Sketch .....	3-14
Methods of Target Location.....	3-15
Target Location ERROR.....	3-19
Combat Identification of a Target .....	3-23
Positive Identification of a Target .....	3-24
<b>Chapter 4 CALL FOR FIRE</b> .....	<b>4-1</b>
Description.....	4-1
Six Elements Of The Call For Fire.....	4-2
Correction of Errors .....	4-9
Message to Observer .....	4-10
Additional Information .....	4-11
Authentication.....	4-16
FDC Commands.....	4-17
Sample Missions .....	4-17
<b>Chapter 5 ADJUSTMENT OF FIRE</b> .....	<b>5-1</b>
Adjusting Point.....	5-1
Spotting.....	5-1
Types of Corrections .....	5-5
Sequence of Subsequent Corrections.....	5-7
Adjustment Techniques .....	5-10
Fire for Effect .....	5-13

**Distribution Restriction:** Approved for public release; distribution is unlimited.

\*This publication supersedes ATP 3-09.30, Observed Fires dated 12 August 2013.

	Refinement and Surveillance .....	5-13
	Types of Corrections .....	5-14
	Registration .....	5-14
	Destruction Mission .....	5-36
	High-Burst or Mean Point of Impact Registration .....	5-36
	Target of Opportunity .....	5-41
	Planned Target.....	5-41
	Moving Target Calculation .....	5-41
	Trigger and Intercept Point Considerations .....	5-45
	Helpful Notes.....	5-46
<b>Chapter 6</b>	<b>SPECIAL MUNITIONS .....</b>	<b>6-1</b>
	Characteristics of the Excaliber .....	6-1
	Ballistic Impact Point.....	6-2
	Sample Excalibur Mission .....	6-2
	Characteristics of the Accelerated Precision Mortar Initiative (APMI) .....	6-3
	Characteristics of the Precision Guidance Kit.....	6-4
	Characteristics of the Guided MLRS.....	6-4
	Sample GLMRS Mission .....	6-5
	Characteristics of Improved Conventional Munitions.....	6-5
	ICM Call for Fire and Adjustment.....	6-7
	Sample ICM Missions .....	6-7
	ICM Considerations.....	6-8
	Characteristics of Field Artillery Scatterable Mines .....	6-9
	Types of Minefields .....	6-10
	Selection of Minefield Density.....	6-10
	Selection of SD Time .....	6-11
	Target Location .....	6-11
	Call for Fire and Adjustment .....	6-12
	Sample Scatmine Missions.....	6-13
	Characteristics of Illumination .....	6-13
	Employment Considerations .....	6-14
	Call for and Adjustment of Illumination .....	6-16
	Coordinated and continuous Illumination.....	6-17
	Infrared Illumination.....	6-20
	Characteristics of Smoke .....	6-20
	Smoke Rounds.....	6-21
	Employment Considerations.....	6-22
	Smoke Delivery Techniques .....	6-27
	Immediate Smoke .....	6-28
	Quick Smoke.....	6-29
	Example Missions .....	6-30
	Mortar Procedures .....	6-31
<b>Chapter 7</b>	<b>OBSERVER SPECIAL MISSIONS.....</b>	<b>7-1</b>
	Fires for Pilots .....	7-1
	High-Angle Fire .....	7-3
	Final Protective Fire .....	7-4
	Multiple Missions.....	7-7
	Auxiliary Adjusting Point .....	7-7
	Observer Not Oriented.....	7-7
	Irregularly Shaped Target .....	7-8
	Adjustment by Sound.....	7-9
<b>Appendix A</b>	<b>OBSERVER SELF-LOCATION METHODS .....</b>	<b>A-1</b>
<b>Appendix B</b>	<b>CRATER AND SHELL FRAGMENT ANALYSIS AND REPORTS .....</b>	<b>B-1</b>

**GLOSSARY** ..... **Glossary-1**

**REFERENCES** ..... **References-1**

Related Publications ..... 1

**PRESCRIBED FORMS** ..... 2

Related Forms ..... 3

**INDEX** ..... **Index-1**

## Figures

Figure 1-1. Effectiveness compared to length of adjustment ..... 1-4

Figure 1-2. Number of rounds required for equivalent effect. .... 1-4

Figure 1-3. Ammunition expenditures and relative effects ..... 1-5

Figure 1-4. Sample DA Form 4655, target list worksheet ..... 1-9

Figure 1-5. Point target..... 1-9

Figure 1-6. Linear target..... 1-10

Figure 1-7. Rectangular target ..... 1-10

Figure 1-8. Circular target ..... 1-10

Figure 1-9. Final protective fire..... 1-11

Figure 1-10. Target reference point ..... 1-11

Figure 1-11. Group of targets ..... 1-12

Figure 1-12. Series of Targets..... 1-12

Figure 2-1 JFO-JTAC Employment Example ..... 2-10

Figure 3-1. Example of mil relation formula in shift from known point ..... 3-4

Figure 3-2. Cardinal directions ..... 3-4

Figure 3-3. Angle T..... 3-6

Figure 3-4. M22 and M24 binocular reticle pattern ..... 3-6

Figure 3-5. Example hand measurement of angular deviation ..... 3-7

Figure 3-6. Observed fire fan (1:50,000) (graphic training aid 6-7-3) ..... 3-11

Figure 3-7. Target location using the OF fan ..... 3-12

Figure 3-8. Vertical shift ..... 3-13

Figure 3-9. Vertical angle ..... 3-14

Figure 3-10. Example terrain sketch ..... 3-15

Figure 3-11. Polar plot..... 3-17

Figure 3-12. Lateral shift ..... 3-18

Figure 3-13. Range shift..... 3-19

Figure 3-14. TLE Categories ..... 3-20

Figure 4-1. Shift from a known point ..... 4-4

Figure 4-2 (Call For Fire flowchart) ..... 4-9

Figure 4-3 JFO Target Brief (JP 3-09.3) ..... 4-13

Figure 4-4 CAS 9 line (ATP 3-09.32) ..... 4-14

Figure 4-5 Rotary Wing 5-Line Request (JP 3-09.3)..... 4-15

Figure 4-6 Naval Surface Fire Support Request (ATP 3-09.32) ..... 4-16

## Contents

---

Figure 5-1. Adjusting point in an area fire mission .....	5-1
Figure 5-2. Range spotting .....	5-3
Figure 5-3. Deviation spottings .....	5-4
Figure 5-4. Height of burst corrections .....	5-7
Figure 5-5. Successive bracketing technique .....	5-11
Figure 5-6. Hasty bracketing technique .....	5-12
Figure 5-7. No range refinement necessary .....	5-16
Figure 5-8. Drop 10.....	5-17
Figure 5-9. Drop 20.....	5-17
Figure 5-10. Example registration diagram, page 1 .....	5-18
Figure 5-11. Example registration diagram, page 2 .....	5-19
Figure 5-12. Mortar registration .....	5-21
Figure 5-13. Adjusting mortar sheaf .....	5-22
Figure 5-14. Section right, repeat .....	5-23
Figure 5-15. Number three is adjusted .....	5-24
Figure 5-16. Quick and time registration example, page 1.....	5-26
Figure 5-17. Quick and time registration example, page 2.....	5-27
Figure 5-18. Quick and time registration-range correct spotting example, page 1.....	5-28
Figure 5-19. Quick and time registration-range correct spotting example, page 2.....	5-30
Figure 5-20. Quick and time registration during adjustment example, page 1 .....	5-31
Figure 5-21. Quick and time registration during adjustment example, page 2 .....	5-32
Figure 5-22. Abbreviated registration example, page 1.....	5-34
Figure 5-23. Abbreviated registration example, page 2.....	5-35
Figure 5-24. Destruction mission .....	5-36
Figure 5-24. Reorientation after the first round.....	5-39
Figure 5-25. Determining the intercept point .....	5-43
Figure 5-26. Determining the trigger point.....	5-44
Figure 6-1. APICM grenades .....	6-6
Figure 6-2. 155-mm DPICM grenade .....	6-6
Figure 6-3. RAAMS mine.....	6-9
Figure 6-4. ADAM mine .....	6-10
Figure 6-5. Aimpoint location for moving targets .....	6-12
Figure 6-6. Aimpoint location for stationary targets .....	6-12
Figure 6-7. Illumination range spread .....	6-15
Figure 6-8. Illumination lateral spread .....	6-16
Figure 6-9. Illumination range and lateral spread.....	6-16
Figure 6-10. Initial illuminating round.....	6-19
Figure 6-11. Obscuring smoke .....	6-20
Figure 6-12. Screening smoke.....	6-21
Figure 6-13. Optimum wind speed chart.....	6-24
Figure 6-14. Classification of wind directions .....	6-25

Figure 6-15. Maneuver-target line .....	6-26
Figure 7-1. Observer- target line, gun-target line and cardinal direction.....	7-2
Figure 7-2. Aircraft target location .....	7-3
Figure 7-3. High angle fire.....	7-4
Figure 7-4. Adjustment of the FPF begins with the flank piece round closest to the FPF line (number 1) .....	7-5
Figure 7-5. Adjustment of the FPF begins with the flank piece round closest to the FPF line (number 6) .....	7-6
Figure 7-6. Auxiliary adjusting point .....	7-7
Figure 7-7. Target attitude.....	7-8
Figure A-1. Self-location by use of two known points .....	A-2
Figure A-2. Self-location by use of one known point and one burst.....	A-3
Figure A-3. Self-location by use of two bursts.....	A-4
Figure A-4. Location second observation post by simultaneous observation .....	A-6
Figure B-1. Curvature template .....	B-2
Figure B-2. Fuze furrow and center-of-crater method.....	B-3
Figure B-3. Side-spay method.....	B-4
Figure B-4. Ricochet furrow method.....	B-5
Figure B-5. Main axis method .....	B-6
Figure B-6. Splinter groove method .....	B-7
Figure B-7. Fuze tunnel method.....	B-7
Figure B-8. Projectile .....	B-8
Figure B-9. Shell fragment and tail identification, US ammunition .....	B-9
Figure B-10. Other nation's ammunition .....	B-10
Figure B-11. Other nation's ammunition (continued) .....	B-11
Figure B-12 DA Form 2185 (Artillery Counterfire Information).....	B-12

## Tables

Table 1-1. FPF planning.....	1-8
Table 1-2. Assignment of blocks of numbers (example).....	1-14
Table 1-3. Allocation of blocks of numbers (example) .....	1-14
Table 2-1. Fire Support Team Headquarters .....	2-1
Table 2-2. FO Team .....	2-2
Table 3-1. Considerations in mental estimation of distance .....	3-9
Table 3-2. Estimation by appearance of trees .....	3-9
Table 3-3. Equipment dimensions.....	3-10
Table 3-4. Targeting Device Methodology for Artillery and Mortars.....	3-20
Table 4-1. Fire mission (grid) initial fire request .....	4-18
Table 4-2. Fire mission (shift) initial fire request .....	4-18
Table 4-3. Fire mission (polar) initial fire request .....	4-19

## Contents

---

Table 4-4. Fire mission (suppression) .....	4-19
Table 4-5. Fire mission (immediate suppression) .....	4-19
Table 5-1. Determination of deviation corrections .....	5-6
Table 5-2. Refinement and surveillance .....	5-14
Table 5-3. Registration on a known point .....	5-15
Table 5-4. Registration on a point selected by observer .....	5-15
Table 5-5. Registration with two lots .....	5-33
Table 5-6. Helpful notes for the observer .....	5-46
Table 6-1. Characteristics of Excalibur .....	6-1
Table 6-2. Fire for effect Excalibur with proximity fuze .....	6-3
Table 6-3. Fire for effect Excalibur with delay fuze .....	6-3
Table 6-4. Fire for effect with APMI .....	6-4
Table 6-5. Fire for effect with GLMRS unitary .....	6-5
Table 6-6. Improved conventional munitions .....	6-5
Table 6-7. Fire for effect with ICM .....	6-7
Table 6-8. HE adjustment, APICM in effect .....	6-8
Table 6-9. ICM adjustment, ICM in effect .....	6-8
Table 6-10. Minefield density for RAAMS and ADAM .....	6-11
Table 6-11. Fire for effect mission with ADAM .....	6-13
Table 6-12. AF mission with RAAMS .....	6-13
Table 6-13. Employment factors for illuminating shells .....	6-14
Table 6-14. Smoke planning data (ATP 3-09.42) .....	6-22
Table 6-15. Temperature gradient effects on smoke .....	6-23
Table 6-16. HC and WP smoke effectiveness based on relative humidity .....	6-24
Table 6-17. Equivalent wind scale for estimating wind speed .....	6-25
Table 6-18. Conditions for smoke employment .....	6-26
Table 6-19. Smoke delivery techniques .....	6-28
Table 7-1. Fire Support information for pilots .....	7-1



## Preface

Army Techniques Publication (ATP) 3-09.30 sets forth the doctrine pertaining to the organization, equipment, mission command, operations, and provides techniques for employing fire support assets as an observer which can be applied within the framework of decisive action or unified land operations. It is applicable to any Army personnel observing for artillery or mortar fires, close air support, army attack aviation, or naval surface fire support. See ATP 3-09.32 for information on close air support, army attack aviation, or naval surface fire support.

The principal audience for this publication is FA commanders, staffs, and personnel at the field artillery brigade (FAB), division artillery (DIVARTY), and brigade combat team (BCT) and separate FA battalions and below.

Commanders, staffs, and subordinates ensure that their decisions and actions comply with applicable United States, international, and in some cases host-nation laws and regulations. Commanders at all levels ensure that their Soldiers operate in accordance with the law of war and the rules of engagement (See FM 27-10).

This publication is the principle reference for observed fire.

ATP 3-09.30 uses joint terms where applicable. Selected joint and Army terms and definitions appear in both the glossary and the text. Terms for which Publication ATP 3-09.30 is the proponent publication (the authority) are marked with an asterisk (\*) in the glossary. Definitions for which Publication ATP 3-09.30 is the proponent publication are boldfaced in the text with the term being italicized. For other definitions shown in the text, the term is italicized and the number of the proponent publication follows the definition.

ATP 3-09.30 applies to the Active Army, Army National Guard of the United States, and United States Army Reserve unless otherwise stated.

The proponent of Publication ATP 3-09.30 is the United States Army Training and Doctrine Command. The U.S. Army Field Artillery School is the preparing agency. Send comments and recommendations on DA Form 2028, Recommended Changes to Publications and Blank Forms, to Directorate of Training and Doctrine, 700 McNair Avenue, Suite 128, ATTN: ATSF-DD, Fort Sill, OK 73503-4436; by email to: [usarmy.sill.fcoe.mbx.dotd-doctrine-inbox@mail.mil](mailto:usarmy.sill.fcoe.mbx.dotd-doctrine-inbox@mail.mil).

This page intentionally left blank.

# Introduction

Army forces are employed with other Services as part of a joint force. Consequently, this ATP is grounded in joint doctrine as found in joint publications JP 3-09, JP 3-09.3, and JP 3-60. ATP 3-09.30 ties prescriptive Army doctrine publications such as Army doctrine publication (ADP) and Army doctrine reference publication (ADRP) 3-09 to field artillery operations techniques in support of the maneuver commander. To comprehend the doctrine contained in this publication, readers must first understand the overarching guidance provided to all members of the Army Profession in ADP 1 and ADP 3-0 and their references publications ADRP 1 and ADRP 3-0. Readers must also understand the principles of the joint operations (JP 3-0), joint fire support (JP 3-09), and joint targeting (JP 3-60). Whereas ADP 1 describes the missions, purpose, roles, and core competencies of the Army, ADRP 1 prescribes the moral principles for how and why the Army shapes, fights, and wins our Nation's wars – in the right way – setting the tone for all our operations to maintain trust within and external to our profession. ADRP 3-0 provides a common understanding for accomplishing Army missions in unified land operations under ADRP 6-0 Mission Command.

*Techniques* are non-prescriptive ways or methods used to perform missions, functions, or tasks (CJCSM 5120.01A). The techniques herein build on the collective knowledge and experience gained through recent operations, numerous exercises, and the deliberate process of informed reasoning. These techniques are rooted in the fires principles identified in ADP 3-09, ADRP 3-09, FM 3-09, and accommodate force design changes, new technologies and diverse adversaries.

ATP 3-09.30 is organized into 7 chapters and 2 appendices. The Crater and Shell Fragment Analysis Reports Annex (B) was re-introduced to this ATP. Joint Fires Observer (JFO) responsibilities and duties, Close Air Support (CAS), Army Attack Aviation, Naval Surface Fire Support (NSFS), and “Target Talk On” procedures were added to this ATP.

Chapter 1 is an introduction to fire support and the relationship between maneuver and the observer for the effective accomplishment of tasks during operations.

Chapter 2 describes the responsibilities of members of the fire support team (FIST), forward observer (FO) team, and options for employing observers and guidance for selecting and occupying an observation post.

Chapter 3 describes the requirements for target location and identification by an observer in terms the shooter can understand.

Chapter 4 describes the requirements for the call for fire and the goal to send the required information to the appropriate unit rapidly, accurately, and in sufficient detail to enable the firing unit to engage the target properly.

Chapter 5 details the procedures for adjusting fire.

Chapter 6 discusses the characteristics and any special considerations or techniques required to fire special munitions.

Chapter 7 provides guidance on missions requiring special procedures for the observer.

Appendix A describes the techniques the observer can use to self-locate in both a global positioning, and a degraded, denied, disrupted space operations environment.

Appendix B describes the process of conducting and reporting for crater analysis and shelling reports.

Based on current doctrinal changes, certain terms have been added, modified, or rescinded for purposes of this manual. The glossary contains acronyms and defined terms.

This publication identifies suggested duties and responsibilities of key personnel and addresses techniques for employing fire support and touches on fire support planning considerations. It is based on current tables of organization and equipment and provides a starting point from which commanders can adjust their operations and training based on local training scenarios and the six factors of mission variables; mission, enemy, terrain and weather, troops and support available, time available, and civil considerations (METT-TC).

---

*Note:* METT-TC is memory aid that identifies mission variables. Army leaders use mission variables to synthesize operational variables and tactical level information with local knowledge about conditions relevant to their mission. For more information on operational and mission variables, see ADP 3-0. Mission variables will be used throughout the remainder of this document.

---

## Chapter 1

# Introduction to Fire Support

Fire support is fires that directly support land, maritime, amphibious, and special operations forces to engage enemy forces, combat formations, and facilities in pursuit of tactical and operational objectives (Joint Publication [JP] 3-09). It requires close coordination and integration with maneuver forces. Effective fire support requires an observer that understands the tasks to accomplish and how these tasks support the overall operation. The observer must be able to accurately locate targets, understand which targets to attack, and effectively communicate what is seen to the rest of the fire support community.

### **FIRE SUPPORT EFFECTIVENESS**

1-1. Fire support gunnery involves the coordinated efforts of the observer, fires cell, fire direction center (FDC), and firing elements each linked by an adequate communications and computer system. Team members must operate with a sense of urgency, continually strive to reduce the time required to execute an effective fire mission, and strive to achieve first round fire for effect. To achieve accurate first-round fire for effect on a target, an artillery unit must compensate for nonstandard conditions as completely as time and the tactical situation permit. There are five requirements for achieving accurate first-round fire for effect. These five requirements for accurate fires are: accurate target location and size, accurate firing unit location, accurate weapon and ammunition information, accurate meteorological information, and accurate computational procedures. The observer is solely responsible for the first requirement. Failure to provide accurate target location and size may require adjust fire missions resulting in increased ammunition expenditure, decreased effects on target, and an increased risk of detection by hostile Target Acquisition (TA) assets. (See FM 3-09 for greater discussion of the five requirements for accurate fires.) “Additionally, trusted Army professionals are expected to make right decisions (i.e., ethical, effective, and efficient) and take actions consistent with the moral principles of the Army Ethic. Fire support execution is enhanced through the proper applications of planning, coordination, synchronization, and execution of lethal joint fires and nonlethal actions in order to create desired effects. Finally, targeting of fires in decisive actions requires the judicious use of lethal force balanced with restraint, tempered by professional judgment.”

### **OBSERVER**

1-2. The observer serves as the "eyes" of indirect fire systems, detects and locates suitable targets within the area of observation. To ensure that the first requirement of accurate fires is met, the observer must use the most accurate method of target location available. To attack a target the observer transmits a call for fire and when necessary, adjusts the fires onto the target. An observer provides surveillance data pertaining to fires.

### **FIRES CELL**

1-3. The fires cell and its elements integrate the fires warfighting function into operations. It has resources to plan for future operations from the main command post and to support current operations from the tactical command post (when deployed). Additionally the cell has the limited capability to provide coverage to the command group and the deputy command group when deployed. The fires cell is the centerpiece of the targeting process, focused on integrating both lethal and nonlethal effects. The fires cell thus collaboratively plans, coordinates and synchronizes fire support, to include joint fires.

## **FIRE DIRECTION CENTER**

1-4. An FDC serves as the "brain" of the system. It receives the call for fire from the observer and sends a fire order to the firing unit. An FDC has the capability to determine how to attack a target (tactical fire direction) as well as determining firing data and converting this data into fire commands (technical fire direction).

## **ARTILLERY FIRING UNIT**

1-5. The firing platoon is the basic firing element of the cannon or rocket battalion. The platoon has command system capabilities to interface with the battalion command posts, battery operation centers, and fire direction centers. In special circumstances, the platoon may be further divided into smaller firing units such as pairs or individual howitzers or launchers.

## **MORTARS**

1-6. Mortars provide unique indirect fires that are responsive to the ground maneuver commander. Their rapid, high-angle fires are invaluable against dug in adversaries and targets in defilade, which are not vulnerable to attack by direct fires. Although they are part of the total fire support system, mortar sections and platoons are not simply small artillery batteries. Mortars allow the maneuver commander to quickly place indirect fires on the adversary. All mortar sections and platoons exist to provide immediate responsive fires to meet the rapid changes in the tactical situation on the battlefield.

## **ROCKETS AND MISSILES**

1-7. The Army Tactical Missile System (ATACMS), Guided Multiple Launch Rocket System (GMLRS) provides long range, surface to surface fires against, well defended high-payoff targets, day or night, and in nearly all weather conditions. ATACMS can support a range of operations including suppression of enemy Air Defense (SEAD), counterfires, and strikes requiring high levels of accuracy. Their reliability, accuracy, and range make them viable against stationary, non-hardened targets. However, due to their extremely high altitude of delivery (apex of missile trajectory), close coordination must be made with air planners and liaisons to ensure that aircraft are not in the vicinity during missiles' terminal falls. The missiles fired from a multiple launch rocket system (MLRS) and a high mobility artillery rocket system (HIMARS) launcher deliver warheads that include antipersonnel and antimateriel bomblets, unitary high-explosive charges, or guided submunitions. MLRS and HIMARS provide the joint force with counterfire and capacity to strike enemy defenses, light materiel, and personnel targets. These weapon systems supplement cannon artillery fires with large volumes of fires against selected targets. The MLRS and HIMARS typically fire free-flight rockets against area targets and guided munitions against point targets.

## **NAVAL SURFACE FIRE SUPPORT**

1-8. Naval Surface Fire Support (NSFS) provides fire support by naval surface gun, missile, and EW systems in support of a unit or units tasked with achieving the commander's objectives. Naval assets can provide support in a unique manner and should be considered as one source of fire support along with other components and weapon systems. When the number of ships permits, individual ships will be assigned as Direct Support (DS) to assault battalions. The DS mission establishes the priority in which the ship will process calls for supporting fire and the anticipated zone of fire (ZF). The ship delivers fires on planned targets and targets of opportunity in the ZF, which normally corresponds to the zone of action of the supported unit. When possible, ships capable of performing simultaneous missions will be given a DS mission, to allow for maximum fire support to the forward units of the landing force. JP 3-09

## **AIR TO SURFACE**

1-9. Aviation delivered fires are more complex than surface to surface fires due to the greater variety of weapons effects and delivery conditions. **Fixed Wing Aircraft** provide the commander's flexibility, range, speed, lethality, precision, and the ability to mass fires at a desired time and place. Fixed wing aircraft support

the joint fires tasks of strategic attack, countering air and missile threats (including SEAD and offensive counterair), close air support (CAS) and interdiction.

1-10. **Army Attack Aviation** is executed in support of friendly forces in close enemy contact (i.e., close combat attack) or against enemy forces out of contact with friendly forces. Both can be executed as either hasty or deliberate attacks and are typically supported with integrated joint fires (ATP 3-04.1). US Army attack helicopters can also perform close air support (CAS) in support of another component. The United States Marine Corps (USMC) employs its attack rotary wing aviation primarily as a CAS platform. Attack helicopters can employ precision guided munitions and provide terminal guidance for other weapon platforms. **Unmanned Aircraft (UA)** can support or conduct close combat attack, CAS, strike coordination and reconnaissance, AI, and other joint fires missions. Specific tasks for the UA may include target acquisition and marking, terminal guidance of ordinance, providing accurate coordinates for precision-guided munitions. JP 3-09

## SYSTEM RESPONSIVENESS

1-11. Fire support must be responsive to the needs of the supported commander. Procedures must minimize the time between target acquisition and effects on the target. Delays can result in either failure to engage a target or to create adequate effects on the target. Responsiveness can be achieved by-

- Maximizing the capabilities of computer systems and digital communications during all fire support planning, coordination, and execution.
- Planning fire support requirements in advance.
- Streamlining processing procedures of the call for fire.
- Limiting radio transmissions on fire nets to time sensitive, mission essential traffic only.
- Dissemination of all Fire Support products (for example: fire support coordination measures [FSCMs], airspace coordinating measures [ACMs], Target List Worksheet) to all Fire Support assets.
- Additionally, fire support advance planning must take into consideration factors such as civilian populace, noncombatants, friendly forces, and collateral damage and the employment of various weapons and munitions – bombs, missiles, rockets, artillery, and mortars – in order to determine second and third order effects such as instability, security concerns, and psychological impact in the area of operations prior to initiating fire support execution.

## EFFECTIVE FIRES ON TARGET

1-12. The ability to place effective fires on a target depends in part on the method of fire and type of ammunition selected to attack the target. The desired effect can be created through accurate initial fires and massed fires.

### Accurate Initial Fires

1-13. Observers must strive for first round fire for effect. Figure 1-1 (on page 1-4) compares effect achieved to length of adjustment.

### Massed Fires

1-14. Massing fires normally produces the specific effect on a target with the minimum expenditure of ammunition. It also reduces our vulnerability to adversary target acquisition. Figure 1-2 (on page 1-4) compares massed fire and successive volley ammunition expenditures to get equivalent effects. Massed fires of three battalions firing one round are more effective particularly against soft targets than one battalion firing the same number of rounds in successive volleys. The time interval between volleys gives the adversary time to react and either flee or seek protection.

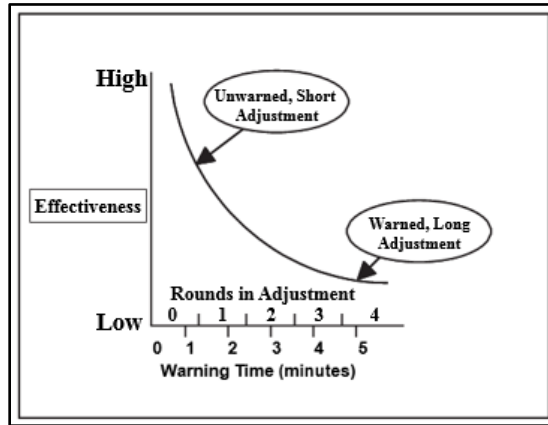

Figure 1-1. Effectiveness compared to length of adjustment

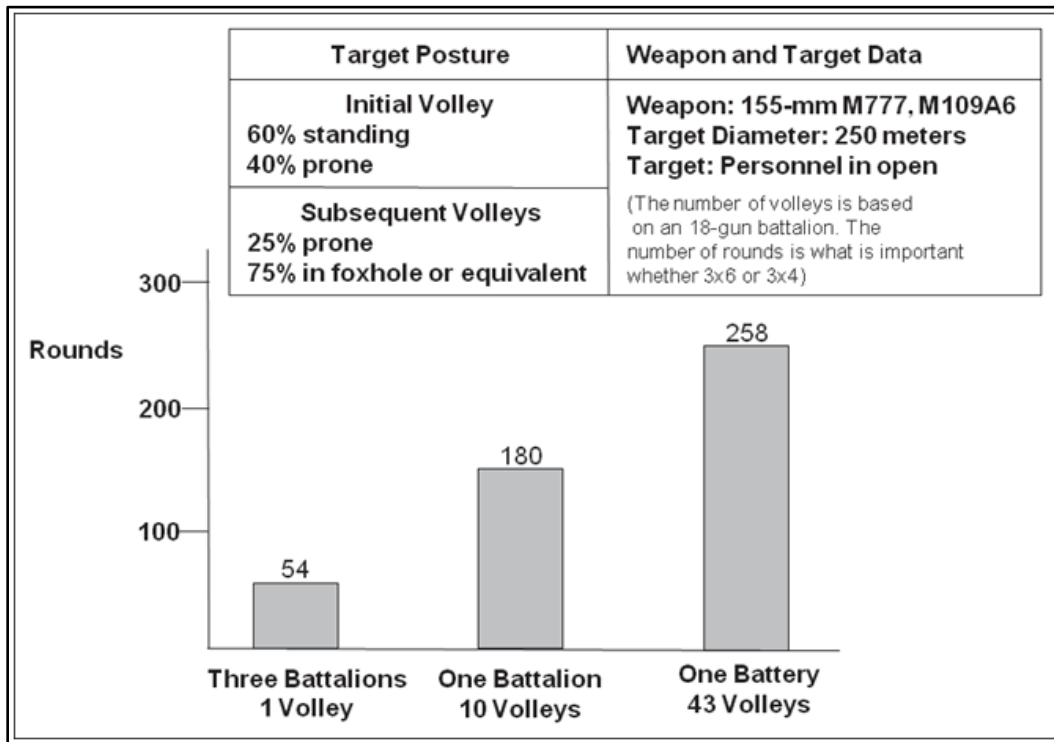
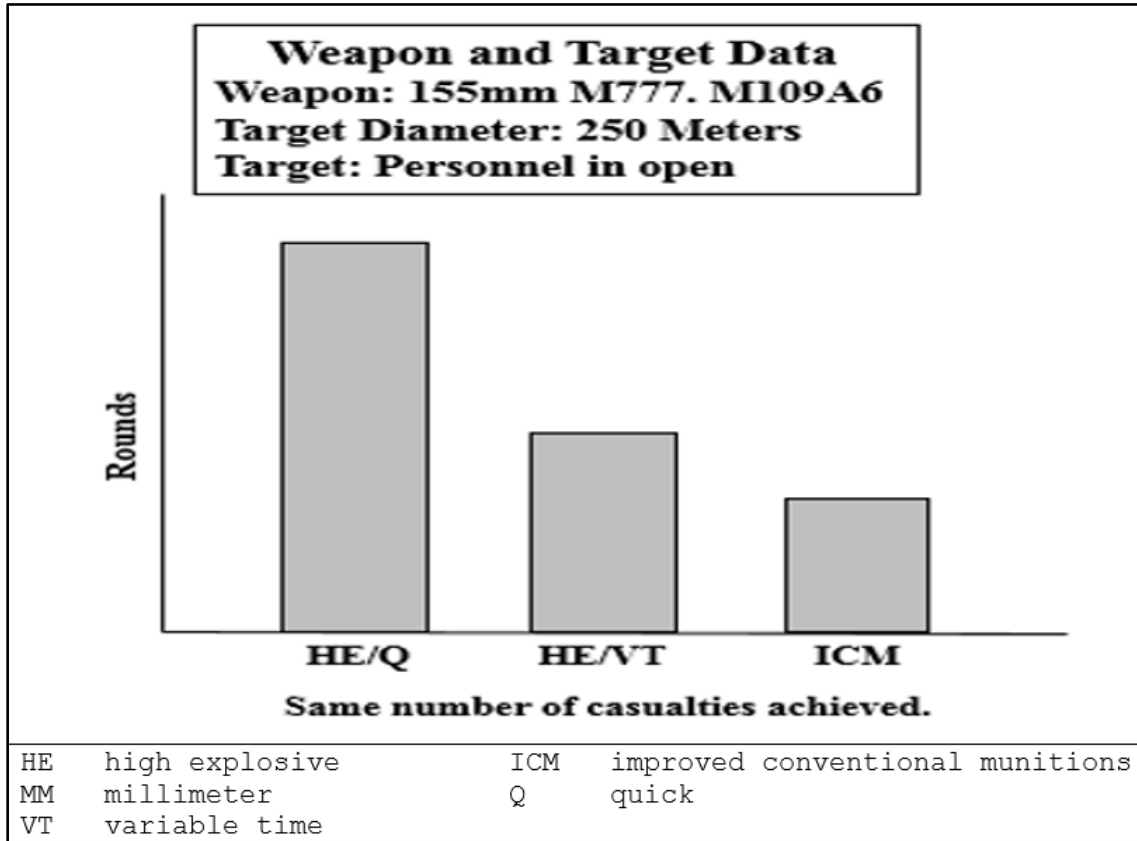

Figure 1-2. Number of rounds required for equivalent effect.

**Proper Munitions**

1-15. In attacking the target, the shell fuze combination selected must be capable of producing the desired results against the most vulnerable part of the target, for example, the gun crew versus the gun. Failure to select proper shell fuze combinations may result in undesired effects on target, a reduction in desired effects on target, or excessive expenditure of ammunition. Figure 1-3 (on page 1-5) compares ammunition expenditures and effects on target.





**Figure 1-3. Ammunition expenditures and relative effects**

### Law of War AND ETHICAL Considerations

1-16. In addition to the above tactical considerations, the selection of targets, munitions, and techniques of fire must comply with the Law of War (LOW), to include but not limited to, Geneva and Hague Conventions regarding prohibited targets weapons, and tactics. The DOD Law of War Manual provides a thorough discussion of the law of war. Trusted Army professionals are expected to make right decisions (i.e. ethical, effective, and efficient) and take actions consistent with the moral principles of the Army Ethic. Targeting of fires in decisive action requires the judicious use lethal force balanced with restraint, tempered by professional judgment. For a summary of how the principles of the LOW and Army Ethic are applied in warfighting, see ADRP 1.

### CAPABILITIES AND LIMITATIONS

1-17. The accuracy of calls for fire depends on the actions and capabilities of observers and company or troop fire support teams (FISTs) and the accuracy of fire support plans. Error free self-location and accurate target location by the observer supports first round fire for effect. First round fire for effect on a target of opportunity and immediate and effective suppression of adversary direct fire systems are essential if the supported maneuver unit is to accomplish its mission. Moreover, accurate location of planned targets is imperative to effective execution of a fire support plan. Accurate location of planned targets requires keeping the adversary under observation by an observer, or other target acquisition asset, and reporting continuous target refinement data to the appropriate headquarters.

1-18. Achievement of these goals is primarily situation dependent. Accuracy of indirect fire support assets (for example field artillery, mortars, and naval surface fire support) also depends greatly on the skill

and experience of the observer who calls for fire and the equipment used to determine self-location and target location.

1-19. Observers equipped with nothing more than a map, binoculars, and compass typically have a mean target location error of about 250 meters. This is not good enough for first round fire for effect or target suppression.

1-20. Attainable accuracy for today's observer teams equipped with optical and electronic devices, such as laser designator and rangefinder and position locating systems, has improved greatly over the past few years. When properly used by trained and qualified observers, these devices assist the observer to attain first round fire for effect accuracy.

**WARNING**

**Lasers have inherently hazardous characteristics. Lasers that are not eye safe can inflict severe eye injury.**

1-21. Each observer party, company or troop fire support officer (FSO), and battalion FSO must ensure the maneuver commander recognizes the capabilities and limitations on attainable accuracy of indirect fire systems and considers this when developing a scheme of maneuver.

## **FIRE SUPPORT PLANNING AND COORDINATION**

1-22. Effective fire support does not happen without prior planning and coordination. The observers must know what their responsibilities are and where they fit into the overall plan.

1-23. The company or troop FSO is in charge of the FIST, and also the principal fire support advisor to the commander when attached to or supporting a company or troop. The FIST plans, coordinates, and executes fire support for the commander's concept of operations. The FSO ensures the scheme of fires fully supports the commander's intent for fire support.

1-24. The maneuver commander has the responsibility to integrate fire support with the scheme of maneuver, and provides the commander's intent for an operation and issues guidance, including guidance for fire support. The FSO translates the guidance into fire support tasks. Each fire support task and purpose directly supports a maneuver task and purpose. The FSO then assigns responsibility of tasks in the Fire Support Plan, assets, and priority of fires, to the observers using all available assets. The FSO ensures dissemination of fire support (FS) products to all supporting assets.

1-25. Overall, the maneuver commander is legally and morally responsible for his decisions and actions. He must work with the Company or Troop FSO and take into consideration the civilian populace, noncombatants, friendly forces, and collateral damage when planning fire support. Members of the Fire Support Team all have the legal and moral obligation to challenge a proposed fire mission if they believe it will violate the Law of War or the moral principles of the Army Ethic. Together they must plan ahead and have the foresight to mitigate and reduce the risk of unintended effects such as excessive collateral damage and negative psychological impacts on the civilian populace and noncombatants – which create or reinforce instability in the area of operations. Improper planning could lead to severe consequences that adversely affect efforts to gain or maintain legitimacy and impede the attainment of both short and long term goals for the U.S. forces commander.

---

*Note.* Risks are always present when employing fires. Everyone involved with the planning, coordinating, and delivery of fires is responsible for evaluating and managing the risks. For more information on risk management see ATP 5-19.

---

## TARGETS

1-26. A *target* is: 1. An entity or object that performs a function for the adversary considered for possible engagement or other action. 2. In intelligence usage, a country, area, installation, agency, or person against which intelligence operations are directed. 3. An area designated and numbered for future firing. 4. In gunfire support usage, an impact burst that hits the target (JP 3-60).

### TARGET OF OPPORTUNITY

1-27. A *target of opportunity* is: (1) A target identified too late, or not selected for action in time, to be included in deliberate targeting that, when detected or located, meets criteria specific to achieving objectives and is processed using dynamic targeting. (2) A target visible to a surface or air sensor or observer which is within range of available weapons and against which fire has not been scheduled or requested (JP 3-60). Targets fit into one of five target types. The five types are:

- Facility: a geographically located, defined physical structure, group of structures, or area that provides a function that contributes to a target system's capability.
- Individual(s): a person or persons who provide a function that contributes to a target system's capability.
- Virtual: an entity in cyberspace that provides a function that contributes to a target system's capability.
- Equipment: a device that provides a function that contributes to a target system's capability.
- Organization: a group or unit that provides a function that contributes to a target system's capability.

### PLANNED TARGET

1-28. A *planned target* is a target that is known to exist in the operational environment, upon which actions are planned using deliberate targeting, creating effects which support commander's objectives. There are two types of planned targets: scheduled and on-call (JP 3-60).

- Scheduled Target. A *scheduled target* is a planned target upon which fires or other actions are scheduled for prosecution at a specified time (JP 3-60). This time may refer to an H-hour or other time reference. However, once established, the scheduled target will have a definite time sequence.
- On-call Target. An *on-call target* is a planned target upon which fires or other actions are determined using deliberate targeting and triggered, when detected or located, using dynamic targeting (JP 3-60). The on-call target requires less reaction time than a target of opportunity.

### Priority Target

1-29. A *priority target* is a target, based on either time or importance, on which the delivery of fires takes precedence over all the fires for the designated firing unit or element (FM 3-09). The firing unit or element will prepare for the engagement of such targets. A firing unit or element may be assigned only one priority target. The designation may be based on either time or importance. The firing unit or element will prepare for the engagement of such targets as determined by the fire support coordinator. The supported maneuver commander designates a priority target based on time requirements or target importance, and provides the FSO specific guidance as to when a target will be a priority target. The commander should also state the desired effects on the target and special munitions to use if applicable. When not engaged in fire missions, firing units lay on priority targets.

### Final Protective Fire

1-30. A type of a priority target in a defensive situation is a final protective fire (FPF). *Final protective fire* is an immediately available prearranged barrier of fire designed to impede enemy movement across defensive lines or areas (JP 3-09.3). An FPF provides continuous fires on a planned target. FPFs should be integrated with maneuver crew served weapons final protective lines.

1-31. When the adversary initiates the final assault into a defensive position, the defending unit initiates its FPFs to kill adversary forces and suppress armored vehicles. Things to remember about an FPF:

- Fire an FPF at the maximum rate of fire until told to stop, ammunition is exhausted, or the firing unit must move.
- The Brigade commander normally allocates field artillery FPFs to the battalion, which may allocate FPFs to company or troop level.
- The Battalion commander normally allocates heavy mortar FPFs to company or troop level.
- The authority to shoot an FPF belongs to the lowest maneuver commander in whose area the FPF is placed or his authorized representative.
- The company or troop FIST has the responsibility to adjust in the FPF when the tactical situation dictates.
- Cancel the FPF when it is no longer required.

1-32. Table 1-1 provides information necessary in planning FPFs. The FPF widths in Table 1-1 are neither precise nor restrictive. The sheaves can be adjusted (see Chapter 6 for sheaf descriptions) to cover the specific terrain on which the FPF is located. Table 1-1 is derived from data on the bursting diameter of rounds. The bursting diameter of a high explosive (HE) round is generally considered to be twice the distance from the point of impact at which the round will reliably place one lethal fragment per square meter of target.

**Table 1-1. FPF planning**

<i>Size</i>	<i>Number of tubes</i>	<i>Approximate Length (meters)</i>	<i>Approximate Width (meters)</i>
<b>Mortars:</b>			
120-mm	4	300	75
120-mm	2	150	75
81-mm (M252)	4	200	50
81-mm (M252)	2	100	50
60-mm	2	60	30
<b>Howitzers:</b>			
155-mm	8	400	50
155-mm	6	300	50
155-mm	4	200	50
155-mm	3	150	50
155-mm	2	100	50
105-mm	8	280	35
105-mm	6	210	35
105-mm	4	140	35
105-mm	3	105	35
105-mm	2	70	35
<b>Legend.</b> mm—millimeter			

## SYMBOLS

1-33. Use standard symbols in the preparation of maps, charts, and overlays to identify targets by type—point, linear, rectangular, circular, FPF, or a target reference point. Figures 1-5 through 1-12 (pages 1-8 through 1-11) illustrate these target symbols. They are keyed to targets on the sample target list work sheet in figure 1-4. See ADRP 1-02 for details on graphic symbols.

*Note.* DA Form 4655 (Target List Worksheet) facilitates fire planning. It is a preliminary list of targets and their descriptions. Fire support personnel recommend targets be added to the fire support plan for the commander's approval.

TARGET LIST WORKSHEET										
( )										
For use of this form, see ATP 3-09.30; the proponent agency is TRADOC.										
SHEET 1 OF 1										
LINE NO	TARGET NO	DESCRIPTION	LOCATION	ALTITUDE	ATTITUDE	SIZE		SOURCE / ACCURACY	REMARKS	
						L	W			
a	b	c	d	e	f	g	h	i		
1	AA3410	82-mm mortars (4 tubes)	14SNG9233443554	340	0440	90	10	1st Plt FO		
2	AA3415	Infantry trench line	14SNG9185256035	410	1600	400	50			
3	AA3420	Aircraft landing strip	14SNG9203345044	250	0800	1200	200			
4	AA3425	Regimental CP	14SNG9476534381	270	Radius	800				
5	AA3430	FPF	14SNG8756868955	370	1660	200				
6	AA3435	Road junction	14SNG8857367012	330						
7										
8										
9										
10										
11										
12										
13										
14										
15										
16										
17										
18										
19										
20										
21										

DA FORM 4655, SEP 2017 PREVIOUS EDITIONS ARE OBSOLETE. AFD LC v1.0E

CP	command post	FO	forward observer
FPF	final protective fire	mm	millimeter
PLT	platoon	TRP	target reference point

Figure 1-4. Sample DA Form 4655, target list worksheet

**Point Target**

1-34. A *point target* is a target that is less than or equal to 200 meters in width and length. Minimum accuracy of the target location on the target list is a six digit grid. See Target AA3411 in figure 1-5.

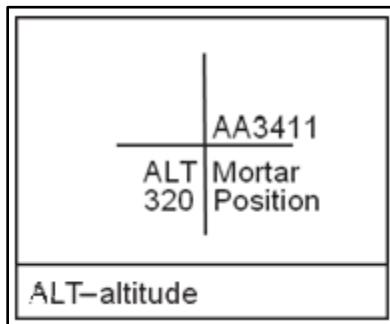

Figure 1-5. Point target

### Linear Target

1-35. A *linear target* is a target that is greater than 200 meters in length and less than or equal to 200 meters in width. A linear target (see Target AA3412 in figure 1-6) is designated by two grids or by a center grid, a length, and an attitude. An *attitude* is the azimuth in mils or degrees, determined to the nearest 100 mils and always less than 3200 mils, measured from grid north to a line passing through the long axis of a linear or rectangular target.

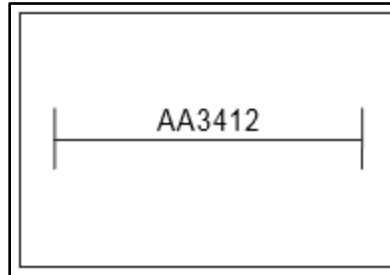

Figure 1-6. Linear target

### Rectangular Target

1-36. A *rectangular target* is a target that is greater than 200 meters in length and width described by four grids or by a center grid, a length, width, and an attitude (see Target AA3413 in figure 1-7).

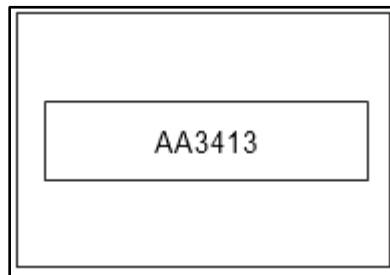

Figure 1-7. Rectangular target

### Circular Target

1-37. A *circular target* is a target that is in a circular pattern or is vague as to exact composition and has a radius greater than 100 meters. It is designated by a center grid and radius greater than 100 meters (see Target AA3414 in figure 1-8).

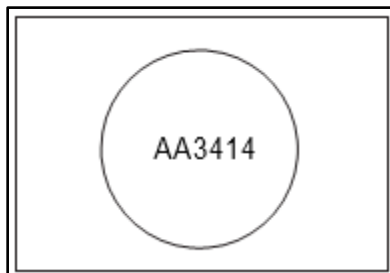

Figure 1-8. Circular target

## Final Protective Fire

1-38. Figure 1-9 illustrates the symbol for an FPF. It includes the target number (see Target AA3415 in figure 1-9), FPF, and optionally, the unit to fire and caliber (120-mm, 155-mm) or type of weapon (mortar, artillery).

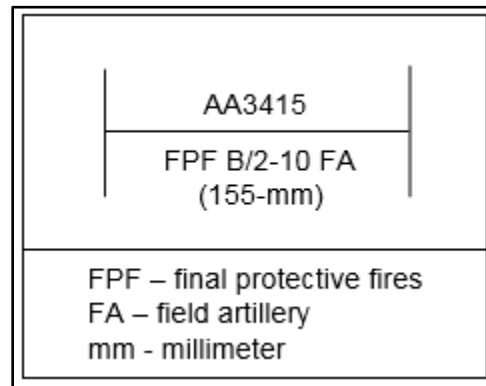

Figure 1-9. Final protective fire

## Target Reference Point

1-39. A *target reference point* is an easily recognizable point on the ground (either natural or man-made) used to initiate, distribute, and control fires (ADRP 1-02). A target reference point can also designate the center of an area where the commander plans to rapidly distribute or converge fires. A maneuver commander designates target reference points for the subordinate elements as necessary to control direct and indirect fires. The echelon's fire support officer can also recommend target reference points become a target by using the standard target symbol and target numbering identification (see figure 1-5 on page 1-9). The target reference point is designated by using a numeric only marking if, and only if, there is no intent to engage with indirect fire. The target indicator in figure 1-10 is an example of a direct fire only target reference point.

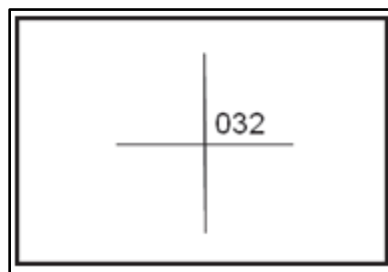

Figure 1-10. Target reference point

## MULTIPLES

1-40. Multiples consist of group of targets, series of targets, and program of targets. In paragraphs below these multiples will be described into further information.

### Group of Targets

1-41. A *group of targets* consists of two or more targets on which fire desired simultaneously. A **group of targets is designed by a letter and number combination or a nickname**. Graphically portray a group of targets by circling the targets and identifying them with a group designator (see figure 1-11). Consider the number of field artillery firing batteries and battalions available when planning groups of targets. Individual targets in a group may be attacked individually.

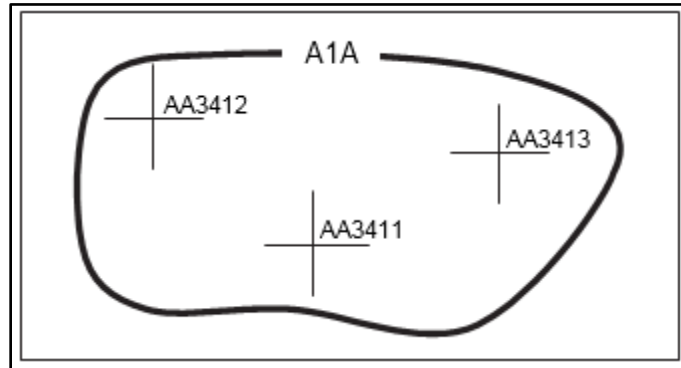

Figure 1-11. Group of targets

### Series of Targets

1-42. A *series of targets* is a number of targets or group(s) of targets planned to be fired in a predetermined sequence to support a maneuver operation. A series may be fired on-call, at a specified time, or when a certain event occurs. The maneuver commander determines the need for a series on the advice of his FSO. The series is indicated by a series name (see figure 1-12 on page 1-12). Individual targets or a group of targets in a series may be attacked individually.

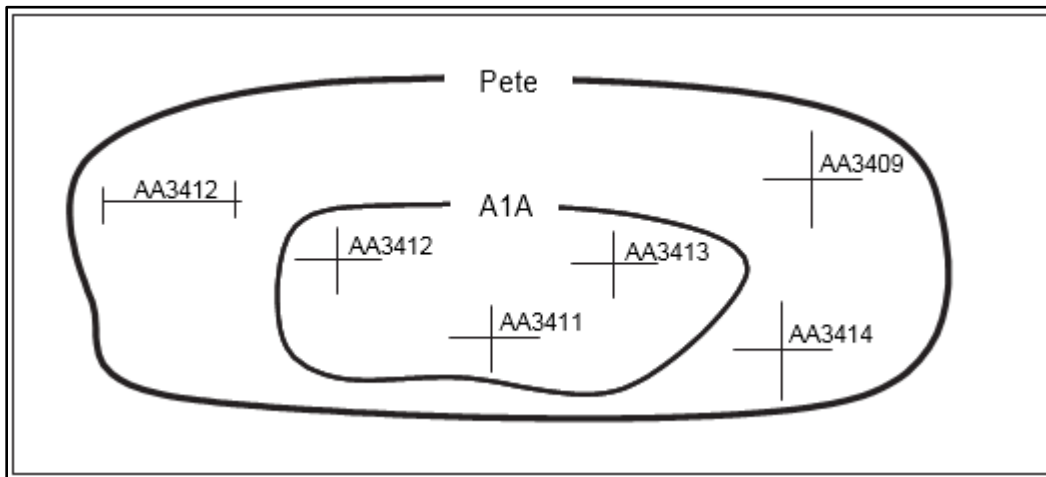

Figure 1-12. Series of Targets

### Program of Targets

1-43. A *program of targets* consists of a number of planned targets of a similar nature that are planned for sequential attack. Execute the attack on-call, at a specific time, or when a particular event occurs. Designate targets by their nature and based on the commander's guidance. For example, in a counterfire program, all the targets are artillery system related: observation posts, artillery batteries, or mortar platoons. Therefore, do not graphically display a program of targets.

### TARGET NUMBERING SYSTEM

1-44. To identify targets, the Army assigns a target number that adheres to the provisions of Standardization Agreement. (STANAG) 2934 (STANAG standards are published by the North Atlantic Treaty Organization (NATO) to provide common military or technical procedures for NATO members). The



target number is comprised of six characters, comprising two letters followed by four number positions such as AB1234. See ATP 3-60 for more information on target numbering.

1-45. The two letter group indicates the originator of the target number and the echelon holding the target data.

1-46. Other than the letter Z, there are no permanently assigned first letters. The senior headquarters for an operation will establish and publish, in orders, the assigned first letter. Coordinate to prevent using identical letters in areas close to adjacent boundaries. Use any letter during training. Units typically establish a target numbering system within their standard operating procedure. The target number prefix "Z" is reserved for technical use by automatic data processing systems among nations. If a target number is not assigned prior to the transfer of target information from one nation to another, the automation system will use a target number beginning with the prefix "Z". The second letter "E", for example "ZE", is allocated for use by U.S. forces in automatic data processing systems in those instances where a "Z" prefix target is generated.

1-47. Target numbers serve as an index to all other information regarding a particular target, such as location, description, and size. Within a major force, a common target numbering system is used. Assigning target numbers in blocks to specific users facilitates tracing a target back to its originating source. For example, the force headquarters may assign the second letter (A through Z) down to brigade level.

1-48. See table 1-2 for an example of standard blocks of numbers within a brigade.

**Table 1-2. Assignment of blocks of numbers (example)**

<b>NUMBERS</b>	<b>ASSIGNED TO</b>
0000-2999	BCT Fires Cell
3000-3999	Fires cell, lowest numbered maneuver battalion or squadron <sup>1</sup>
4000-4999	Fires cell, second lowest numbered maneuver battalion or squadron
5000-5999	Fires cell, third lowest numbered maneuver battalion or squadron
6000-6999	Additional Fires cells or fire support assets
7000-7999	FDC, field artillery battalion
8000-8999	Counterfire targets
9000-9999	Spare
<b>Note.</b> <sup>1</sup> Lowest regimental number	
<b>Legend.</b> BCT—brigade combat team                      FDC—fire direction center                      FSO—fire support officer	

1-49. A battalion or squadron size element with a block of numbers may allocate numbers as shown in table 1-3. Consult the unit standing operating procedure (SOP) for specific unit target numbers.

**Table 1-3. Allocation of blocks of numbers (example)**

<b>NUMBERS</b>	<b>ASSIGNED TO</b>
X000-X199	Battalion Fires Cell
X200-X299	FIST, Company A
X300-X399	FIST, Company B
X400-X499	FIST, Company C
X500-X599	FIST, Company D
X600-X699	Additional FISTs or fire support assets
X700-X799	FDC, battalion or company mortars
X800-X999	Spare
<b>Note.</b> Request additional numbers from the supervising fires cell as needed.	
<b>Legend.</b> FDC—fire direction center                      FIST—fire support team                      X—numeral assigned by higher HQ	

## Chapter 2

# Employing Fire Support

This chapter describes the responsibilities of members of the fire support team (FIST), forward observer (FO) team, and options for employing observers and guidance for selecting and occupying an observation post.

### FIRE SUPPORT TEAM

2-1. The battalion fire support platoons are found in the headquarters battery of each brigade combat team field artillery battalion and normally include FISTs with joint fires observers. The fire support platoons have a habitual support relationship with a specific maneuver battalion or cavalry squadron:

- A *fire support team* is a field artillery team organic to each maneuver battalion and selected units to plan and coordinate all available company supporting fires, including mortars, field artillery, naval surface fire support, army attack aviation, and close air support integration (ADRP 3-09). FISTs employed at company or troop level provide maneuver companies and cavalry troops with fire support coordination, target location, input for terminal attack control, and assessment capabilities.
- A *forward observer* is an observer operating with front line troops trained to adjust ground or naval gunfire and pass back battlefield information. Also called FO. (JP 3-09). Platoon forward observers are equipped with target acquisition devices that assist in accurately locating targets and the communications equipment needed to call for fire and conduct terminal guidance operations (also called TGO). A FO is the primary fire support observer in the company or troop and is frequently collocated with the platoon leader. They provide target refinement, nominate targets to the company fire plan (limited fire planning), advise the platoon leader on all indirect fire support matters; prepare, maintain, and use situation maps, designate targets for precision-guided munitions, report combat information, execute planned fires, and request or adjust fires for their supported platoons.
- Additionally, the FIST works with the maneuver commander via ethical, effective and efficient planning and execution that takes into account proper munitions employment and Fire Support Coordination Measures during targeting and fire support planning. The FIST exercises he judicious use of lethal force balanced with restraint, tempered by professional judgement.

2-2. Although the equipment in each FIST varies depending on the type of force supported, each FIST has a four Soldier team with the personnel shown in table 2-1. A two Soldier FO team is normally authorized for each Stryker and infantry platoon. FO teams are shown in table 2-2 on page 2-2.

**Table 2-1. Fire Support Team Headquarters**

<b>Title</b>	<b>Rank</b>	<b>Quantity</b>
Fire Support Officer	First Lieutenant	1
Fire Support Sergeant	Staff Sergeant	1
Fire Support Specialist	Specialist	1
Radio Telephone Operator	Private	1

Table 2-2. FO Team

<i>Title</i>	<i>Rank</i>	<i>Quantity</i>
Forward Observer	Sergeant	1
Radio Telephone Operator	Private to Specialist	1

## MISSION

2-3. The mission of the FIST is to integrate fires for the supported commander. To accomplish this mission, the FIST is responsible for the tasks discussed in the following paragraphs.

### Fire Support Planning

2-4. Fire support planning is integrated through targeting and the running estimate. Fire support planning includes developing integrated fire plans (target lists, no fire lists, fire support execution matrix, scheme of fires, and overlays) and determining joint fires observer control options that support the commander's scheme of maneuver. To adequately plan and execute the Fire Support Plan, Trusted Army professionals must be leaders of character, competence and commitment. Targeting of fires in decisive action requires the judicious use of lethal force balanced with restraint, tempered by professional judgement. Trusted Army professionals are expected to make right decision (i.e. ethical, effective, and efficient) and take actions consistent with the moral principles of the Army Ethic.”

### Fire Support Coordination

2-5. *Fire support coordination* is the planning and executing of fires so that targets are adequately covered by a suitable weapon or group of weapons (JP 3-09). The FIST must maintain situational understanding at all times and monitor voice requests for fire support within the maneuver element to prevent fratricide, civilian and non-combatant casualties, and ensure that collateral damage is achieved only to the level to achieve mission success, as the result of friendly fire support. The FIST must advise the commander on any fire FSCMs in effect.

### Target Location and Calls for Indirect Fire

2-6. The FIST is responsible for providing an accurate target location and initiating calls for fire or executing planned targets from the fire support plan. See Chapter 4 for further discussion of calls for fire.

### Battlefield Information Reporting

2-7. The observers are the eyes of the field artillery and a major source of information for the fire support community. They forward information to higher headquarters in the form of artillery target intelligence or spot reports. Observers also relay information during each call for fire, including the target description and end of mission surveillance. Observers also relay information such as friendly forces, civilians, and noncombatants in the targeting area to mitigate and prevent the risk of unintended effects and consequences.

### Observe Close Air Support

2-8. The FIST can observe CAS. CAS can be conducted at any place and time friendly forces are in close proximity to enemy forces. The word “close” does not imply a specific distance; rather, it is situational. The requirement for detailed integration because of proximity, fires, or movement is the determining factor. At times, CAS may be the best means to exploit tactical opportunities in the offense or defense. CAS provides fires to destroy, disrupt, suppress, fix, harass, neutralize, or delay enemy forces. JP 3-09.3.

2-9. **Terminal Attack Control (TAC)** is the authority to control the maneuver of and grant weapons release clearance to attacking aircraft. A certified and qualified joint terminal attack controller (JTAC) or forward air controller (airborne) (FAC-[A]) will be recognized across the Department of Defense as capable and authorized to perform TAC. There are three types of control (Types 1, 2, and 3):

- **Type 1 Control**- is used when the JTAC/FAC (A) requires control of individual attacks and the situation requires the JTAC/FAC (A) to visually acquire the attacking aircraft and visually acquire the target for each attack.
- **Type 2 Control**- Type 2 control is used when the JTAC/FAC (A) requires control of individual attacks and is unable to visually acquire the attacking aircraft at weapons release or is unable to visually acquire the target.
- **Type 3 Control**- Type 3 control is used when the JTAC/FAC (A) requires the ability to provide clearance for multiple attacks within a single engagement subject to specific attack restrictions.

2-10. **Coordination.** Once a target has been approved, the JTAC/FAC (A) and command post coordinate the CAS attack with affected ground forces. Cross-boundary clearance of fires, friendly air defense artillery, and CAS aircraft ingress/egress routing must be deconflicted and coordinated.

2-11. **Air support requests** (also called ASR) are used to identify the supported commander's requirements for CAS and other supporting air missions. There are two types of CAS requests: preplanned and immediate. Preplanned air support requests may be resourced with either scheduled or on call air missions. Immediate air support requests are supported with on-call missions or by redirecting scheduled air missions that are already on the air tasking order (also called ATO). (JP 3-09.3)

### Observe Army Attack Aviation

2-12. The FIST can observe for Army attack aviation. The attack aviation call for fire is a combined arms attack TTP conducted by Army Aviation manned and unmanned aircraft maneuvering as a member of the combined arms team to enable friendly ground maneuver forces, in close enemy contact, to gain or maintain a position of relative advantage. The ground maneuver commander in contact controls the synchronization and integration of Army aviation maneuver and the distribution and coordination of Army aviation fires. (ATP 3-04.1)

2-13. Characteristics of an attack aviation call for fire include:

- Conducting fire and maneuver in close support of ground forces.
- Providing complementary fires and maneuver while taking advantage of terrain, standoff, and ground forces for protection.
- Providing reinforcing fires.
- Continuing development of dynamic situation.
- Extending the tactical reach of maneuver forces, particularly in urban and other complex terrain.
- Presenting the enemy with multiple/simultaneous dilemmas from which it cannot escape.
- Establishing and control the operating tempo (OPTEMPO) of the fight.
- Providing extended acquisition range and lethality to the force after contact is made.
- Aviation operational control to ground forces as situation dictates.

### Observe Naval Surface Fire Support

2-14. The FIST can observe for NSFS. The mission of NSFS ship units in an amphibious assault is to support the assault by destroying or neutralizing shore installations that oppose the approach of ships and aircraft, defenses that may oppose the landing force, and defenses that may oppose the post landing advance of the landing force. NSFS provides fire support by naval surface gun, missile, and EW systems in support of a unit or units tasked with achieving the commander's objectives. Naval assets can provide support in a unique manner and should be considered as one source of fire support along with other components and weapon systems.

2-15. When the number of ships permits, individual ships will be assigned as DS to assault battalions. The DS mission establishes the priority in which the ship will process calls for supporting fire and the anticipated ZF. The ship delivers fires on planned targets and targets of opportunity in the ZF, which normally corresponds to the zone of action of the supported unit. When possible, ships capable of performing simultaneous missions will be given a DS mission, to allow for maximum fire support to the forward units of the landing force.

## DUTIES AND RESPONSIBILITIES

2-16. The fire support personnel should be cross trained in each other's duties and responsibilities. The joint fire support officer and joint fire support sergeant must especially understand each other's jobs; the joint fires observers and senior joint fire support specialists prepare themselves to perform the joint fire support sergeant's or even the FSO's duties; and the junior fire support personnel learn each other's duties and any FSO or joint fires observer leader tasks possible.

2-17. Some tasks are team tasks, with responsibilities assigned based on various scenarios and standing operating procedure (SOP) battle drills. As an example, an M7 Bradley fire support vehicle equipped FIST will designate primary operators for the M242, 25-mm gun and M240C coaxial machinegun, and for the eye safe laser range finder and integrated sight unit (to acquire targets) based on a particular situation or battle drill. However all personnel in the FIST must be able to operate and maintain the equipment.

2-18. In some instances, this may require formal training, qualification, or certification. The FSO and joint fire support sergeant must understand all of the training requirements related to the operation of the entire FIST and actively manage and track cross training within the FIST.

2-19. The following paragraphs highlight the major duties and responsibilities of the fire support personnel when under the operational control of or attached to a company or troop.

### Company or Troop Fire Support Officer

2-20. The FSO works for the company or troop commander during combat operations to accomplish all fire support tasks. However, the FSO still remains assigned to the FA Battalion and under the functional supervision of the BN FSO.

2-21. The company or troop commander refines the guidance for fires in the commander's intent and concept of operations. A clearly defined concept of operations enables the commander to articulate precisely the intent of indirect fires to affect the adversary during the different phases of the operation. This allows the joint fire support officer to develop a fire support plan that supports accomplishment of the company's mission. In order to develop an effective fire support plan, the FSO must understand the fires planning process and address all the essential elements of a fire support plan. To help ensure all considerations are addressed, the FSO uses the memory aid FA-PARCA, which means:

- **F-Fire** support tasks, described in terms of a clear task, purpose, and effect.
- **A-Allocation** of assets or targets to subordinate units.
- **P-Positioning** guidance for fire support assets and observers.
- **A-Attack** guidance.
- **R-Restrictions**.
- **C-Coordinating** instructions.
- **A-Assessment** (measure of performance, measure of effectiveness).

2-22. While the maneuver commander is responsible for integrating fire support and maneuver, the FSO must understand the scheme of maneuver as well as the company or troop commander does. The FSO devises the fire support plan based on the commander's guidance and submits the plan to the commander for approval. FSO responsibilities include the following:

- Plan, coordinate, and execute fire support.
- Make recommendations to integrate all fire support assets into the maneuver commander's scheme of maneuver.
- Integrate the fire support plan with the company troop operation order and operation plan and address fire support tasks during rehearsals.
- Keep key personnel informed of pertinent information (by spot reports and situation reports).
- Train the FIST and joint fires observers in applicable fire support matters.
- Initiate calls for fire on targets of opportunity and execute planned targets IAW the fire support plan.
- Prepare and disseminate the fire support plan and or execution matrix to key personnel.

- Advise the company or troop commander on the positioning and use of company or troop mortars.
- Allocate joint fires observers and other observers to maintain surveillance of target and named areas of interest.
- Plan, direct, and manage the employment of observer platforms and laser equipment where they will best support the commander's concept of operation.
- Provide emergency control of CAS and call for and adjust naval surface fire support in the absence of qualified personnel. See ATP 3-09.32 for additional information.
- Ensures that joint fires observers are certified to perform target coordinate mensuration.

### **Company and Troop Fire Support Sergeant**

2-23. The company or troop fire support sergeant or fire support non-commissioned officer (FSNCO) is the senior enlisted assistant to the company or troop FSO. The fire support sergeant must be able to perform the duties of the FSO and act in their absence. The fire support sergeant must:

- Be the subject matter expert on the operations and maintenance of all fire support team equipment.
- Keep key personnel informed of pertinent information (by spot reports and situation reports).
- Advise the FSO on the allocation and tasking of joint fires observers and other observers.
- Train the FIST and forward observers in applicable fire support tactics and techniques.
- Initiate calls for fire on targets of opportunity and execute planned targets IAW the fire support plan.
- Supervise the maintenance of team equipment.
- Supervise the establishment of FIST digital and voice communications.
- At all times during the fire planning and execution process, the Fire Support Sergeant assists the Fire Support Officer by identifying potential targets that may create unintended consequences that are to be excluded as No-Fire areas or zones.

### **Fire Support Specialist**

2-24. The fire support specialist must be able to set up, operate, and maintain all of the equipment of the FIST. The fire support specialist works under the guidance of the fire support sergeant to:

- Establish digital and voice communications.
- Set up, operate, and maintain section equipment.
- Employ all means of fire support.
- Assist in fire support planning and coordination.
- Prepare and maintain staff journals, reports, and map displays.
- Operate and maintain the fire support vehicle.
- Maintain the security of the vehicle during all operations.
- Coordinate for logistics support and resupply.

### **Forward Observer**

2-25. The forward observer is the fire support representative for the maneuver platoon. The FO's primary duty is to accurately locate targets, then call for, and adjust fire support. Additional responsibilities include:

- Use target coordinate mensuration tools.
- Fully understand responsibility within the observation plan and provide refinement or submit key targets for inclusion in the company or troop fire plan.
- Prepare, maintain, and use situation maps.
- Establish and maintain digital and voice communications with the company or troop FIST.
- Advise the platoon leader as to the capabilities and limitations of available fire support.
- Report combat information.

- Provide target information for army attack aviation and CAS execution, and naval surface fire support.
- Must apply the law of war and rules of engagement (ROE) when employing fire support.

### Radio Telephone Operator

2-26. The radio telephone operator (RTO) operates and maintains the digital and voice communications equipment of the FIST or a forward observer party. As a member of the FIST or the forward observer party, he must be able to perform the duties of the fire support specialist in the FIST or of the forward observer. He works under the guidance of the fire support sergeant to:

- Set up, operate, and maintain radios and digital devices.

2-27. Perform position improvement tasks under the direction of the fire support sergeant.

- Forward all reports to higher headquarters as per SOP.

### Joint Fires Observer

2-28. A *joint fires observer* is a trained Service member who can request, adjust, and control surface-to-surface fires, provide target information in support of Type 2 and 3 close air support terminal attack control, and perform autonomous terminal guidance operations (JP 3-09.3).

2-29. The joint fires observer is not an addition to the Army fire support organization, but rather a Soldier who has received the required additional training for initial joint fires observer certification and who has maintained qualification through currency and evaluation requirements. Typically a Soldier who has progressed from being an RTO, and is chosen to serve as a Forward Observer because of the individuals' knowledge and experience. This is commonly determined by the company or troop fire support sergeant and FSO. For additional information see TC 3-09.8.

2-30. To facilitate CAS attacks, the joint fires observer is specially trained to provide timely and accurate target information to a qualified JTAC or FAC (A), or directly to supporting CAS aircraft when authorized by the controlling JTAC or FAC (A).

---

*Note. Terminal guidance operations* are those actions using electronic, mechanical, voice, or visual communications that provide approaching aircraft and/or weapons additional information regarding a specific target location. Also called TGO (JP 3-09)

---

## FIRE SUPPORT TEAM OPTIONS

2-31. There are 3 options that are used to employ the fire support team. Under mission command, the Battalion FSO and maneuver commander will decide which option to employ the FIST depending on the type of operation and degree of mutual trust and cohesion between team members and their supported maneuver commanders. The Battalion FSO is responsible for giving the maneuver commander his professional advice as to which option choose, or a modified version of these three options, depending his level of trust about the capabilities of the individual elements of the FIST. The greater the level of trust the less control is recommended.

### Option 1 – Battalion Fire Support Team

2-32. Consolidate FISTs at the battalion level to maximize the battalion commander's ability to influence the battle at a critical time and place. Company or troop commanders may retain access to fire support expertise in the planning process while the FISTs are centralized at the battalion level for execution.

### Option 2 – Company or Troop FIST

2-33. FIST assets remain at the company or troop level for fire support planning, coordination, and execution.



**Option 3 – Platoon Forward Observer: IBCT, ABCT, SBCT**

2-34. Most platoons in the maneuver companies or troops receive a forward observer.

2-35. **IBCT**-In an Infantry brigade combat team the FO teams in the rifle companies are split and assigned individually to the rifle platoons. The RTO assumes duties as an FO in the absence of one and can act independently for the platoon assigned when required. The FIST is decentralized from the company and its enlisted members are designated as FOs. The FSNCO and two Fire Support Specialists from the FIST headquarters (HQ) remain in the FIST headquarters platoon performing FIST HQ operations. The FSO remains at the company headquarters to provide fire support to the commander. The FIST in the weapons company can designate individuals from the FIST as platoon FOs, however due to TOE allocations they will be extremely limited in employing this option fully and will be able to only man 3 platoons in the company with an FO, leaving the FSO solely to perform duties in the FIST HQ.

2-36. **Cavalry Squadron** – FO teams in the dismounted cavalry troop are assigned to the 2 dismounted platoons within the troop. The FIST remains centralized to the troop and performs FIST HQ operations. The FSO remains at the troop headquarters to provide fire support to the commander.

2-37. **ABCT**-In an Armored brigade combat team, the Combined Arms Battalion's (also called CAB's) the FO teams in the rifle companies are split and assigned individually to the 3 platoons. The RTO assumes duties as an FO in the absence of one and can act independently for the platoon assigned when required. The FIST is decentralized from the company and its enlisted members are designated as FOs. The FSNCO and two Fire Support Specialists from the FIST headquarters (HQ) remain in the FIST headquarters platoon performing FIST HQ operations. The FSO remains at the company headquarters to provide fire support to the commander. The FIST in the Armor companies can designate individuals from the FIST as platoon FOs, however due to TOE allocations they will be extremely limited in employing this option fully and will be able to only man 3 platoons in the company with an FO, leaving the FSO solely to perform duties in the FIST HQ.

2-38. **Cavalry Squadron** – The FIST in the troops can designate individuals from the FIST as platoon FOs, however due to TOE allocations they will be extremely limited in employing this option fully and will be able to only man 3 platoons in the troop with an FO. The FSO will remain at the troop headquarters to provide fire support to the commander.

2-39. **SBCT**-In a Striker brigade combat team (SBCT) the Infantry Battalion FO teams in the rifle companies are split and assigned individually to the three platoons. The RTO assumes duties as an FO in the absence of one and can act independently for the platoon when required. The FIST is decentralized from the company and its enlisted members are designated as FOs. The FSNCO and two Fire Support Specialists from the FIST headquarters (HQ) remain in the headquarters platoon performing FIST HQ operations. The FSO remains at the company headquarters to provide fire support to the commander.

2-40. **Cavalry Squadron** – The FIST in the troops can designate individuals from the FIST as platoon FOs. The FO's are the primary observers in the troop. They are normally collocated with the platoon leaders. The FIST remains centralized to the troop and performs FIST HQ operations. Forward observers provide target refinement; execute planned fires, and request fires for their supported platoons. The FSO will remain at the troop headquarters to provide fire support to their commander.

2-41. **Weapons Troop** - The FIST in the troop can designate individuals from the FIST as platoon FOs, however due to TOE allocations they will be extremely limited in employing this option fully and will be able to only man 3 platoons in the Troop with an FO. The FSO will remain at the troop headquarters to provide fire support to the commander.

## **FORWARD OBSERVER CONTROL OPTIONS**

2-42. The FIST team, like all Army organizations, operate under mission command (ADRP 6-0). The philosophy of mission command is built on the principles of building mutual trust and cohesion, creating shared understanding of the commander's intent, provided through mission orders, and the exercise of disciplined initiative after assessing accepting prudent risk. The exercise of Mission Command applies internally to fires organizations and fires leaders, and externally requires mutual trust and shared understanding of both the situation and supported maneuver commander's intent. Selection of the option for how to employ the FIST team is decision not be taken lightly. The FSO must consider the degree of mutual trust they have with each member of the team. The greater the FSO assessment of their shared understanding and trust, the less control and greater decentralization of decision making delegated to FOs. To build that trust prior to deployment in training is essential, but it can be established and strengthened during operations as well. The FSO must ensure that the Forward Observers clearly understand the rules of engagement, are trained in the moral principles of the Army Ethic, understand targeting plans, are familiar with the entire fire support plan, and that they have identified contingencies, and the FOs are continuously reviewing targets in the AO real time, relaying back any target changes. FOs must know what actions to take if target changes jeopardize friendly forces, civilians or non-combatants. In all options, the Fire Support Officer retains responsibility for the actions of their Forward Observers, each of whom is accountable for their own decisions.

### **Option 1 – Decentralized**

2-43. The forward observer may call for fire from fire support assets available to support the operation. This option gives the most responsive fires; however, it allows the FIST the least amount of control. Allowing the forward observer to determine which asset should engage each target requires a highly trained observer and FSO. This option gives the observer the most autonomy. This method is best employed by FO teams that have the highest degree of experience and training. If an FO team is inexperienced there may be a greater risk of fratricide. More importantly, if an FO team is inexperienced, ill-trained, ill-informed, and/or lacks discipline then the probability for creating negative unintended consequences will be greater, especially when factors such as civilians and non-combatants. Friendly forces, and non-essential targets may interfere with the fire support execution and judgement of FO team.

### **Option 2 – Designated**

2-44. The forward observer is assigned a particular fire support asset from which the FO may request fire support. The forward observer transmits calls for fire on the assigned unit's net. If the forward observer thinks a target requires a different fire support asset, the FO must request permission from the FIST to change assets. Permission is granted on a mission by mission basis. Under this option, fire support is highly responsive if the asset is suitable to the type of target.

### **Option 3 – Centralized**

2-45. The forward observer must contact the FIST for each call for fire. The FIST refers the observer or relays the request to an appropriate fire support asset. This option is least responsive for the observer, but it offers the highest degree of control to the FIST. Use this option for inexperienced FO teams or when non fire support personnel are observers for their platoon. This option is the most labor intensive for the FSO and FIST. FSOs and commanders should take into account other mission requirements of the FIST before employing this option. Additionally, if relaying a call for fire, this option introduces a greater possibility of transcription errors in voice communication.

## **FORWARD OBSERVER TAILORING**

2-46. Since the level of trust in the character, competence, commitment, and the tactical situation vary for each observer, the company or troop FSO may assign each observer under the FSO's control an appropriate option. For example, the 1st Platoon forward observer may be decentralized, the 2nd Platoon forward observer may be designated, and the 3rd Platoon forward observer may be centralized.

## VEHICLE EMPLOYMENT OPTIONS

2-47. The manner in which a maneuver commander organizes and uses the FIST assets will vary depending on the mission variables. The company or troop FSO advises the maneuver commander as to the means of employment that will best allow the FIST to accomplish its tasks. The three options are:

### Option 1 –Control

2-48. Position the FSO in the fire support vehicle to support the scheme of maneuver and to control indirect fires while remaining near the commander. Locate the fire support vehicle where the FSO can effectively observe and control execution of the fire support plan. This option allows the FSO to conduct required fire support coordination and maintain contact with the commander's vehicle for face to face coordination when needed. The fire support vehicle should not be immediately next to the commander's vehicle; rather, it should be within visual range.

### Option 2 – Observation

2-49. Position the fire support vehicle to support the company or troop on terrain to maximize the use of the laser designator and rangefinder. The FSO rides in the commander's vehicle. This option allows the FSO to maintain close coordination with the commander. However, the FSO's ability to observe fires and control the execution of the fire support plan is limited.

### Option 3 – Independent Observer

2-50. This option maximizes assets available to the battalion or brigade commander and best allows the maneuver commander to weight the main effort. This may degrade fire support to the supported unit by taking away the fire support vehicle and half of the fire support communications capability.

## JOINT FIRES OBSERVER MANNING

2-51. Joint fires observers (JFOs) are typically found on fire support teams, but may also be trained to fill positions in scout platoons, teams, or others as identified by commanders. JFO's are positioned and employed in the same manner as forward observers and they are normally positioned at the lower tactical levels (for example, company, or platoon). During operational planning, commanders must evaluate options for integration of joint fires, provide clear guidance on the intent for fires and effects, and provide a risk assessment determination identifying guidance for types of CAS terminal attack control. Units that have a reasonable expectation to conduct CAS have a responsibility to employ and position qualified terminal attack controllers, either JTAC or FAC (A), in that role. JFOs are supported by assets available from the company or troop, battalion or squadron.

2-52. JFOs are located at the platoon level. They normally report to the company fire support officer or fire support noncommissioned officer. The JFO may be collocated with the platoon leader, or with the scouts. The JFOs will monitor the company or troop fires net and possibly the battalion or squadron fires net, depending on unit standard operating procedures.

## JOINT TRAINING

2-53. Many air support operations squadrons provide high quality joint fires integration familiarization and training programs in the home station environment. i.e. Joint Theater Air Ground Simulation System (JTAGSS), the Air Support Operations Center (ASOC) trainer, and the Joint Terminal Control Training and Rehearsal System (JTC TRS) Dome, known as the "JTAC Dome" for training JATCs. Joint training between Division Fires Cells and the ASOC, as well, JTACs and JFOs is encouraged whenever possible. Together they are able to train and employ as an effective joint tactical team for the entire spectrum of conflict.

2-54. To maximize the effectiveness of joint fires supporting maneuver, the JFO must be employed deliberately through proper planning, preparation, and execution. Effective joint fire support depends on planning for supporting maneuver forces in contact, supporting the maneuver concept of operations, and synchronizing the various elements of joint fire support operations (for example, observation, battlefield intelligence, air operations, surface and naval fires). Planning must include JFO equipment capabilities to

support troops in contact and the maneuver concept of operations, particularly communications and target location equipment. JFO positioning must also be specifically addressed in the observation plan to maximize coverage in synchronization with JTACs and other observation assets. During operations, the JFO must be prepared to execute through inclusion in rehearsals for fire support, combined arms, and joint CAS. During mission preparation, the JFO should be equipped with operation materials common to the fires cell and TACP, such as special instructions (also called SPINS), communications plans, maps, grid reference guides, and the commander's intent for fires and effects. During execution, the JFO can provide real-time situation updates and target information as well as battle damage assessment of joint fires' effects. An example of this is on figure 2-1.

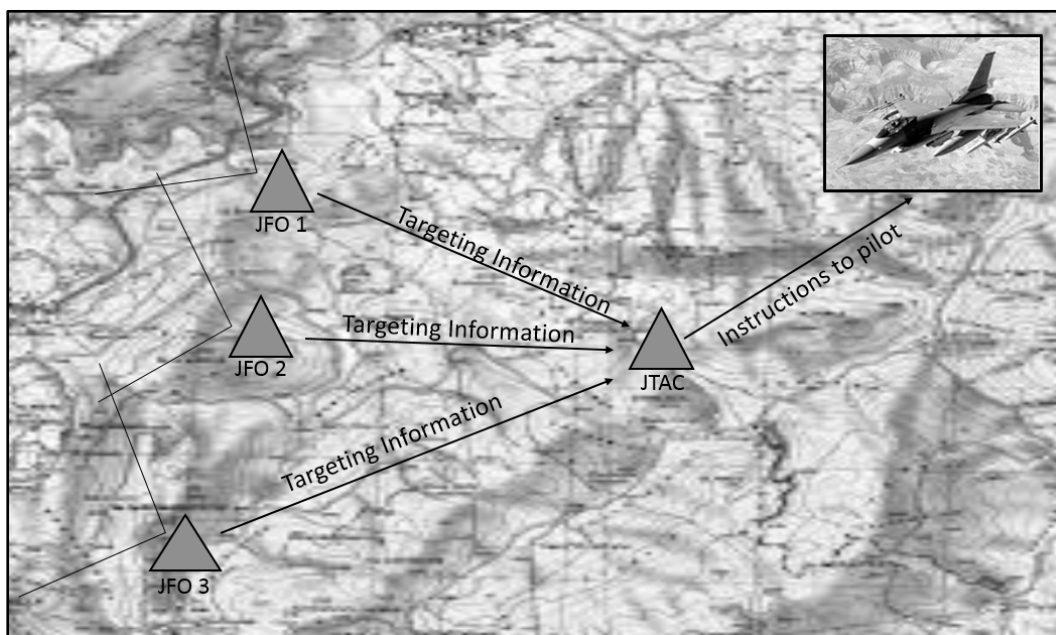

**Figure 2-1 JFO-JTAC Employment Example**

2-55. Personnel authorized to perform JFO duties—

- Must be a graduate of a primary duty skill identifier and additional skill identifier producing school.
- Must be designated in writing by the first Lieutenant Colonel (O-5) or higher in the unit chain of command.
- Must maintain qualification as described in TC 3-09.8 and the JFO Memorandum of Agreement (also called MOA).

## JFO EXECUTION FUNDAMENTALS

2-56. The JFO is trained to push information in a standardized format to facilitate joint fires execution; however, the JFO must also be able to respond to time-sensitive requests from JTACs or fires leadership needing to pull specific information. Within an Army fire support team, JFO and FO actions provide the “detect” and initial assessment steps in targeting’s decide, detect, deliver, and assess steps. For joint targeting, a JFO’s actions feed into the “find, fix, track, target, engage, and assess” process used for dynamic targeting and close air support (see JP 3-60). A good technique for a JFO to facilitate joint fires is to accomplish a continual cycle of observing, reporting, coordinating, preparing, executing, and assessing—

- Observe the JFO’s planned area of responsibility for battlefield updates and potential targets.
- Report situation to fires cell (in accordance with communications plan), and continually update the situation report as required. Techniques to provide battlefield updates include the memory

aid Size, Activity, Location, Time (SALT) report or the similar aid Size, Activity, Location, Uniform, Time, Equipment (SALUTE) report, but report format will be unit-dependent.

- Coordinate the proper use of joint fires assets with the fires cell. This may also include requesting additional joint fires assets, such as CAS aircraft and or naval surface fire support, as the situation dictates.
- Prepare accurate target information to facilitate the coordinated fires and assist in the integration of joint fires, as required.
- Execute by providing timely and accurate target information through calls for fire and or CAS briefings.
- Assess the effectiveness of fires and report to the fires cell, JTAC, and or aircrew. This assessment may require coordination for additional fires.

2-57. **Develop Game Plan.** The game plan, at a minimum, will contain the type of control and method of attack. In addition, the following can be part of the game plan or passed in remarks: the ground commander's intent, the ordnance effects desired, or the ordnance and fuze combination required, if known. Aircraft interval can also be specified by the JTAC.

2-58. **Game Plan.** The JFO monitors the game plan to provide the ground commander with pertinent information.

2-59. For each attack the JFO should know which aircraft will be attacking, the weapon to be employed, as well as the following depending on the weapon:

- Laser pulse repetition frequency code for laser-guided weapons,
- The JFO's role in terminal guidance of laser weapons (that is, primary, secondary, or tertiary laser designator) and who is providing directives via joint laser brevity,
- System readback is mandatory for all Bomb on Coordinate (also called BOC) attacks,
- Aimpoint or system read-back for global positioning system (GPS) or inertial guidance-aided munitions attacks.

---

**NOTE:** The JTAC provides a readback to the JFO of all mandatory readback items or recommended final attack headings and directions. If the JTAC does not concur with the JFO's restrictions, the JTAC will brief the JFO on updated restrictions and the reason for the change.

---

## MISSION EXECUTION

2-60. The JFO should be kept informed as the mission progresses. The JFO must know CAS mission specifics that may include when aircraft are prosecuting attacks, how many aircraft are attacking the target, when they release ordnance, and approximate time of weapons impact:

2-61. During mission execution, the JFO will pass pertinent information to the JTAC, while maintaining communications with the on-scene maneuver commander. This includes, but is not limited to:

- Target updates, target location refinement, target movement, and change in target priority.
- Troops in contact.
- Friendly location updates and maneuver plan after the attack.
- Collateral damage considerations and updates.
- Weapons impact correction and new desired aim point. The JTAC should be proactive and ensure the JFO provides timely corrections.
- Threats to aircraft enemy surface-to-air missile, small arms, and antiaircraft artillery equipment.
- Inputs to battle damage assessment.

## OBSERVATION POST

2-62. An *observation post* is a position from which military observations are made, or fire directed and adjusted, and which possesses appropriate communications. While aerial observers and sensors systems are extremely useful, those systems do not constitute aerial observation post (FM 3-90-2).

### SELECTION

2-63. Consider the following when selecting an observation post:

- The observation post must permit the observer the ability to accurately identify and locate assigned targets based on the fire support plan.
  - Observe targets in the supported unit's area of operation (identifiable points on the ground).
  - Evaluate the effects of fire created on targets.
  - Cover obstacles with indirect fire.

---

*Note.* The supported maneuver unit should always keep obstacles under surveillance and be able to call for fire through the supporting FIST. An obstacle not observed and covered by fire is no obstacle at all. The company or troop FSO must check with the maneuver commander to ensure obstacles are under surveillance and emphasize that requirement during rehearsals.

---

- Coordinate observation post selection with other observers' observation posts and maneuver observation posts to prevent and minimize gaps or dead space.
- Ensure the observation post is not vulnerable. Observation posts are vulnerable to identification from the air by loose dirt, wire lines, paths to the position, and detection of antennas.
- Select a position that enhances survivability through concealment.
- Select an observation post that can accommodate establishing and maintaining communication.
- Observation posts should have an entry and exit route that permits occupation without arousing suspicion of the adversary.
- Use elevated points such as crests, but avoid landmarks and prominent terrain features. Consider the characteristics of forward slope positions (military crest) versus those of the reverse slope.

### FORWARD SLOPE CONSIDERATIONS

2-64. Consider the following when positioning an observation post on a forward slope:

- It should offer views to the front and flanks.
- Fires impacting on the topographical crest will not neutralize the position.
- A hillside provides background and aids in concealment.
- Occupation during daylight is difficult without risking disclosure of the position.
- Radio communications may be difficult.
- The position should provide cover from direct fire.

### REVERSE SLOP CONSIDERATIONS

2-65. Positioning an observation post on a reverse slope:

- Allows occupation during daylight.
- Allows greater freedom of movement over forward slope.
- Facilitates installation and concealment of communications equipment.
- Provides protection from direct fire.
- Affords limited field of view to the front.
- Enemy fire landing on the topographical crest may neutralize the observation post.

## TACTICAL OCCUPATION OF AN OBSERVATION POST

2-66. The memory aid SLOCTOP, which stands for security, location, communication, targeting, observation, and position improvement is used for occupying a position. For more detailed information see TC 3-09.8, chapter 3.

2-67. Many of the following techniques are extremely valuable, but time intensive, and more commonly used during static actions such as defensive operations.

### S – Security

2-68. Before occupying the observation post, conduct a reconnaissance of the surrounding area.

2-69. Ensure the reconnaissance covers 6,400 miles with a 500 meter radius around the tentative observation post location.

2-70. Ensure that the reconnaissance party does not silhouette themselves during the reconnaissance: exercise full camouflage, noise and light discipline, and tactical movement during all phases of the observation post occupation.

### L – Location

2-71. Upon completion of the reconnaissance they will finalize the exact observation post location. Degree of accuracy for self-location must be within 10 meters when using electronic location devices (such as Global Positioning System [GPS] assisted locators or laser designators and rangefinders) and within 100 meters if the observer must estimate their location from a map.

2-72. Select a position that is not sky lined or easily identifiable as an observation post (military crest, 2/3 up, on nondescript high ground).

2-73. The team should prepare its observed fire fan for use and begin the terrain sketch.

2-74. Update the observer's situation map with all current friendly units, known or suspected adversary positions, and graphic control measures.

2-75. Send the team location to the fires cell, artillery or mortar FDC and supported maneuver organization.

### C – Communication

2-76. Communication is the number one priority for the team. Establish communications during the security and location phases of the memory aid SLOCTOP.

2-77. Communication is the most valuable resource for developing situational awareness during occupation. Ensure a member of your team records all information (other missions; position updates; size, activity, location, unit, time, and equipment reports) in order to assist a smooth transition from a mobile to a static observation posture.

2-78. Distorted or nonexistent communications may necessitate changing locations, attaching the ten foot whip or larger antenna, or using a field expedient antenna ensuring concealment of the equipment.

2-79. Update higher headquarters (both maneuver and fire support) with the most current observer location and other relevant information such as the enemy situation.

### T – Targeting

2-80. Locate targets using the most accurate and expedient means available, incorporate the targets into the terrain sketch.

2-81. Conceal the laser designator and rangefinder and operate all lasing devices within safety parameters.

2-82. Affix the night and thermal device near the laser designator and rangefinder as soon as possible. (Although it may be daylight, the night and thermal device may be able to see through smoke and other obscurations.)

**O – Observation**

- 2-83. Ensure all team members are proficient in friendly or adversary forces recognition.
- 2-84. Clear the fields of view.
- 2-85. Refine company or troop targets and those assigned by higher headquarters.
- 2-86. Identify trigger points, target reference points, and review the engagement criteria. Ensure all team members understand this information.
- 2-87. Plan to sustain 24 hour operations. Ensures all team members are proficient in the ROE with regards to protection of civilians and non-combatants on the battlefield and balance judicious use of lethal force with mission accomplishment.

**P – Position Improvement**

- 2-88. Dig in the position and establish a parapet. Use regional foliage and items organic to the area to ensure a "natural" look to the position is preserved. If possible, view the observation post from adversaries' point of view.
- 2-89. Improve camouflage; erect a camouflage net if possible.
- 2-90. Adhere to unit SOPs for conduct on the observation post rotation schedule, placement and use of latrine, and eating procedures.
- 2-91. Conduct continuous position improvement. Specific areas for concentration are security, noise and light discipline, weapons and equipment maintenance, camouflage, and communications.
- 2-92. Verify an alternate observation post provides cover and concealment and adequate target area observation.



## Chapter 3

# Target Location and Identification

Indirect fires are different from direct fires because the observer is not the one doing the shooting. The observer must accurately describe the location of the target in terms that the shooter can understand and use. Most commonly, the target location involves a grid reference system known to the observer and shooter. The observer must use the most accurate means available to locate the target. Additionally, the observer must properly identify the target before engaging it. The degree of identification required depends on the rules of engagement.

### INTRODUCTION TO TARGET LOCATION

3-1. To perform their duties successfully, the observer must be able to determine an accurate target location. The observer will always use the most accurate means available for determining target location to achieve first round fire for effect.

### TARGET LOCATION TOOLS

3-2. The fire support personnel are provided with various automated means of determining accurate target locations. The use of automated target location tools is the preferred method of establishing accurate target location. These tools include a targeting device or an automated targeting device, a forward entry device, and imagery based mensuration tools.

---

Precision target location equipment should always be used the primary means to determine the targets location. The observer should verify data using analog equipment (map, binos, and compass), but not to use as a primary means unless unable to utilize due to a degraded status.

---

### Targeting Device

3-3. The observer may have an optical device using a laser range finder for distance and an Azimuth Vertical Angle Module to acquire direction and vertical angle.

### Automated Targeting Device

3-4. An automated targeting device is an electrical device that uses technology to aid the operator in determining an accurate target location. An example of capabilities of an automated targeting device is using a laser range finder for distance, a Precision Azimuth Vertical Angle Module to acquire a non-magnetic direction and vertical angle, and a Selective Availability Anti-Spoofing Module compliant Global Positioning System. When using automated targeting devices, transmit the target location error (TLE) in the target location portion of the call for fire request.

### Forward Observer Digital System

3-5. The forward observer digital system is a digital device that can receive either relative target location or absolute target location from a targeting device or have target data manually entered that transmits the fire support related messages digitally to other automation systems enabling mission command.

### Imagery Based Mensuration Tools

3-6. *Mensuration* is the process of measurement of a feature or location on the earth to determine an absolute latitude, longitude, and elevation (JP 3-60). Mensuration is accomplished through the application of mathematical principles to a two dimensional surface in order to determine the most accurate location of a target on all planes of a three dimensional surface. Imagery based mensuration tools are usually loaded on the observer's forward observer digital system. An imagery based mensuration tool uses multiple forms of national and tactical imagery to refine coordinates for the use of both precision-guided munitions and conventional munitions.

3-7. There are several combinations of ways to use the target location tools available to the observer. For optimal effects an observer should use a precision targeting device to acquire the target and transmit to the forward observer digital system, then refine the target with an imagery based mensuration tool while populating other parts of the call for fire before transmitting the mission to higher.

3-8. The most accurate method to determine a target location is through target coordinate mensuration. The observer has the capability to determine a less than 6 meter TLE using imagery loaded onto a forward observer digital system. Other electronic devices, such as a GPS and a laser designator and rangefinder, can aid in determining an accurate location. When used in conjunction with digital imagery, the observer's target location accuracy is enhanced. However, an observer should always verify the reliability of the target location through another means, such as terrain map association.

### ACCURATE TARGET LOCATION

3-9. Accurate target location is critical to achieving first round effects on targets. The use of position locating systems, mensuration tools, and laser designators and rangefinders operating from known locations are critical to accurately locating targets and achieving first round fire for effect. When these capabilities are not available and the observer is operating in a degraded mode, the observer must rely on thorough terrain map study to accurately locate targets. Frequently in these degraded situations, the observer is unable to accurately locate targets and must correct errors in target location by adjusting fires onto a target, thereby forfeiting surprise and effects on target.

3-10. Using large scale maps (larger than 1:100,000) may make terrain map association difficult. In these situations, the use of position locating systems or other navigational aids is essential for observer self-location and the accurate location of targets.

3-11. Accurate target location is not only required for precision-guided munitions but also for every fire mission. The goal for every observer is to provide the most accurate target location (including elevation) possible by using the full range of capability and equipment.

3-12. In order to consistently determine an accurate target location, a good observer-

- Must be able to determine an accurate target location through mensuration using current target location tools.
- Must be able to self-locate to within 10 meters (100 meters if degraded by lack of position locating systems or other navigational aids).
- Uses prominent terrain features to relate potential target areas to grid locations on a map.
- Makes a thorough study of terrain by drawing a terrain sketch (in a static location).
- Associates the direction in which the observer is looking with a direction line on the map.
- Must be able to use electronic navigational aids with map analysis verification.

### TARGET COORDINATE MENSURATION

3-13. *Target coordinate mensuration (TCM)* is the process of measurement of a feature or location on the earth to determine an absolute latitude, longitude, and elevation. TCM is a process that provides personnel the capability to refine targeting coordinates using imagery. Mensuration aims to produce a target location error (TLE90) < 6 meters. Target coordinate mensuration is the preferable targeting technique for precision-guided munitions.

3-14. The use of fire support digital systems such as the pocket sized forward entry device with precision fires imagery (PFI) and Forward Observer System (FOS) with Precision Strike Suite Special Operations Forces (also called PSS-SOF) working in conjunction with laser designators and rangefinders that are operating from known locations can greatly reduce target location error. These systems can achieve a < 6m TLE to support the employment of coordinate seeking weapons.

---

*Note.* Personnel performing target coordinate mensuration must be certified through a National Geospatial Intelligence Agency accredited Service, combatant command, or supporting agency program, in accordance with Chairman of the Joint Chiefs of Staff Instruction (CJCSI) 3505.01C. There are two programs under target coordinate mensuration-Target Material Production, and Target Mensuration Only.

---

## DIRECTION

3-15. The standard U.S. large-scale military map is 1:50,000; however, many areas have been mapped at a scale of 1:25,000 or 1:24,000). Using medium scale (scales between 1:75,000 and 1:1,000,000, typically 1:250,000 or 1:100,000) or small scale (1:1,000,000 is standard) maps may make terrain map association difficult. In these situations, the use of position locating systems or other navigational aids is essential for observer self-location and the accurate location of targets. See TC 3-25.26 for additional information on maps.

## TERMS AND RELATIONSHIPS

3-16. The following terms and relationships are provided to assist the observer in preparing to determine direction:

### Azimuth

3-17. Azimuth is a horizontal angle measured clockwise from a north base line that could be true north, magnetic north, or grid north. (ATP 3-09.50). An azimuth may be measured in degrees or mils between a reference direction and the line to an observed or designated point but, if possible, should be converted to mils (multiply the number of degrees by 17.8 to determine mils) before transmitting a call for fire. If the observer is not able to convert degrees to mils, the observer should state that the direction is given in degrees.

3-18. Measure a grid azimuth from grid north, measure a magnetic azimuth from magnetic north, and measure true azimuth from true north. The azimuth is the most common military method to express direction. When using an azimuth, the point from which the azimuth originates is the center of an imaginary circle. This circle is divided into 6400 mils or 360 degrees. See TC 3-25.26 for additional information. When sending call for fire (CFF) requests, observers will always send grid direction.

## Units of Measurement

3-19. Measure direction in mils (preferred) or degrees.

### Mils

3-20. A *mil* is a unit of measure for angles that is based on the angle subtended by 1/6400 of the circumference of a circle (TC 3-09.81). The mil is used because of its accuracy and the mil relation formula, which is based on the assumption that an angle of one mil will subtend an arc of one meter at a distance of 1,000 meters. The graphic representation of mil is a lower case letter "m" with a virgule (/) through it (m̄).

3-21. The mil relation formula (see figure 3-1 on page 3-4) has several applications in observed fire procedures. It can be used to determine the width of a lateral shift in meters to the nearest 10 meters from a known point to a new target. Use the mil relation in estimating distances based on known equipment dimensions in meters and measured mils and in determining deviation corrections in adjustment of fire procedures based on the deviation spotting in mils and the observer target distance factor (OT factor).

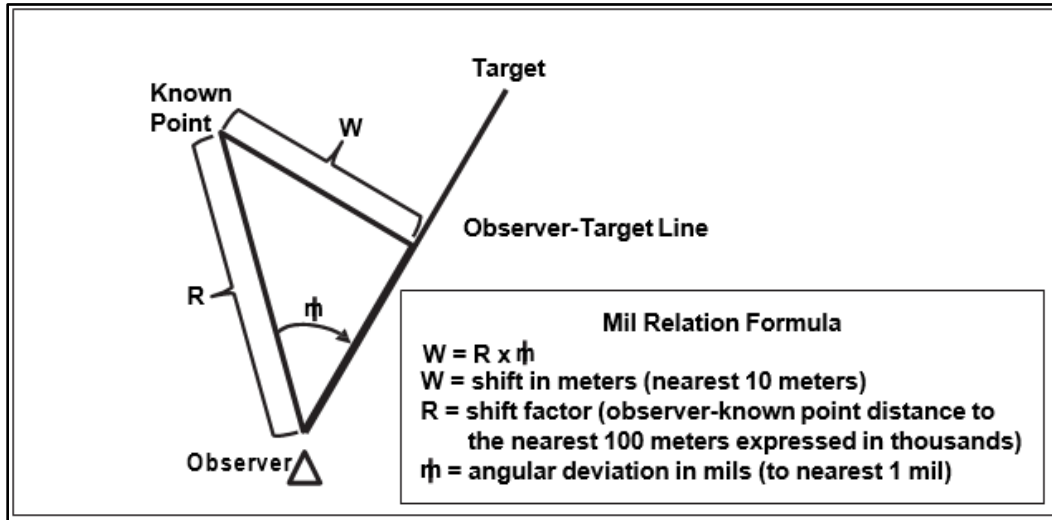

Figure 3-1. Example of mil relation formula in shift from known point

**Degrees**

3-22. A degree is a unit of horizontal clockwise angular measurement that is equal to 1/360 of a circle. Degrees may be converted to mils by multiplying the number of degrees by approximately 17.8 (mils = number of degrees X 6,400 ÷ 360).

**Cardinal Directions**

3-23. Cardinal directions are expressed in terms of north (N), northeast (NE), east (E), southeast (SE), south (S), southwest (SW), west (W), and northwest (NW). Figure 3-2 illustrates the relationship between cardinal directions, mils, and degrees.

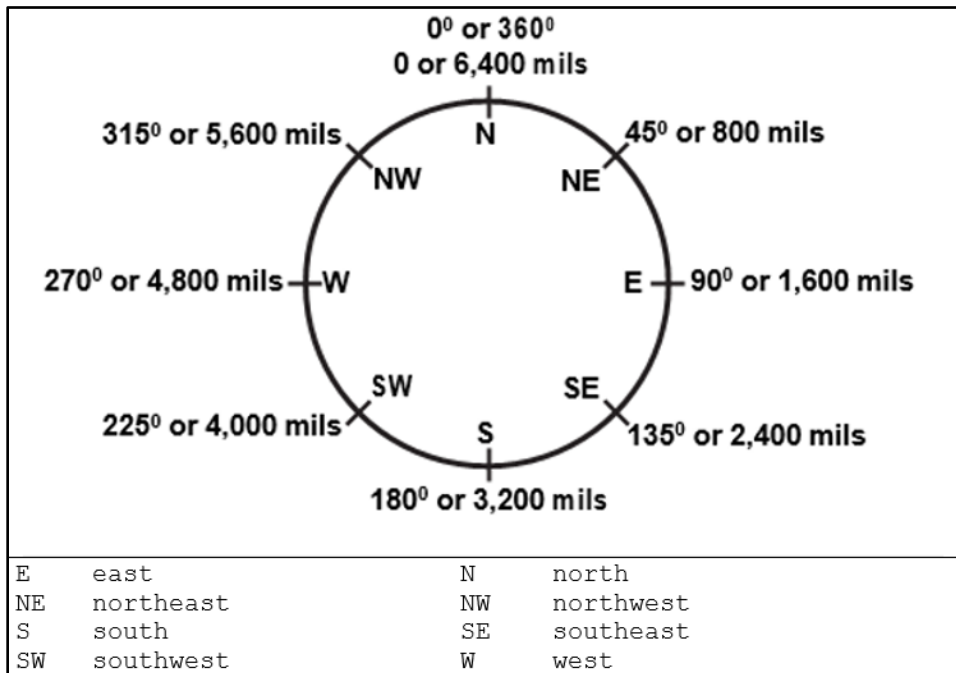

Figure 3-2. Cardinal directions

### Right Add, Left Subtract Rule

3-24. Compute the direction to a target by determining the difference (horizontal angular deviation) in mils between a reference point of known direction and the target, then adding or subtracting the measured difference to the known direction. Direction increases to the right and decreases to the left. Therefore, to determine the direction to the target, apply the number of mils measured right or left of the reference point known direction by use of the right add, left subtract (also called RALS) rule. For example, the azimuth to the reference point is 2,100 mils. The target is 40 mils to the left of the reference point. The direction to the target is 2,060 mils (2,100 - 40). If the target is 60 mils to the right of the reference point, the direction to the target is 2,160 mils (2,100 + 60).

### Observer-Target Line

3-25. The *observer-target line* is an imaginary straight line from the observer to the target. It is the most commonly used direction for locating targets and conducting adjustments.

### Observer-Target Factor

3-26. The *observer-target factor* is the distance in meters from the observer to the target expressed to the nearest thousand and in thousands. See chapter 5 for a detailed discussion of how to determine the OT factor for distances greater than and less than 1,000 meters.

### Gun-Target Line

3-27. The *gun-target line* is an imaginary straight line from gun to target (JP 3-09.3).

### Angle T

3-28. *Angle T* is the interior angle formed at the target by the intersection of the observer-target and the gun-target lines with its vertex at the target (TC 3-09.81). If angle T is 500 mils or greater, the FDC should tell the observer. If the observer is told that angle T is 500 mils or greater, at first the observer continues to use the original OT factor to make deviation corrections. If the observer is getting more of a correction than asked for, the observer should consider cutting the corrections to better adjust rounds onto the target. Announced angle T is expressed to the nearest 100 mils. For example, if angle T is 580 mils express and announce angle T as **Angle T 600** (see figure 3-3 on page 3-6).

## METHODS TO DETERMINE DIRECTION

3-29. There are five methods used to determine direction. They are—using automated measuring devices, measuring from a reference point, using a compass, scaling from a map (also use of automated imagery), and estimating.

### Using Precision Measuring Devices

3-30. When properly calibrated, the laser designator and rangefinder, aiming circle, and other measuring devices can provide direction to the nearest mil.

### Measuring Form a Reference Point

3-31. Using a reference point with known direction, the observer can measure horizontal angular deviations and apply them to the reference direction. Measure angular deviations with laser range finder, binoculars, or with the hand. If measuring with binoculars, angular deviation is determined to the nearest one mil.

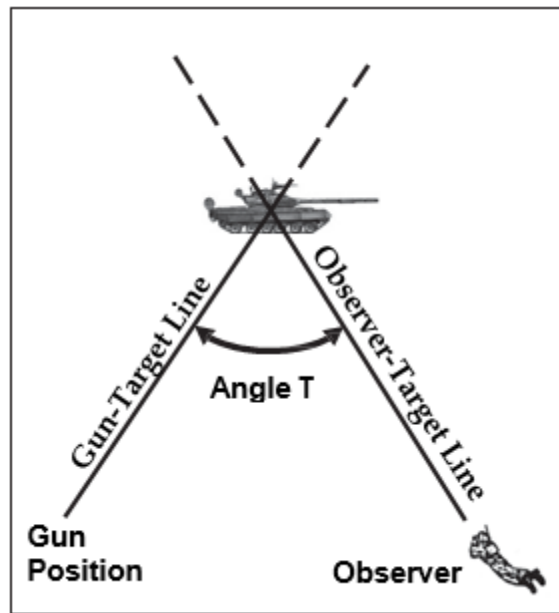

Figure 3-3. Angle T

### *Reticle Patterns*

3-32. Figure 3-4 shows the horizontal and vertical scales of the M22 or M24 binocular reticle pattern divided into increments of 10 mils with shorter hash marks at 5 mil increments. Use the vertical scale in height of burst (HOB) adjustment. The scale cannot be used to determine vertical angle. Only a leveled measuring device can accurately measure vertical angle.

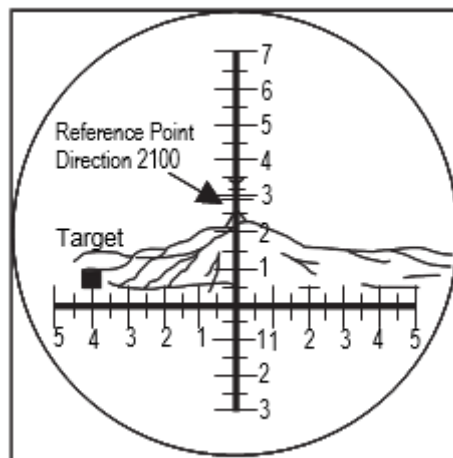

Figure 3-4. M22 and M24 binocular reticle pattern

### *Hand Measurement of Angular Deviation*

3-33. When all other means to measure angular deviation are not available, the observer may use the hand and fingers as a measuring device. Figure 3-5 (on page 3-7) shows approximate numbers for an average hand.

3-34. Each observer should calibrate ones hand and fingers to determine the width in mils for the various combinations of finger and hand positions shown, since finger and hand width vary for each observer. Calibrate hand measurements by comparing measurements taken with the hand and measurements taken with a more accurate measuring device.

3-35. When using hand and fingers in measuring angular deviation, the observer should fully extend the arm (elbow locked) so that the hand and fingers are always the same distance from the eyes. The observer always points the palm of the hand toward the target area and holds the fingers as demonstrated in figure 3-5 on page 3-7. Anything that changes the method, such as wearing a glove or not keeping the fingers together, will affect the measurement.

3-36. Hand measurement is a field expedient method for measuring angular deviation. Use methods that are more accurate than hand measurement when available.

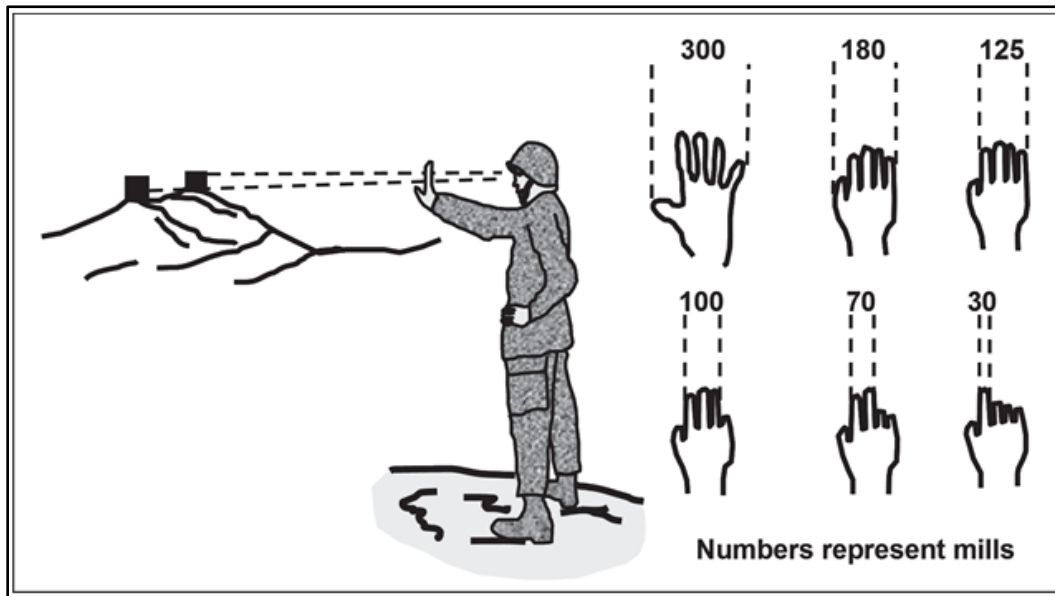

**Figure 3-5. Example hand measurement of angular deviation**

*Note.* The observer should memorize the width (in mils) of the fingers their hand, in Figure 3-5 are examples, and will vary depending on the size of an individual's hand. Then, when shifts of 100 mils or more are required, the observer can use the hand instead of binoculars for determining shifts to place fires on the adjusting point as quickly as possible.

### Using a Compass

3-37. Using a declinated M2 or a lensatic compass on a tripod or other stable platform, the observer can measure direction to an accuracy of 10 mils. Take care when using a compass around electronic devices such as radios and computers, or large concentrations of metal such as vehicles. Observers should move about 50 meters away from vehicles to avoid incorrect readings. Observers will always convert magnetic direction to grid direction for the CFF request unless otherwise stated.

### Scaling From a Map

3-38. Using a protractor, the observer can scale direction from a map to an accuracy of 10 mils. Observers may also use automated imagery to determine direction.

## Estimating

3-39. With a thorough terrain map analysis of the observers' area of operations, the observer can estimate direction on the ground. As a minimum, the observer should be able to visualize the eight cardinal directions (N, NE, E, SE, S, SW, W, and NW). Because of the inaccuracy of this method, it is the least preferred method of determining direction.

## DISTANCE

3-40. Once a direction to the target is determined, the observer must determine a distance to the target. Distance is the horizontal space between a reference point or an observer and a target (observer-target distance). The meter is the standard unit of measurement for distance. There are several methods to determine distance.

## LASER

3-41. Laser range finders are the preferred means of determining the observer-target distance. When a laser range finder is used, distance may be determined to the nearest 10 meters.

## FLASH TO BANG

3-42. When it is necessary to verify observer-target distance, the flash to bang technique is helpful. Sound travels at a speed of approximately 350 meters per second. Use the following equation:

- Elapsed time (seconds) between visible impact and sound arrival x 350 meters per second = distance (meters).
- Count the number of seconds between the time the round impacts (flash) and the time the sound reaches the observer (bang) and multiply by 350 meters per second. The answer is the approximate number of meters between the observer and the round. (The observer can also use this procedure to determine the distance to muzzle flashes from threat weapons.)

### Example

The observer wants to determine the approximate distance from own position to a burst. The observer begins counting when the burst appears and stops when the sound is heard. The observer counts 4 seconds. Therefore, the distance from the burst to the observers' position is approximately 1,400 meters (350 x 4).

## ESTIMATION

3-43. In the absence of a more accurate method of determining distance to a target, the observer must estimate distance. The degree of accuracy in this method depends on several factors, such as terrain relief, time available, and the experience of the observer. Generally, the longer the observer remains stationary, the better this technique can be used.

## Mental Estimation

3-44. Use of a known unit of measurement to make a mental estimate of distance. Estimate distance to the nearest 100 meters by determining the number of known units of measure, such as a football field (100 yards), between the observer's position and a target. For longer distances, the observer may have to estimate distance progressively. To do this, the observer determines the number of units of measure (100 yards) to an intermediate point and doubles the value. The observer should consider the effects in table 3-1 when estimating distance.



**Table 3-1. Considerations in mental estimation of distance**

<i>Conditions Where Objects Appear Nearer</i>	<i>Conditions Where Objects Appear More Distant</i>
In bright light.	In poor light or fog.
In clear air at high altitude.	When only a small part of the object is visible.
Looking down from a height.	Looking over a depression, most of which is visible.
Looking over a depression, most of which is hidden.	When the background is similar in color to the object.
Looking down a straight feature, such as a road.	When observing from a kneeling or sitting position on a hot day, when the ground is moist.
Looking over water, snow, or a uniform surface such as a cultivated field.	
When the background is in contrast with the color of the object.	

**Estimating When Visibility is Good**

3-45. When visibility is good, estimate distances by using the appearance of tree trunks, their branches, and foliage (using the naked eye) in comparison with map data (see table 3-2).

**Table 3-2. Estimation by appearance of trees**

<i>Distance (meters)</i>	<i>Tree Description</i>
1,000	Trunk and main branches are visible. Foliage appears in cluster like shape. Daylight may be seen through foliage.
2,000	Trunk is visible, main branches are distinguishable, and foliage appears as smooth surface. Outline of foliage of separate trees is distinguishable.
3,000	Lower half of trunk is visible. Branches blend with foliage. Foliage blends with adjoining trees.
4,000	Trunk and branches blend with foliage. Foliage appears as a continuous cluster. Foliage motion caused by wind cannot be detected.
5,000 and beyond	Whole area covered by trees appears smooth and dark.

**Estimating by Using Known Dimensions**

3-46. Distances can be estimated by using known dimensions of vehicles and the mil relation formula ( $R=W \div m$ ). By using the width of a vehicle appearing perpendicular to an observer as the lateral distance (W) and measuring the width in mils (m), the distance can be determined by solving the formula for range (R) in thousands, or  $R = W \div m$ . This data, when compared with map data, will help an observer estimate distance. Observers should prepare quick reference tables of the dimensions of common pieces of threat equipment found in the operational area. Table 3-3 on page 3-10 provides the dimensions of selected equipment.

Table 3-3. Equipment dimensions

<i>Equipment</i>	<i>Dimensions (meters)</i>	
	<i>Side View</i>	<i>Front View</i>
Tank (T-54/55) (hull)	6.0	3.3
Tank (T-62) (hull)	6.6	3.3
Tank (T-72B-1) (hull)	7.0	3.6
Tank (T-80) (hull)	7.4	3.4
Tank (T-90) (hull)	6.9	3.4
Reconnaissance vehicle (BRDM-2)	5.8	2.4
Armored personnel carrier (BTR-80)	7.6	2.9
Armored personnel carrier (BMP-1/-2)	6.7/6.7	2.9/2.4
Air Defense Weapon (ZSU-23-4)	6.5	3.0
<b>Note.</b> Prior to deployment, determine the dimension information on common opponent equipment, which may also include Vehicles from several different nations.		

### Example

An observer sees a T-55 tank, and measures its width (as seen from the side view) as 2 mils. Using the formula  $R + W \div r$  the observer determines the distance as:  
 $r = 2$  mils  
 $W = 6.0$  mils  
 $R = 6.0 \div 2 = 3.0$  or 3000 meters

### Estimating From a Terrain Study

3-47. The observer should always use terrain map analysis to help estimate distance. A thorough study of the terrain in comparison with features or objects identifiable on the map can enhance the estimation of distance. The observer should make a mental terrain walk to the target. Then compares the features or objects with those found on the map along the same direction (observer-target line). The use of an observed fire (OF) fan (see below) will help the observer in this. Give particular emphasis to color contrasts along the observer-target line. For example, the distance across successive ridgelines or depressions in the distance may be identifiable to the eye by only slight changes in color.

### OBSERVED FIRE FAN

3-48. The OF fan, graphic training aid 6-7-3 (see figure 3-6) is a transparent protractor that helps the observer identify on the map the terrain as seen on the ground. The OF fan has 17 radial arms that are 100 mils apart and cover 1,600 mils. Arcs marked on the radial arms every 500 meters starting at 1,000 and extending to 6,000 meters represent the observer-target distance. Once the observer has determined an observer-target direction, the observer can use the OF fan to help determine an observer-target distance on the map.

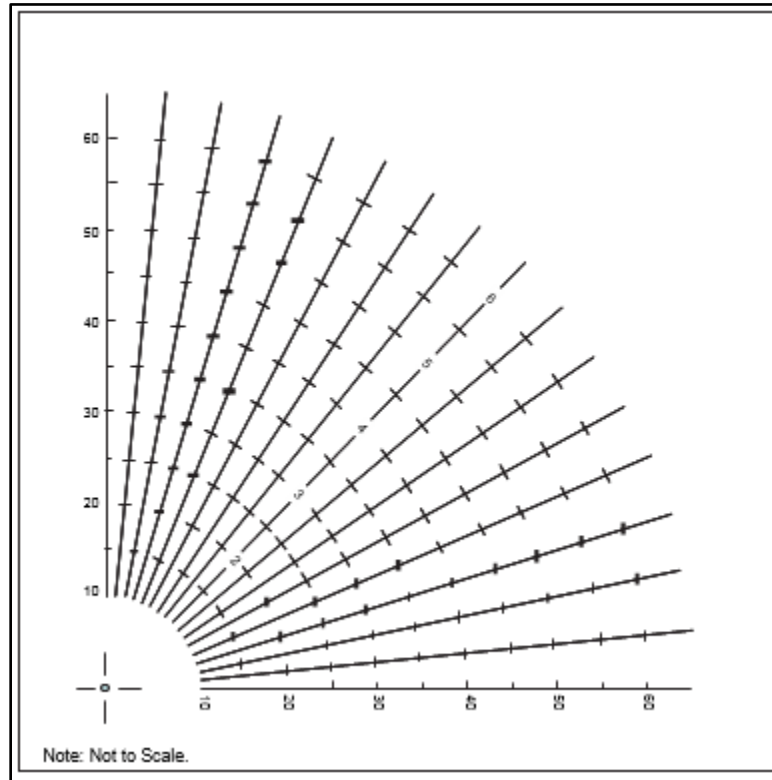

**Figure 3-6. Observed fire fan (1:50,000) (graphic training aid 6-7-3)**

### Preparation

3-49. The scale of the OF fan must match the scale of the map. To prepare the OF fan-

- Place the vertex (crosshair) of the fan exactly over the observer's location.
- Place the center radial in the direction of the center of the observer's area of responsibility.
- Move the fan slightly until one of the radial lines is parallel to a grid line. The direction of that radial line is the same cardinal direction as the grid line. For example, a radial line parallel to an east west grid line, with the OF fan oriented generally east, would be direction 1600.

---

*Note.* The observed fire fan does not have to be oriented at a right angle. Any radial line can be parallel with a grid line.

---

- With a non-water based map pen, number the radial of known direction. Drop the last two zeros (1600 would be 16). Then label every other radial line with the appropriate direction.
- 

*Note.* Radial lines are 100 mils apart.

---

### Use

3-50. To use the observed fire fan-

- Look at the terrain the target occupies.
- Determine the direction to the target using the most accurate means available.
- Estimate the distance to the target by analyzing the terrain.

- Set off the direction on the OF fan. Plot the observer-target direction on the OF fan by finding the two radial lines between which the observer-target direction falls and visually interpolating the determined direction.
- Set off the estimated distance to the target. Look out along this interpolated radial line at the estimated observer-target distance. This is the estimated target location.
- Use terrain association to refine distance. Compare the terrain near the target with the terrain of the estimated target location on the map. If they do not agree, search along the radial line until the terrain and the map match.
- Determine target location. Determining a grid location for the target is a natural extension knowing the determined observer-target direction and the refined distance. The observer plots the observer-target direction and distance to the target on the OF fan and reads the corresponding grid from the map. As an example in figure 3-7, the observer has determined that the target is at direction 0700 at a distance of 3,300 meters. The corresponding grid location on the map is 535268. The observer can further determine the target grid elevation by using the map contour intervals.

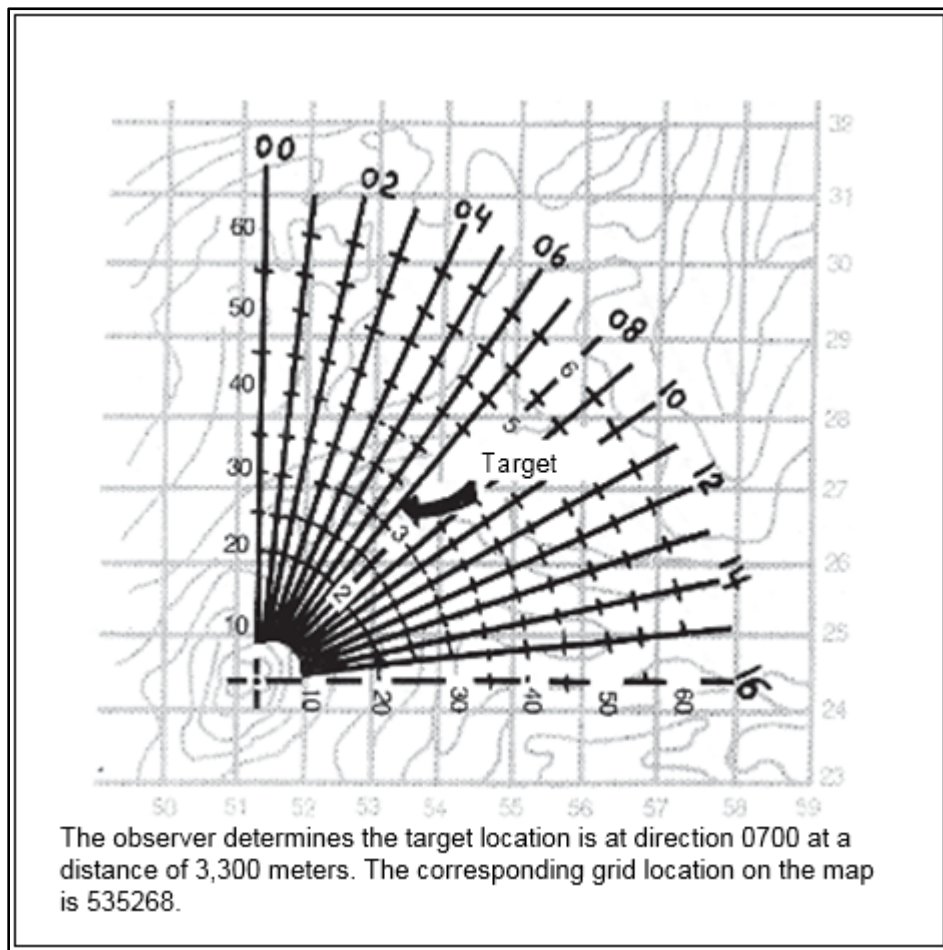

Figure 3-7. Target location using the OF fan

## ALTITUDE

3-51. **Altitude** is the vertical distance of a level, a point or an object considered as a point, measured from mean sea level or height above ellipsoid. Methods of measuring altitude include: imagery with a mensuration tool, map spot, vertical shift, and vertical angle. The meter is the standard unit of measurement for altitude using mensuration, map spot and vertical shift methods. Regardless of which method the observer uses, the observer must send the altitude of the target in the CFF. The standard for vertical angle measurement is mils. Some munition requirements vary between the use of Mean Sea Level (MSL) or Height Above Ellipsoid (HAE) for altitude. See ATP 3-09.32 for more detail.

The usage of the terms “Altitude” and “Elevation” are used throughout this ATP with very similar meanings. However when conducting CAS operations the term “Elevation” is expressed in regards to a point affixed to the ground, and “Altitude” refers to in the air off of the ground (for example, operating altitude). When conducting Surface to Surface fires the usage of these terms are different.

## PRECISION IMAGERY WITH MENSURATION

3-52. Using imagery with a mensuration tool yields the most accurate altitude for target location.

## MAP SPOT

3-53. If measured from a map, determine the altitude of a target by use of contour lines and the contour interval of the map.

## VERTICAL SHIFT

3-54. Altitude may also be determined as a vertical shift from the altitude of the observer's position (or from a known point) to the target. If there is a significant difference in vertical shift (greater than or equal to 35 meters in altitude between the observer's position or a known point and the target), the observer includes the vertical shift in the target location (expressed to the nearest 5 meters). If the target is at a **higher** altitude than the observer (or known point) the observer determines an **UP** correction based on the difference in altitude (see figure 3-8). If the target is at a **lower** altitude, the observer must give a **DOWN** correction based on the difference in altitude.

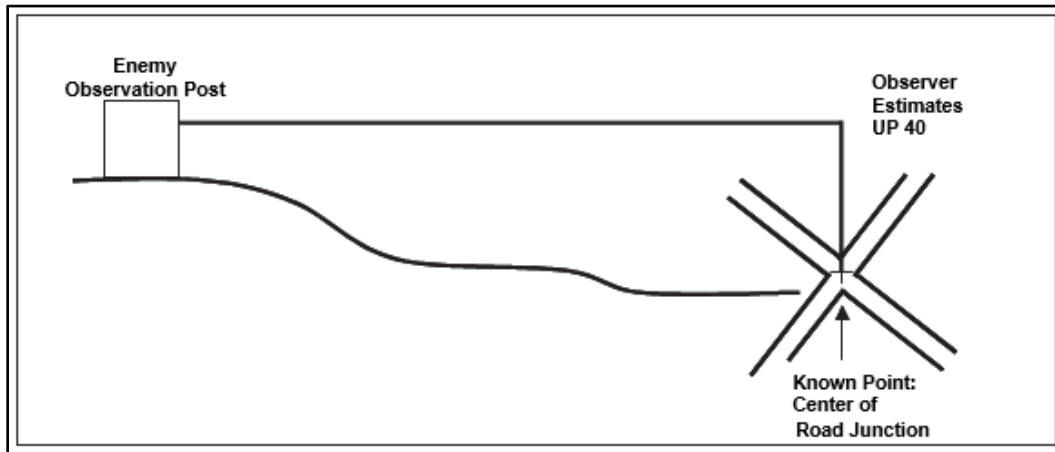

Figure 3-8. Vertical shift

3-55. Normally, if the mission is a fire for effect mission, send a vertical shift to improve accuracy. The observer should weigh the time needed to determine and send a vertical shift against the time available. Experienced observers who can quickly determine differences in altitude should send a vertical shift when the difference in altitude is greater than or equal to 35 meters and express it to the nearest 5 meters. When responsiveness is paramount, inexperienced observers should not try to send a vertical shift.

## VERTICAL ANGLE

3-56. A *vertical angle* is the angle measured vertically, up or down, from a horizontal plane of reference and expressed in plus or minus in mils depending on whether the position is above or below the horizontal plane (TC 3-09.81). The vertical angle is normally expressed as a plus or minus depending on whether the line from the observer to the target is above (plus) or below (minus) the observer's horizontal plane (see figure 3-9). Vertical angle (versus shift) is determined in laser polar missions with a leveled measuring laser designator and rangefinder.

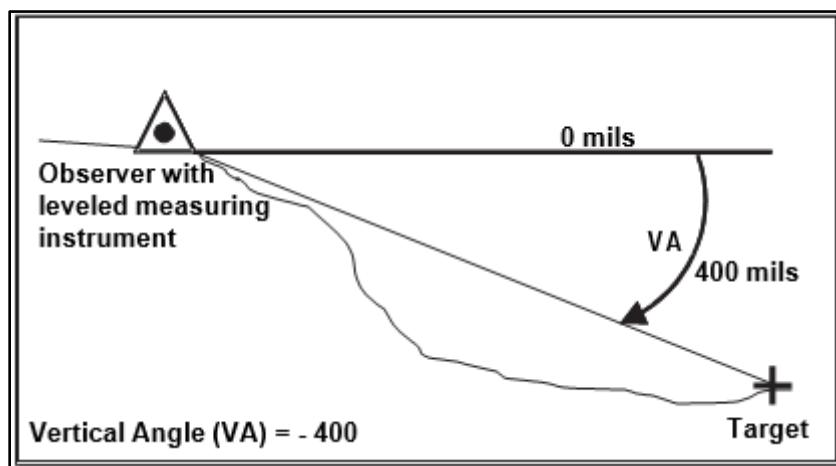

Figure 3-9. Vertical angle

## TERRAIN SKETCH

3-57. The terrain sketch is a panoramic sketch as accurate as possible of the terrain by the observer of the area of responsibility. It aids in target location in a static environment. The terrain sketch should include the following:

- The skyline (horizon).
- Intermediate crests, hills, and ridges.
- Other natural terrain features (distinctive bodies of water and vegetation).
- Manmade features (buildings, roads, power lines, towers, antennas, and battlefield debris).
- Labels (reference points and targets).

3-58. Each labeled item should include as much information as possible to aid the observer. Use a "T" format (see figure 3-10) to identify information. Place reference point names, target numbers, or known point (kn pt) designations at the top of the T to identify the feature. Place labels for direction (dir), distance (dis), altitude (alt), and grid on the left side of the T. The observer should fill in all available data for targets and known points. Reference points usually require only the direction to the reference point. Data should be determined to the left edge of the reference point, unless the target has been fired upon; then use the target center of mass. The terrain sketch should also include the observer's name, time, date, and location.

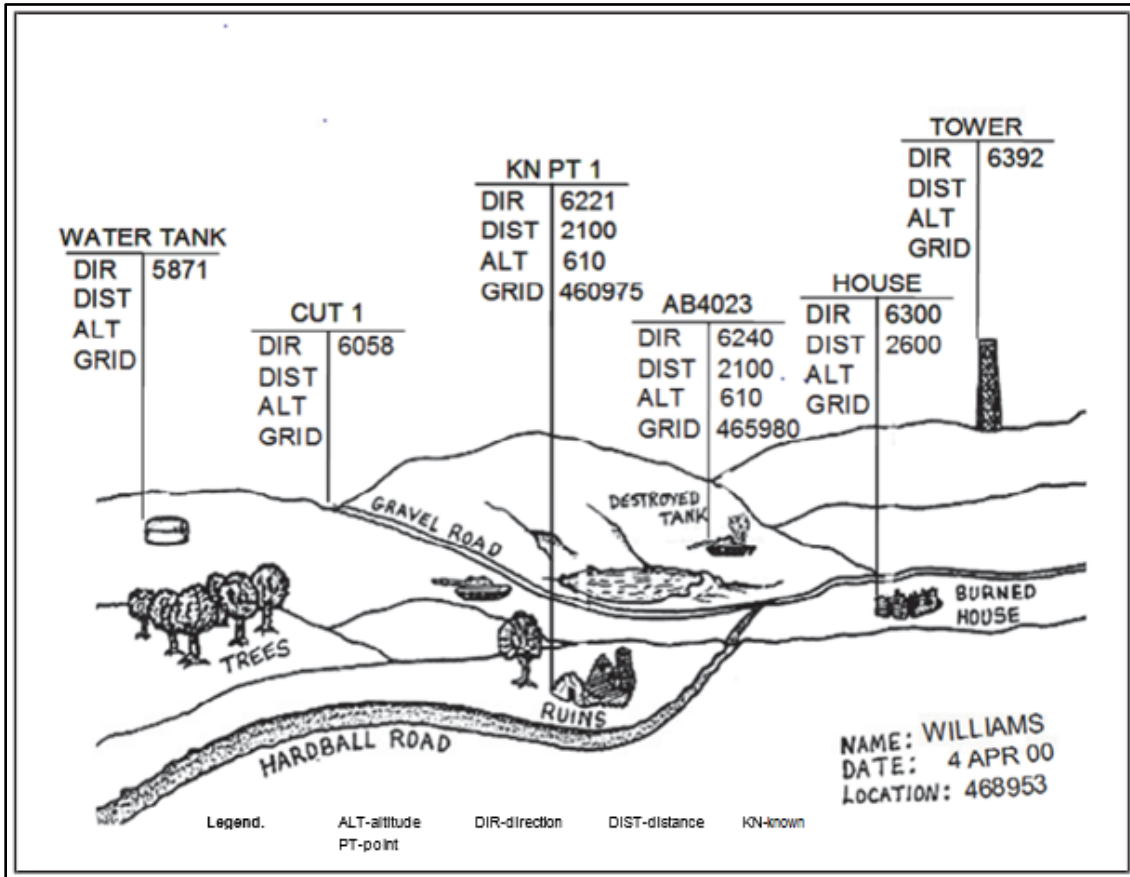

Figure 3-10. Example terrain sketch

3-59. Once it is constructed, the observer can use the terrain sketch to help quickly and accurately locate targets by referencing from information already known in the area of responsibility. A terrain sketch also provides a rapid means of orienting relief personnel. Terrain sketches must be continually refined and updated with data from available fire support planning documents, to include target numbers, the FPF, and any FSCMs.

## METHODS OF TARGET LOCATION

3-60. In order to perform these target location methods, the observer must possess some fundamental skills to include determining direction, distance, grid, vertical shift, and vertical angle. The goal of accurate target location is to achieve first round fire for effect. Mensuration methods are the most preferred and accurate way of developing target location. The methods of target location are listed in order of preference:

- Grid coordinates using precision imagery with mensuration tools.
- Laser grid.
- Laser polar.
- Grid coordinates using map spot.
- Polar plot.
- Shift from a known point.

## GRID COORDINATES USING IMAGERY WITH MENSURATION TOOLS

3-61. Grid coordinates using imagery with mensuration tools is the most preferred method of target location. Mensuration involves using a software package that is loaded with imagery used to refine targets. Mensuration tools have images that can be used to determine the grid and altitude of a location with increased accuracy. This accuracy supports the use of precision-guided munitions.

### LASER GRID

3-62. There are two types of laser targeting devices. An automated targeting device will provide a TLE along with a 10 digit grid to include altitude and is capable of accurately locating a target. This accuracy supports the use of precision-guided munitions. When mensuration is not available, grid coordinates provided by an automated laser system will support the use of precision-guided munitions. An automated laser system that is operating in a degraded mode should be considered the same as a conventional laser.

3-63. A conventional laser will not provide a TLE. It does provide a greater level of accuracy than grid coordinates developed by map spot. An observer should use this method if automated targeting tools are unavailable.

3-64. A laser grid mission is the same as a grid mission with the following exceptions: Send target grid to a greater level of accuracy (8 or 10 digit grid depending on observation post location accuracy). In an adjust fire mission, send corrections in the form of a grid to the burst location and announce “**BURST GRID**”.

### LASER POLAR

3-65. In the laser polar method, the FDC must know the observer's location. The observer uses a lasing device that has been oriented for direction to provide a quick and accurate means of target location. If the firing unit has met its requirements for accurate fire, the mission type for laser polar should be fire for effect. The observer determines observer-target direction to the nearest one mil, distance to the target to the nearest 10 meters, and vertical angle (not vertical shift) to the nearest one mil. The FDC determines target location using the vertical angle and incorporating distance as a slant range. The accuracy of the target location is dependent upon the accuracy of the laser location.

## GRID COORDINATES USING MAP SPOT

3-66. When more accurate means are unavailable, the observer must use a map and declinated M2 compass to develop target grid coordinates. Target location by grid coordinates is a natural extension of the polar plot method. The FDC does not need the observer's location. The observer normally locates targets to a precision of 100 meters (6 digit grid). The observer does this by polar plotting on the appropriate map and then reading the grid and altitude. When greater accuracy is required (for precision-guided munitions, registration points, and known points) the observer should send target locations, at a minimum, to the nearest 10 meters (8 digit grid) to include altitude.

---

*Note.* A six digit grid is normally submitted when the observer is not able to generate a coordinate accurate enough for first round fire for effect and should be sent as an Adjust Fire mission.

---

### POLAR PLOT

3-67. In this method, the FDC must know the observer's location. The observer does not need a map to determine polar plot data. The method is easy and quick. However, the observer must transmit own location by secure means to avoid revealing observation post (OP) location to the threat. In addition, in a mobile situation it may be more difficult for the observer to determine self-location and send it to the FDC resulting in a lower level of accuracy. The steps used in the polar plot method (see figure 3-11) are:

- Determine the observer-target direction by one of the methods previously discussed in this chapter.
- Estimate the distance to the target to the nearest 100 meters. (Laser rangefinder data can be determined to the nearest 10 meters.) Use all information obtained from the terrain map study to determine the observer-target distance.



- Determine a vertical shift, if significant. Determine an up or down shift if the difference between the observer altitude and the target altitude is significant (greater than or equal to 35 meters and expressed to the nearest 5 meters).

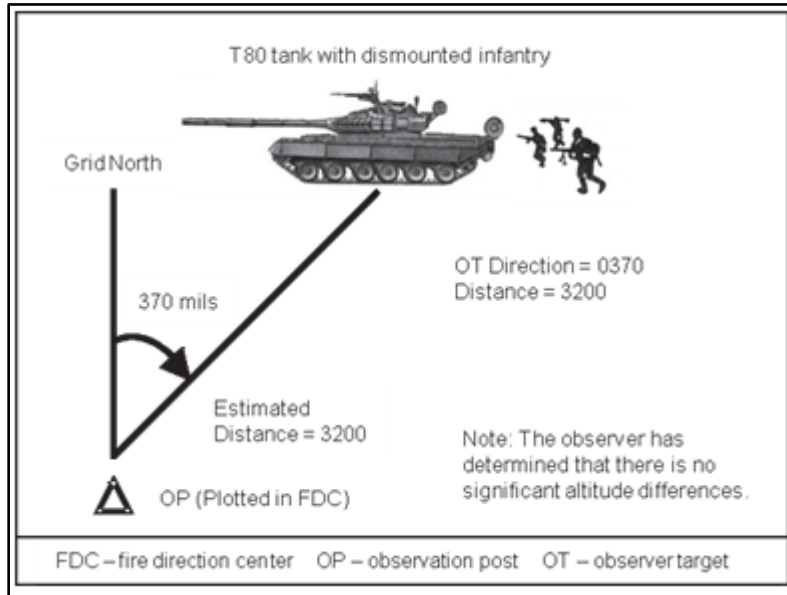

Figure 3-11. Polar plot

**SHIFT FROM KNOWN POINT**

3-68. This is the least preferred and most difficult method of target location. The observer may have one or more known points in the area of responsibility. These are readily identifiable points whose locations are both known by the observer and the FDC. The observer does not need a map to use this method; only needs a known point. The steps in locating a target by shift from a known point are:

- Identify the known point used to the FDC, for example, **SHIFT KNOWN POINT 1**.
- Determine the observer-target direction. This direction can be a grid azimuth expressed to the nearest 10 mils (the preferred method) or a cardinal direction. Examples are (grid azimuth) **DIRECTION 4360** and (cardinal direction) **DIRECTION, SOUTHWEST**.
- Determine a lateral shift from the known point in meters to the new target. By determining the angular deviation from the observer-known point line to the observer-target line, a shift in meters can be determined by using the mil relation formula,  $W = R \times m/$  (see example in figure 3-12 on page 3-18).

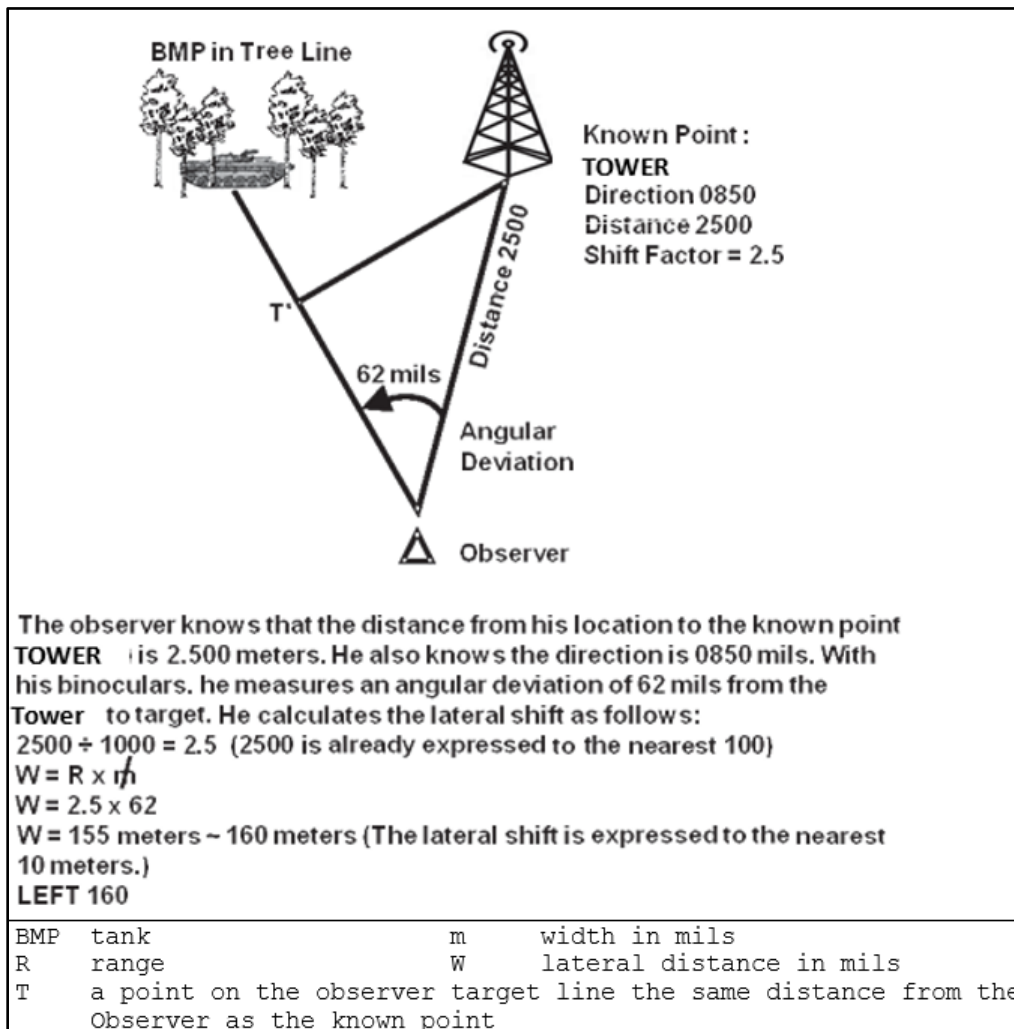
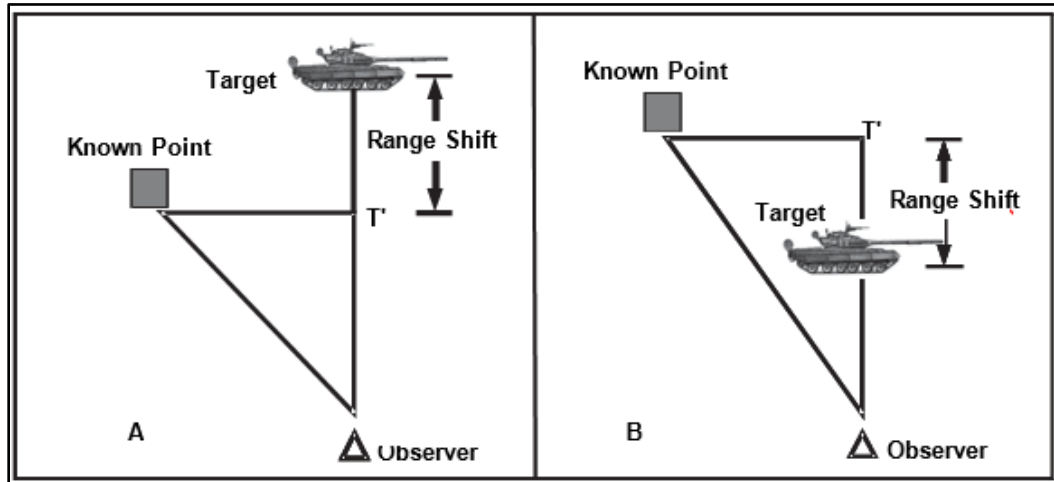

Figure 3-12. Lateral shift

*Note.* When shift of greater than 600 mils is required, the accuracy of computing the lateral shift decreases. Use another method of target location.

3-69. Determine a range change to the new target in relation to the known point. The observer must determine whether the target is at a greater or lesser distance than the known point. The lateral shift gives the observer a point on the observer-target line (T') assumed to be the same distance from the observer as the known point. If the target is **farther away** than the known point, the observer must **add** the estimated distance from T' to the target (see figure 3-13 A on page 3-19). If the target is **closer** than the known point, the observer must **drop** the estimated distance (see figure 3-13 B on page 3-19). Express the correction for a difference in distance between the known point and the target to the nearest 100 meters.



**Figure 3-13. Range shift**

3-70. Determine the vertical shift. If the difference in elevation between the known point and the target is greater than or equal to 35 meters, the observer includes an **UP** or **DOWN** shift (expressed to the nearest 5 meters) in the target location.

## TARGET LOCATION ERROR

3-71. Accurate target location is critical for precision-guided munitions and these munitions are most effective when using a mensurated target location. Table 3-4 provides recommended TLE's for weapon and target pairing to create the commander's desired effect on the target. Accurate target location also benefits area munitions by potentially reducing the number of rounds fired in adjustment. TLE should not be used as a restrictive measure, but as a factor of engagement criteria. Commanders should always weigh mission success against expenditure of munitions. Refer to table 3-4 on page 3-20.

3-72. Given the importance of accurate TLE for the effective employment of precision-guided munitions, if the sensor allows it, observers will report their achieved TLE (based on their sensor type, forward observer system version, and observer-target range) when requesting a precision-guided munition. Transmit this information as part of the call for fire in the target location portion of the call for fire request. If it is not included, the FDC will prompt the observer to provide the achieved TLE for this mission. The following tables and paragraphs explain TLE and current sensor systems associated with each TLE method. The TLE methodology table (see table 3-4 on page 3-20) is intended as a guideline and is not inclusive of all systems available. There are several combinations of ways to use these pieces of equipment but for optimal effects on target an Observer or FIST should use an automated targeting device to acquire the target and transmit the information to the forward observer digital system, then refine the target with the mensuration tool, populate the other parts of the CFF on the forward observer digital system and then digitally send the CFF to the next higher echelon in the fires chain. Figure 3-14 (on page 3-20) lists the TLE categories.

**Table 3-4. Targeting Device Methodology for Artillery and Mortars**

Target Location Error	Target	Munition	Targeting Device
CAT I	Structures, dug in targets	XM395 APMI M982A1 Excalibur M31 GMLRS(U)	Mensuration (PFED with PFI, PSS SOF) Precision Laser (LLDR IIIH)
CAT II	Surface, Mobile Targets	XM395 APMI M982A1 Excalibur M31 GMLRS(U)	Mensuration (PFED with PFI, PSS SOF) Precision Laser (LLDR IIIH)
CAT III	Surface, Mobile Targets	HE with PGK	Mensuration (PFED with PFI, PSS SOF) Precision Laser (LLDR IIIH)
CAT IV and above	Surface, Mobile Targets	Ballistic Munitions	Map spot with compass Conventional Lasers (Mark VII E, LLDR, Vector21, FS3)

**Legend**  
 HE High Explosive  
 APMI Accelerated Precision Mortar Initiative  
 GMLRS Guided multiple launch rocket system  
 PGK Precision Guidance Kit  
 PSS SOF Precision Strike Suite Special Operations Force  
 PFED pocket-sized forward entry device  
 PFI Precision Fires Imagery  
 LLDR Laser Locator Designator Rangefinder  
 CAT Category

TLE Categories (reference circular error on ground)	CAT I CE 0-20 ft 0-6 m			CAT II CE 21-50 ft 7-15 m			CAT III CE 51-100 ft 16-30 m			CAT IV CE 101-300 ft 31-91 m			CAT V CE 301-1000 ft 92-305 m			CAT VI CE >1000 ft (>305m) or Large Elliptical Error		
Circular, Vertical, Spherical Error Predictions	CE 90	VE 90	SE 90	CE 90	VE 90	SE 90	CE 90	VE 90	SE 90	CE 90	VE 90	SE 90	CE 90	VE 90	SE 90	CE 90	VE 90	SE 90

**Legend**  
 CAT category      ft feet      SE spherical error      VE vertical error  
 CE circular error      m meter      TLE target location error

**Figure 3-14. TLE Categories**

**TECHNIQUES FOR REFINING TLE**

3-73. The commander may determine a need for a more accurate target location from the observer before firing on a target. Techniques to reduce the TLE include target coordinate mensuration, cuing a more accurate sensor, and triangulation.

## TARGET COORDINATE MENSURATION

3-74. Use target coordinate mensuration to reduce TLE significantly. Correlating the expected target location through the use of National Geospatial Agency (NGA) validated TCM tools, processes, and imagery produces a precise aimpoint that can be used to engage the target.

3-75. During the target coordinate mensuration process, the derived target location is identified on a tactical image such as full motion video or another image source. The Target Mensuration Only (TMO) operator then identifies the target location on Digital Point Precision Data Base (DPPDB) imagery and derives the true target location. In cases where PFI is used, the PFI is generated from DPPDB using an NGA validated PFI generator. An imagery chip is created and saved to a removable memory card and installed into a PFI viewer. Most PFI's have restrictions on their use with certain systems. See the NGA validation statement for the PFI restrictions associated with the applicable TCM tools.

3-76. Imagery used during TCM is classified; ensure source imagery classification is maintained when generating PFI's and coordinated. TCM tools allow users to derive highly accurate target locations NGA validated imagery. If the observer has TCM tools, has created the required PFIs for the area of operations and is TMO certified, the observer can perform TMO. During dynamic situations such as hostile act or hostile intent, non-certified observers may use the best means available to derive a coordinate. If a TCM tool is used by a non-certified TMO operator this is not considered TCM. Certain handheld observer devices also provide the ability to send digital call for fire missions with mensurated target coordinates also displaying the TLE associated with the derived coordinate.

3-77. If the observer cannot conduct TMO, the observer will request target coordinate mensuration with the request for fires and provide additional target location information. Typically, the fires cell at the battalion command post has the capability to conduct TMO, and usually has access to better working conditions, and more imagery data. This allows the fires cell to conduct TMO for a much wider area (so long as the imagery data is available) than the observer. Once the fires cell has conducted TMO on the target, they can submit it as a fire request or add it to a planned target list for future engagement.

### Cue a More Accurate Sensor

3-78. There may be another observer in the target area that possesses a more accurate sensor and can provide a better TLE. The FDC can request that another sensor or observer with more accurate TLE locate the target. Process this request through the fires cell. The FSO could then task another observer with a more accurate sensor to move to a position to observe the target. Additionally, there may be aircraft or UAS assets equipped with sensor systems in the target area that can generate accurate coordinates. The FSO working with the JTAC may employ these systems mission, enemy, terrain, and weather, troops, and support available, time available, and civil considerations permitting.

### Triangulation

3-79. Triangulation is another possible means to provide reduced target location error, although it is time consuming and therefore is limited to situations not requiring immediate responsiveness. Perform triangulation using one or more sensors. The more sensors used, the greater the accuracy. When more than one observer or sensor is available, multiple sensors locate the target and provide target coordinates to the FDC. The FDC then resolves these multiple sets of coordinates to determine a more accurate target location. If only one sensor or observer is available, then they must obtain target data from a minimum of two different locations at least 100 meters apart. The farther the observer moves between readings, and the more locations from which readings are taken, the more accurate the resulting target location will be.

## TECHNIQUES FOR LASING BUILDINGS

3-80. Ground observers must use special procedures in lasing buildings to determine an accurate target location. Ground observers are generally only capable of lasing the sides of the building, yet the actual desired impact location for a munition may be in the center of the building's roof because of the munitions' steep terminal trajectory and top attack characteristics.

3-81. In instances where the observer is in a position to see the top of the building (observer is located in an adjacent building, on elevated terrain) the observer will lase the top of the building at the desired impact location for the round, using the standard call for fire.

3-82. Engaging buildings can best be achieved using target coordinate mensuration to refine target grids. In instances where the observer is not in a position to lase the top of the building, and does not have the ability to conduct target coordinate mensuration, can employ the following steps:

- Lase one of the sides of the building as close as possible to and along the azimuth to the desired impact location of the round.
- The observer will determine distance and direction to the structure. The observer will then estimate the distance from the lase point to the center of the structure. The observer will then add the distance from own location to the lase point and then add an estimated distance from the lase point to the center of the building to obtain an estimated distance to the building's center grid.

---

*Note.* Observer must carefully consider their position in relation to the target. The observer facing west would subtract the estimated distance in meters from the easting. The observer facing east would add the estimated distance in meters to the easting. The observer facing north would add the estimated distance in meters to the northing. The observer facing south would subtract the estimated distance in meters from the northing.

---

- Observers must be aware that some targets may result in multiple returns. Testing has determined that concrete walls resulted in multiple returns back to the sight (degraded TLE). A technique to consider for reducing laser degradation is setting the laser to last return, and firing multiple lases at the same aim point and selecting the most common return. Hard shiny targets with greater reflectivity result in better returns.

---

*Note.* If for any reason the observer has to power down the laser, upon power up the observer should lase several targets as a means to improve the laser shot accuracy. The observer should also perform calibration of the laser to reduce TLE and increase system confidence.

---

- The observer will initiate a polar plot call for fire or adjust the grid, then call for fire with the FDC using the determined direction and the estimated distance obtained for the structure's center grid.

## CAS EMPLOYMENT TARGET “TALK-ON”

3-83. Once the target information and attack parameters have been established, and the CAS aircraft are able to see into the target area for direct fire or bomb on target attacks, the JFO or JTAC and CAS aircrew are ready for the target “talk-on.” The purpose of a “talk-on” is to correlate the targeting information passed (that is, CAS 9-line brief with remarks, map plot confirmation, and enhanced target description) to the intended target for the CAS aircrew while considering the CAS asset's visual sensor perspective for direct fire engagement. The JTAC or FAC (A) must be confident that the CAS asset has acquired the intended target before allowing weapons release during type 1 controls. Tactics and techniques to accomplish the “talk-on” are dependent on the battlefield situation, the perspective of the JFO, JTAC, FAC (A), CAS aircrew, and targeting systems available to each. As the JFO and JTAC teams consider the CAS asset's perspective, they should also consider whether to use large target area features cueing to smaller features or to use more narrowly focused initial search patterns to expedite target correlation with aircraft targeting sensors. Talk-on TTPs are also driven by communications capabilities, availability of sensors (ground observer and aircraft), video downlink capability, aircraft navigation systems, grid and urban reference guides, and operational imagery graphics available to all participants in the joint fires chain.

3-84. The JFO and JTAC or FAC (A) must maintain continuous communication with the attacking aircraft. Normally, the JTAC will conduct the target “talk-on” based on the targeting information from the JFO; however the JTAC may authorize the JFO to pass targeting information directly to the CAS aircrew for the “talk-on”. If the JFO is not able to communicate directly with the aircrew, communications will be facilitated by the JTAC. First, establish a common reference point on the ground.

3-85. This point serves as the starting point for the “talk-on” and should be easily identifiable from the air and from the observer location. Selection of this common reference point is dependent on aircraft and ground party sensor capabilities.

- If precision targeting systems are unavailable, then the starting point would be a feature of the target’s surroundings, which based on perspective, is identifiable to both the JFO and CAS aircrew. From this feature a gradually more detailed description would begin, ultimately resulting in proper correlation to the intended target.
- Should precision targeting tools be available, the JFO and JTAC team with the CAS aircrew may be able to generate relatively accurate and precise target coordinates with elevation due to improvements in portable tactical targeting systems and CAS aircraft sensor suites. Leveraging these, the JTAC and JFO may elect to conduct a narrowly focused initial “talk-on” technique. The terminal controller can use the coordinate and elevation from the JFO as an “anchor point” from which the CAS aircrew and JFO-JTAC team will look around the target area in order to positively acquire the CAS target(s).

3-86. Next, establish a unit of measure that can be seen on the map or aircrew targeting sensor, as well as on the ground from both the JFO and CAS aircrew perspective. The unit of measure is a distance “yardstick” used to move the aircrew’s eyes though the target area. Once established, a rule of thumb is to not use less than one quarter of that unit of measure or more than 4 units of measure during a “talk-on”, if possible.

3-87. In conjunction with the unit of measure, cardinal and sub-cardinal directions are used to move the aircrew’s eyes from the starting point to smaller reference points and finally onto the intended target. The art of moving the aircrew’s eyes from one point to another on the battlefield should be deliberate and simple, and it can be significantly aided by modern sensors and targeting systems.

3-88. Target verification is the process of ensuring that CAS aircrews are “tally” (which means that the pilot has confirmed eyes on the target from the aircraft) the intended target during the “talk-on”. For CAS types 2 and 3 controls, it is conducted with the aircrew talking to the JTAC thru the JFO.

---

**NOTE:** Target verification can be very time intensive since it entails a three-way communication. During the target verification process, time can be saved when the JFO can communicate directly with the aircrew, while the JTAC monitors transmissions. This TTP emergency CAS requires the JFO to have communications equipment compatible with the aircraft, and it works especially well with FAC (A) qualified aircrew, but should not be limited to them exclusively.

---

## COMBAT IDENTIFICATION OF A TARGET

3-89. *Combat identification* is the process of attaining an accurate characterization of detected objects in the operational environment sufficient to support an engagement decision (JP 3-09). (See ADRP 3-37 for more information.) The combat identification process has the following three key purposes:

- Identify and classify targets in the operational environment.
- Allow for the timely processing of engagement decisions on targets.
- The mitigation of fratricide and collateral damage.

3-90. The combat identification process is a series of progressive and interdependent steps (or actions): target search, detection, location, and identification that lead to the decision process to engage or not engage. Soldiers conduct combat identification by applying situational awareness and target identification capabilities and by adhering to OPODs with all appendices and annexes, and approved ROE that directly support the Soldier’s engagement decision.

3-91. Combat identification standardizes the approach in deciding the appropriate level of force against all types of targets. It consists of:

- **Detection.** The discovery of any phenomena (personnel, equipment, objects) that are potential targets. Soldiers can use detection from various means (visual observation, radar detection, electronic signals measurement).
- **Location.** The determination (by direction, reference point, or grid) of where a potential target is located (ground or air).

- **Identification.** The determination of the friendly, hostile, unknown, or neutral character of a detected, potential target by its physical traits (size, shape, functional characteristics).
- **Classification.** The categorization of a potential target by relative level of danger it represents.
- **Confirmation.** The rapid verification of a target in terms of the initial identification and classification. Soldiers confirm identification as a threat before engaging. When engagement is considered, Soldiers answer the following questions:
  - Can I engage the target based on ROE?
  - What are the second and third order effects if I engage the target?
  - Which target should I engage first (if there are multiple targets)?
  - What is the best weapon system to use? (use the attack guidance matrix)
  - Is the target planned or a target of opportunity?
  - Is the target on the High Payoff Target List?

## POSITIVE IDENTIFICATION OF A TARGET

3-92. Positive identification is reasonable certainty that the entity or object is a valid military target and the correct target. The entity or target must demonstrate a hostile act, intent, or be on the approved list of targets. Failure to gain positive identification (also called PID) on the target can result in fratricide or unnecessary collateral damage. Additionally, failure to positively identify factors such as civilians and noncombatants on the battlefield will negatively impact mission results and create unintended 2<sup>nd</sup> and 3<sup>rd</sup> order effects for the maneuver commander and other U.S. Army units.

### Example

The observer sees a vehicle traveling down a road. Visibility is poor but can identify the vehicle is a tank. Situational understanding indicates no friendly tanks are in the area. If the observer was told to engage any military vehicles traveling on the road, the observer can engage the tank according to the ROE. If the guidance is to engage only those vehicles positively identified as adversary, the observer would be required to verify the tank was an adversary vehicle prior to engaging.

### Example

The observer is part of a team observing a building believed to contain a high-payoff target. The guidance for the mission included a requirement to positively identify the target prior to attacking. The observer identifies the suspect target, verifies the target is dressed as described by an informant, and visually confirms the targets facial features match those of the high-payoff target. Additionally, ongoing intercepts indicate the target is currently using a cell phone, which the observer can visually verify. The observer can engage this target with reasonable certainty that this is the high-payoff target.



## Chapter 4

# Call For Fire

The Army developed the call for fire format in order to simplify the process of relaying the information from the observer to the firing unit. The call for fire format is designed to handle the majority of missions. However, special circumstances may require a more detailed discussion between the observer and the firing unit.

### DESCRIPTION

4-1. A *call for fire* is a request for fire containing data necessary for obtaining the required fire on a target (FM 3-09).

4-2. A call for fire is a concise message prepared by the observer. It contains all of the information needed by the fire direction center (FDC) to determine the method of target attack. It is a request for fire, not an order.

4-3. The observer transmits the call for fire digitally or by voice. The key factor is deciding which method will best provide immediate responsive and accurate fires in every circumstance. Another important factor is the inability of all interested parties to monitor the digital traffic. Digital communications are the primary means of transmitting the CFF, voice should be used only when digital systems are unavailable or when the intensity of the conflict precludes the use of digital systems. In a digital call for fire, the elements of the call for fire are the same as for a voice call for fire.

4-4. CFF routing procedures (who sends which message to what fires cell or FDC) must be established and trained in accordance with the degree of control the supported commander wishes to exert. In situations where responsiveness is the critical consideration of the fire support system, the observer should route the digital call for fire directly to the lowest level FDC possible (mortar or artillery) as long as it has been cleared through the proper channels. Coordinating fires cells receive the call for fire via message of interest processing from the respective FDC and accomplish any coordination or approval required while the mission is processed at the delivery unit. In situations requiring close control of fire support assets or when massing of fires is the primary fire support considerations, the observer should route the digital call for fire through the controlling fires cell to the controlling FDC. Generally, digital calls for fire are used in the following situations:

- Normal (non-immediate) fire for effect or adjust fire missions.
- Fires on planned targets (data can be preloaded into the digital device). For example, during a movement to contact the FIST prepares the message to fire the next priority target after passing and canceling the last one.
- Registrations.

4-5. Voice calls for fire are used when-

- Digital communications have been lost between the observer and the FDC or fires cell. The unit standing operating procedure (SOP) or the tactical situation will dictate the number of attempts made to digitally reach the subscriber before trying voice.
- Immediate suppression or immediate smoke is required and the mission has not been preloaded into the digital device.
- Requesting fires on planned targets and the data has not been preloaded into the digital device.
- The intensity of the conflict prevents use of digital systems.
- Receiving calls for fire from untrained observers.

4-6. Send the voice call for fire quickly but clearly enough that it can be understood, recorded, and read back, without error, by the FDC recorder. The observer should tell the radio operator that a target has been identified so the radio operator can start the call for fire while the target location is being determined.

4-7. The observer uses the Department of the Army (DA) Form 5429 (Conduct of Fire) in conducting fire missions and recording mission data. Use section I to record the call for fire and subsequent adjustment data. Use section II to record registration data.

## SIX ELEMENTS OF THE CALL FOR FIRE

4-8. The six elements of a call for fire include: observer identification, warning order, target location, target description, method of engagement and method of fire and control. Regardless of the method of target location used, the call for fire is normally sent in three transmissions, consisting of six elements, with a break and read back after each transmission. Send the information for each transmission as it is determined, rather than waiting until a complete call for fire has been prepared. The transmissions and elements are organized in the following sequence: See Figure 4-1 on page 4-4, GTA 17-02-015 Call for Fire and/or Figure 4-2 on page 4-9, GTA 06-07-005 Observed Fire Reference Card.

- Observer identification and warning order.
- Target location.
- Target description, method of engagement, and method of fire and control.

### OBSERVER IDENTIFICATION

4-9. This element tells the FDC who is calling for fire.

### WARNING ORDER

4-10. The warning order clears the net for the fire mission. The warning order consists of the type of mission, the size of the element to fire for effect, and the method of target location.

### TYPE OF MISSION

4-11. The warning order begins with one of the following mission types: adjust fire, fire for effect, suppress, immediate suppression or immediate smoke.

#### Adjust Fire

4-12. When the observer believes the situation requires an adjusting round (because of questionable target location or lack of registration corrections), the observer announces **ADJUST FIRE**.

#### Fire for Effect

4-13. The observer should always strive for first round fire for effect. The accuracy required to fire for effect depends on the accuracy of target location and the ammunition chosen. When the observer is certain that the target location is accurate and that the first volley should have the desired effect on the target so that little or no adjustment is required, the observer announces **FIRE FOR EFFECT**.

#### Suppress

4-14. To quickly bring fire on a target that is not active, the observer announces **SUPPRESS** (followed by the target number). Normally, suppression missions are fired on planned targets, and a length of time to continue firing (duration) is associated with the call for fire.

#### Immediate Suppression or Immediate Smoke

4-15. When engaging a planned target or target of opportunity that has taken friendly maneuver or elements under fire, the observer announces **IMMEDIATE SUPPRESSION** or **IMMEDIATE SMOKE** (followed by the target location). When conducting an immediate mission the CFF is sent in one transmission.

## SIZE OF ELEMENT TO FIRE FOR EFFECT

4-16. The observer may request the size of the unit to fire for effect, for example, **BATTALION**. Usually this is done by announcing the last letter in the battalion FDC's call sign. For example, T6H24 is announced **HOTEL**. The observer should never refer to a battery or other unit in the clear; but should refer to it by call sign. Secure communication devices allow units to use plain language call signs. Use the plain language call sign in such a case to designate the unit to fire for effect. For example, Alpha Battery's call sign is Thunder.

4-17. Although the observer may request a size of element to fire for effect, the fire direction center will make the ultimate decision based on the attack guidance received, Joint Munitions Effectiveness Manuals Weaponizing System (JWS) solution, and the rules of engagement that are in effect.

## METHOD OF TARGET LOCATION

4-18. Methods of target location include grid, laser grid, polar plot, laser polar, and shift from a known point. When utilizing precision targeting devices, it is required to transmit target location error (TLE) in the target location portion of the call for fire request.

### Grid

4-19. The observer sends the most accurate target location possible. The minimum acceptable standard is a six digit grid when calling for fire on a map spotted target location. Send a minimum eight or ten digit grid location for registration points or other points for which greater accuracy is required. Altitude is included immediately after the grid. The observer-target direction is normally sent after the entire initial call for fire, since the FDC does not need the direction to locate the target.

4-20. Grid is the standard method of target location and when used is not announced in the warning order.

### Laser Grid

4-21. A laser grid mission is the same as a grid mission with the following exceptions:

- Send target grid to a greater level of precision (8 or 10 digit grid depending on observer or observation post location error).
- In an adjust fire mission, corrections are sent in the form of a grid to the burst location.

4-22. The observer announces **LASER GRID**, for example **FIRE FOR EFFECT, LASER GRID, OVER**. After the read back by the FDC, the forward observer announces the grid and altitude as normal, followed by the TLE if known. For example; **GRID ND1234567890, ALTITUDE 390 M HAE, TLE 2.9 OVER**.

---

*Note.* A mission is not a laser grid mission just because the observer used a laser to determine the initial target location. If the observer plans to send normal left, right, add, or drop corrections, the mission is a normal grid mission. The mission is a laser grid mission only when the method for subsequent corrections are laser burst corrections.

---

### Polar Plot

4-23. In a polar plot mission, the word polar in the warning order alerts the FDC that the target will be located with respect to the observer's position. The FDC must know the observer's location. The observer then sends the direction and distance. A vertical shift tells the FDC how far, in meters, the target is located above or below the observer's location. Vertical shift may also be described by a vertical angle in mils, relative to the observer's location.

4-24. The observer announces **POLAR**. For example, **ADJUST FIRE POLAR, OVER**.

### Laser Polar

4-25. Laser polar differs from a polar mission in that laser data is sent to the nearest one mil for direction (instead of the normal 10 mils) vertical angle and the nearest 10 meters for distance.

4-26. The observer announces **LASER POLAR**. For example, **ADJUST FIRE, LASER POLAR, OVER**.

### Shift from a Known Point

4-27. In a shift from a known point mission, (see figure 4-1) the target will be located in relation to a pre-existing known point or recorded target. In the warning order, identify the point or target from which to shift. (The observer and the FDC must know the location of the point or recorded target.) The observer then sends the observer-target direction. Normally, mils are the preferred unit of measure for a shift. However, the FDC can accept degrees or cardinal directions, whichever the observer specifies. The corrections are sent next:

- **Lateral shift** in meters (how far left or right the target is) from the known point.
- **Range shift** (how much farther [**ADD**] or close [**DROP**] the target is in relation to the known point, to the nearest 100 meters).
- **Vertical shift** (how much the altitude of the target is above [**UP**] or below [**DOWN**] the altitude of the known point, expressed to the nearest 5 meters). Vertical shift is usually only significant if it is greater than or equal to 35 meters.

4-28. The observer announces **SHIFT**, followed by the designation of the known point or by the target number. For example, **ADJUST FIRE, SHIFT KNOWN POINT 1, OVER**.

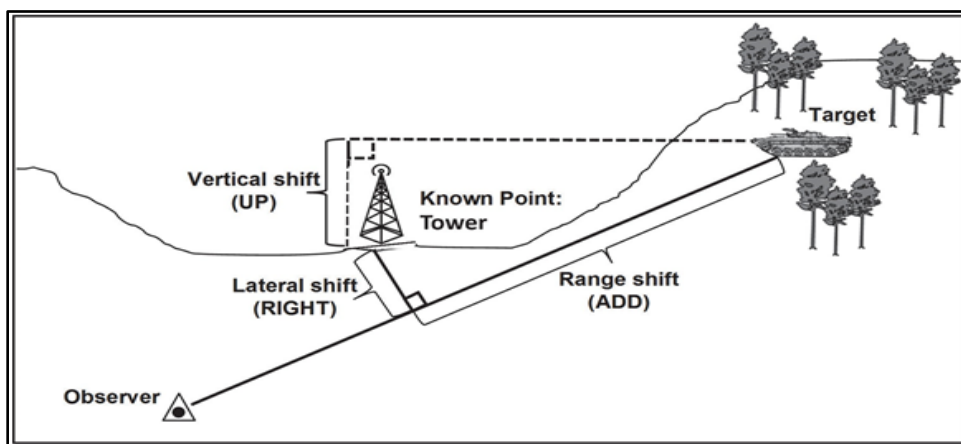

Figure 4-1. Shift from a known point

### TARGET DESCRIPTION

4-29. The observer must describe the target in enough detail that the FDC can determine the amount and type of ammunition to use. The FDC selects different ammunition for different types of targets. The observer should be brief but accurate. The description should contain the following:

- What the target is (troops, equipment, supply depot, trucks).
- What the target is doing (digging in, in an assembly area).
- The number of elements in the target (squad, platoon, three trucks, six tanks).
- The degree of protection (in the open, in foxholes, in bunkers with overhead protection).
- The target size and shape if these are significant. For a rectangular target, give the length and width (in meters) and the attitude. For example, **400 BY 300, ATTITUDE 2800**. For a circular target, give the radius. For example, **RADIUS 200**. For a linear target, give the length and attitude.

---

*Note.* In AFATDS the requirements for linear targets are the center grid, distance from center point, and attitude. It is the FDC's responsibility to ensure the data obtained from the observer is entered correctly.

---

## METHOD OF ENGAGEMENT

4-30. The observer may indicate how to attack the target. This element consists of the type of adjustment, trajectory, ammunition, and distribution. **DANGER CLOSE** and **MARK** are included as appropriate.

### Type of Adjustment

4-31. Two types of adjustment may be employed—area and precision. Unless precision is specified, area fire will be used.

#### *Area Fire*

4-32. Use area fire to attack an area target. Since many area targets are mobile, the adjustment should be as quick as possible, consistent with accuracy, to keep the target from escaping. A well-defined point at or near the center of the area to be attacked should be selected and used as an aiming point. This point is called the adjusting point during adjust fire missions. To achieve surprise, adjust fire on an auxiliary adjusting point, and after adjustment is completed, shift the fire for effect to the target. Normally, observers conduct adjustment on an area target with one adjusting weapon.

#### *Precision Fire*

4-33. Conduct precision fire with one weapon on a point target to obtain registration corrections or to destroy the target. When the mission is a registration, the FDC initiates it with a message to observer. If the intent is to destroy the target, the observer announces **DESTRUCTION**.

### Danger Close

4-34. **DANGER CLOSE** is included in the method of engagement when the target is (or rounds will impact) within 600 meters of any friendly troops for mortars and artillery, 750 meters for 5 inch naval guns and tomahawk land attack missile (also TLAM). **DANGER CLOSE** and risk estimate distances are different in meaning. Risk estimate distances can be referenced in ATP 3-09.32.

### Mark

4-35. **MARK** is included in the method of engagement to indicate that the observer is going to call for rounds for either of the following reasons:

- To orient self in the zone of observation.
- To indicate targets to ground troops, aircraft, or other observers.

### Trajectory

4-36. The trajectory is the path traced by the center of gravity of the projectile from the origin to the level point.

#### *Low Angle*

4-37. Standard without request.

#### *High Angle*

4-38. *High-angle fire* is the delivery of fire at elevations greater than the elevation of maximum range of the charge. Range decreases as the angle of elevation increases (TC 3-09.81). Mortars fire only high-angle. See chapter 7 for a more detail description of high-angle fire.

### Ammunition

4-39. The observer may request any type of ammunition during the adjustment or the fire for effect phase of his mission. Use a high explosive (HE) projectile with a mechanical time super quick (MTSQ) fuze for normal adjustment. If that is what the observer desires, it is not necessary to request it in the call for fire. If

the observer does not request a shell fuze, for the fire for effect phase, the fire direction officer determines the shell fuze combination. The unit SOP may designate a standard shell fuze combination.

4-40. If the observer desires a shell and fuze combination other than standard, the shell and fuze "in adjust" is announced first, then the shell and fuze "in effect". For fire for effect missions, it is not necessary to announce "in effect" after the shell and fuze request.

### *Followed By*

4-41. This is part of a term that indicates a change in the rate of fire, in the type of ammunition, or in another order for fire for effect. For example, if observer wants the ammunition white phosphorous (WP), then HE, the request is **WP FOLLOWED BY HE**.

### *Projectile*

4-42. An observer can request a specific munition, however, the FDC has the final determination based upon METT-TC. The following projectile types are available for request: HE-high explosive, hexachloroethane zinc, WP-white phosphorous, red phosphorous (RP) (mortars only), ILLUM-illumination dual purpose improved conventional munition (DPICM),-antipersonnel improved conventional munition, SMOKE, SCATMINE-scatterable mines, EXCALIBUR, precision guided munition, and guided multiple rocket launch system (GMLRS). EXCALIBUR, accelerated precision mortar initiative (APMI), and GMLRS are precision-guided munitions and are most effective when paired with mensurated coordinates.

### *Fuze*

4-43. Fuze quick is the fuze normally used during the adjustment phase. If the observer desires fuze quick or if a projectile that has only one fuze is requested, fuze is not indicated. Illumination, improved conventional munitions (ICM), and smoke projectiles are fuzed with time fuzes; therefore, when the observer requests ILLUMINATION, ICM, or SMOKE, the observer does not announce TIME. Fuze types are as follows: PD-point detonating, VT-variable time, MT-mechanical time, ET-electronic time, MTSQ- mechanical time super quick, DELAY, and MOF-multi option fuze (mortars only).

### *Volume of Fire*

4-44. The observer states the volume of fire desired in the fire for effect in rounds per howitzer. For example, 3 **ROUNDS**, indicates the observer desires the unit to fire three volleys in effect.

### **Distribution**

4-45. The observer may control the pattern of bursts in the target area. This pattern of bursts is called a sheaf. Unless otherwise requested, the artillery computer system assumes a circular target with a 100 meter radius. The artillery computer system determines individual weapon aiming points to distribute the bursts for best coverage of this type of target. **A converged sheaf is a special sheaf in which each piece fires a unique time, deflection, and quadrant elevation to cause the rounds to impact at the same point on the ground.** A converged sheaf is typically used for small, hard targets. **An open sheaf is a special sheaf in which each piece fires a unique time, deflection, and quadrant elevation to cause the rounds to impact in a straight line, perpendicular to the gun-target line and centered on the target, with bursts spaced one effective burst width apart.** Special sheaf (linear, rectangular, circular, or irregular) of any length and width may be requested. If target length, or length and width are given, the observer must also give attitude. If target length is greater than or equal to five times the target width, the artillery computer system assumes a linear target. The mortar ballistic computer assumes the target is linear and fires a parallel sheaf unless the observer requests a special sheaf. The parallel sheaf distributes the bursts of all pieces similar to the distribution of weapons on the gun line due to firing the same data with each piece.

## METHOD OF FIRE AND CONTROL

4-46. The method of fire and control element indicates the desired manner of attacking the target, whether the observer wants to control the time or delivery of fire, and whether the target can be observed. Methods of control at my command (AMC) and time on target (TOT) are especially useful in massing fires. The AMC and TOT missions achieve surprise and maximize the effects of the initial volley on a target. When used by the observer, these methods of control can reduce the sporadic engagement of the target, or "popcorn effect," which can be the result of rounds fired when ready.

### Method of Fire

4-47. In area fire, the observer normally conducts adjustment with one howitzer or with the center gun of a mortar platoon or section. If the observer determines that more than one gun is necessary for adjustment, the observer can request **2 GUNS IN ADJUST** or **PLATOON, BATTERY RIGHT (LEFT)**. (Adjusting at extreme distances may be easier with two guns firing.) The normal interval fired by a platoon or battery right (left) is 5 seconds. If the observer wants some other interval, it must be specified.

### Method of Control

4-48. Method of Control consists of fire when ready, at my command, cannot observe, time on target, time to target, coordinated illumination, continuous illumination, cease loading, check fire, continuous fire, repeat, do not load, and duration. This section below describes these methods further into detail.

#### *Fire When Ready*

4-49. This method is standard without request.

#### *At My Command*

4-50. If the observer wishes to control the time of delivery of fire, the observer includes **AT MY COMMAND** in the method of control. When the pieces are ready to fire, the FDC announces **PLATOON (or BATTERY, or BATTALION) IS READY, OVER**. (Call signs are used.) The observer announces **FIRE** when ready for the pieces to fire. This only applies to adjusting rounds and the first volley of a **fire for effect**. **AT MY COMMAND** remains in effect throughout the mission until the observer announces **CANCEL AT MY COMMAND, OVER**.

4-51. The observer can further specify at my command with additional instructions. **BY ROUND AT MY COMMAND** controls every round in adjustment and every volley in the fire for effect phase.

#### *Cannot Observe*

4-52. **CANNOT OBSERVE** indicates the observer cannot see the target (because of vegetation, terrain, weather, intensity of the conflict, or smoke).

#### *Time on Target*

4-53. The observer may tell the FDC when the rounds are to impact by requesting **TIME ON TARGET, 0859, OVER**. The observer must ensure that both the FDC and their time are synchronized prior to the mission.

#### *Time to Target*

4-54. The observer may tell the FDC when the rounds are to impact by requesting **TIME TO TARGET (so many) MINUTES AND SECONDS, OVER, STANDBY, HACK, OVER**. Time to target is the time the observer can expect rounds to hit the target. Express time to target in minutes and seconds after delivery of the "hack" statement.

### *Coordinated Illumination*

4-55. Coordinated illumination informs the FDC that the observer is going to attack targets with fires under the illumination. The idea is to have the HE rounds impact during the period of best illumination.

4-56. The observer can accomplish this by using normal **AT MY COMMAND** procedures, directing an interval, in seconds, between illumination and HE projectiles, or by identifying the period of best illumination and allowing the FDC to compute when to fire the HE. The command **ILLUMINATION MARK** is used to tell the FDC when the illumination round is providing the best visibility on the target.

### *Continuous Illumination*

4-57. In this method of control, the unit fires illumination projectiles at specified time intervals to provide uninterrupted lighting on the target or specified area. The observer may specify the time interval (in seconds). If the observer does not provide a time interval, the FDC determines the interval by the burning time of the illumination ammunition in use. If any other interval is required, indicate the desired interval in seconds.

### *Cease Loading*

4-58. Use the command **CEASE LOADING** during the firing of two or more rounds to indicate the suspension of loading rounds into the gun(s). The gun sections may fire any rounds that have already been loaded.

### *Check Fire*

4-59. Use **CHECK FIRING** to cause an immediate halt in firing. Use this command only when necessary to “immediately” stop firing (for example, for safety reasons) as it may result in cannons being out of action until any rammed or loaded rounds can be fired or cleared from the tubes.

### *Continuous Fire*

4-60. In field artillery, mortars, and naval surface fire support, continuous fire means loading and firing as rapidly as possible, consistent with accuracy, within the prescribed rate of fire for the equipment. Firing will continue until suspended by the command **CEASE LOADING** or **CHECK FIRING**.

### *Repeat*

4-61. **REPEAT** can be given during adjustment or fire for effect missions. During Adjustment, **REPEAT** means firing another round(s) with the last data and adjust for any change in ammunition if necessary. Do not send the command **REPEAT** in the initial call for fire.

4-62. During **fire for effect**, **REPEAT** means fire the same number of rounds using the same method of fire for effect as last fired. If the unit is firing four rounds in effect, requesting **REPEAT** will result in an additional four volleys. The observer may request changes in the number of guns, the previous corrections, the interval, or the ammunition. For example, **RIGHT 200 REPEAT**.

### *Request Splash*

4-63. Send **SPLASH** at the observer's request. The FDC announces **SPLASH** to the observer 5 seconds prior to round impact. The FDC must send **SPLASH** to aerial observers and during high angle fire missions

### *Do Not Load*

4-64. **DO NOT LOAD** allows the section to prepare ammunition and lay on the target without loading a projectile. When the command, **CANCEL DO NOT LOAD** is given the section automatically loads and fires the weapon (except for an at my command mission).

### *Duration*

4-65. The observer normally uses **DURATION** for suppression and smoke missions. **DURATION** will tell the FDC the total time to engage a target.



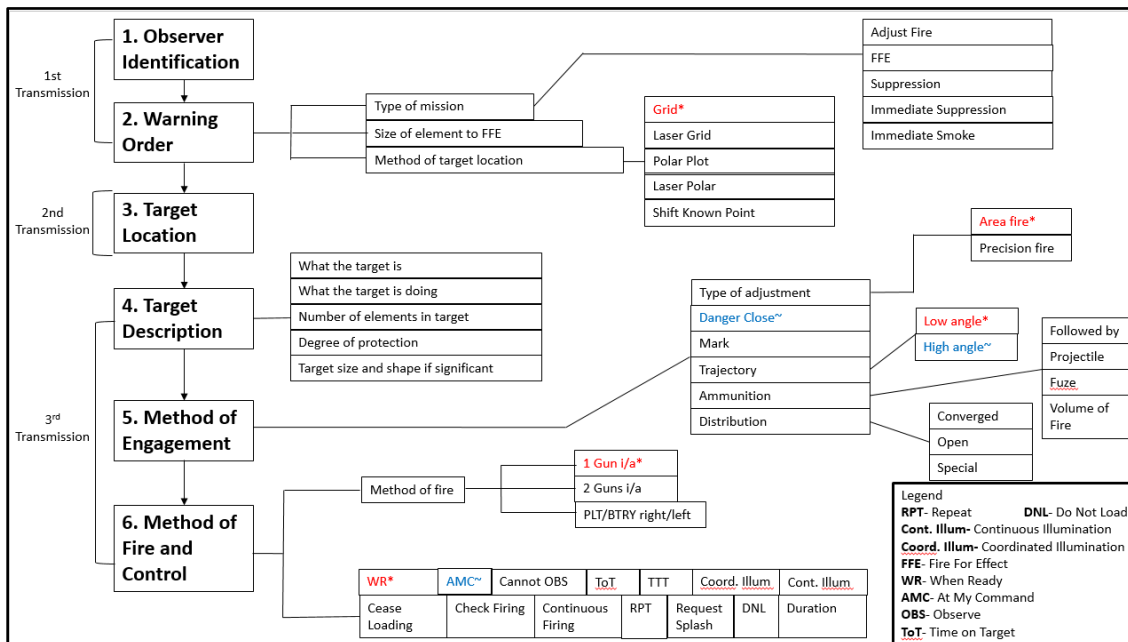

Figure 4-2 (Call For Fire flowchart)

## CORRECTION OF ERRORS

4-66. Observers or FDC personnel sometimes make errors in transmitting data or in reading back the data. If the observer realizes that an error has been made in the transmission or that the FDC has made an error in the read back, the observer announces CORRECTION and transmits the correct data.

### Example

Prior to the first correction the observer transmitted **DIRECTION 4680**. Observer immediately realizes that the direction should have been **DIRECTION 5680**. The observer announces **CORRECTION, DIRECTION 5680**. After receiving the correct read back, continue to send the rest of the call for fire.

4-67. When an error has been made in a sub element and the correction of that sub element will affect other transmitted data, **CORRECTION** is announced. Then transmit the correct sub element and all affected data in the proper sequence.

### Example

The observer transmitted **LEFT 200, ADD 400, UP 40, OVER**, then realizes that the correction should have been **DROP 400**. To correct this element, the observer sends **CORRECTION LEFT 200, DROP 400, UP 40, OVER**. The observer must read back the entire sub element, because the **LEFT 200** and **UP 40** will be canceled if they are not included in the corrected transmission.

## MESSAGE TO OBSERVER

4-68. After the FDC receives the call for fire, it determines if and how to attack the target. The FDC announces that decision to the observer in the form of a message to observer (MTO). The observer will acknowledge the MTO by reading back in entirety, and if conducting a grid mission may include, **BREAK**, **DIRECTION** (observer- target direction) at the end. The MTO consists of the four items discussed below.

### UNIT(S) TO FIRE

4-69. The battery (or batteries) that will fire the mission is (are) announced. If the battalion is firing in effect with one battery adjusting, the FDC designates the fire for effect unit (battalion) and the adjusting unit by using their specific call sign.

#### Example

The battalion call sign is Thunder. Battery A is Apache. Battery A will adjust, and battalion will fire for effect. The MTO would be **THUNDER, APACHE**.

### CHANGE TO CALL FOR FIRE

4-70. Announce any change to what the observer requested in the call for fire.

#### Example

The observer request ICM in effect and the fire direction officer decides to fire variable time (VT) fuze in effect. The MTO begins **T, G, VT IN EFFECT** or alternatively **THUNDER, APACHE, VT IN EFFECT**.

### NUMBER OF ROUNDS

4-71. Announce the number of rounds per tube in fire for effect.

---

*Note.* If the firing unit is MLRS and HIMARS the FDC will specify only the total number of rounds to be fired.

---

#### Example

The MTO thus far is **T, G, VT IN EFFECT, 4 ROUNDS** or alternatively **THUNDER, APACHE, VT IN EFFECT, 4 ROUNDS**.

### TARGET NUMBER

4-72. Assign a target number to each mission to facilitate processing of subsequent corrections.

**Example**

The MTO is **T, G, VT IN EFFECT, 4 ROUNDS, AA7732, OVER** or alternatively **THUNDER, APACHE, VT IN EFFECT, 4 ROUNDS, AA7732, OVER.**

**ADDITIONAL INFORMATION**

4-73. Transmit the additional information shown below separately or along with the MTO.

**PROBABLE ERROR IN RANGE**

4-74. If probable error in range ( $PE_R$ ) is 38 meters or greater during a normal mission, the FDC informs the observer. If  $PE_R$  is 25 meters or greater in a precision registration, the FDC informs the observer.

**ANGLE T**

4-75. Angle T is sent to the observer when it is 500 mils or greater or when requested.

**PULSE REPETITION FREQUENCY CODE**

4-76. A laser designator can emit laser pulses of different frequencies. The laser spotters on aircraft and some munitions can sense these frequencies. These frequencies are set as a three digit pulse repetition frequency code on the laser designator. For a laser designation mission to be successful, the observer and the weapon delivery system must use the same pulse repetition frequency code.

4-77. Pulse repetition frequency (also called PRF) codes are not entirely compatible across the spectrum of military laser equipment. Most Army designators and weapons use a three digit code, while the Air Force uses a four digit code. Upon receiving the three digit switch setting of the laser designator, a pilot converts it to the required four digits by inserting a one immediately before the three digits.

**TIME OF FLIGHT**

4-78. Send time of flight to an observer during a moving target mission, during an aerial observer mission, during a high angle mission, and for shell HE in a coordinated illumination mission when using **BY ROUND AT MY COMMAND**, or when requested.

**CAS REQUEST**

4-79. **Introduction to 9-Line CAS Brief.** JTACs, FAC (A) s, and JFO's will use a standardized briefing to pass information rapidly. The 9-Line CAS brief, also known as the "9-Line Briefing," is the standard for use with Fixed Wing and non-Army Rotary Wing aircraft. The CAS briefing form helps the aircrew to determine whether they have the information required to perform the mission. See figure 4-4 on page 4-14.

- (1) Line 1—Ingress Point (IP) or Battle Position (BP). The IP is the starting point for the run-in to the target. For rotary wing aircraft, the BP is where attacks on the target are commenced.
- (2) Line 2—Heading and Offset. The heading is given in degrees magnetic from the IP to the target or from the center of the BP to the target. The offset is the side of the IP to-target line on which aircrews can maneuver for the attack.
- (3) Line 3—Distance. The distance is given from the IP/BP to the target.
- (4) Line 4—Target Elevation. The target elevation is given in feet MSL unless otherwise specified.
- (5) Line 5—Target Description. The target description should be specific enough for the aircrew to recognize the target.
- (6) Line 6—Target Location. The JTAC, FAC (A), or JFO provides the target location.

- (7) Line 7—Mark Type and Terminal Guidance. The type of mark the JTAC, FAC (A), or JFO will use (for example, smoke, laser, or infrared [IR]). If using a laser, the JTAC, FAC (A), or JFO will also pass the call sign of the platform or individual that will provide terminal guidance for the weapon and laser code.
- (8) Line 8—Friendlies. Cardinal and sub-cardinal heading from the target (N, NE, E, SE, S, SW, W, or NW) and distance of closest friendlies from the target in meters (for example “South 300”).
- (9) Line 9—Egress. These are the instructions the aircrews use to exit the target area.
- (10) Remarks and Restrictions. Supplies additional information important to the conduct of the attack.

**4-80. JTAC to JFO Integration.** JTACs and FAC (A) s can use JFO’s to develop and correlate targeting data, mark targets, and provide terminal guidance operations. JFOs may pass the observer lineup, the CAS situation update and observer target brief directly to the JTAC or may require the CAS aircraft to relay the situation update to the JTAC (see figure 4-3 on page 4-13). In certain circumstances, the ground commander might require air support when a JTAC or FAC (A) is not available, but detailed integration with friendly forces and maneuver is still required. The commander must consider the increased risk of fratricide when using personnel who are not JTAC or FAC (A) qualified.

4-81. The information the JFO reports will paint a picture of the battlefield for the fires cell and maneuver commander. SALT or SALUTE reports should include targets, potential targets, and areas of interest identified in the observation plan as well as collateral damage concerns. Potential collateral damage concerns should be passed to the fires cell with cardinal sub-cardinal direction and distance in meters from targets and should include a description of the composition of the collateral damage concern (for example, a one story wooden trailer with a tin roof being used as a school, civilians in the open, or a concrete religious site). This information is critical for the commander to accurately assess the situation and associated risks to determine the proper course of action. JFO reporting information also forms the basis for the fires cell and TACP to create immediate CAS requests so it must include all relevant data from DD Form 1972 *Joint Tactical Air Strike Request* Section I (see ATP 3-09.32). Once the joint fires assets are coordinated, the JFO must be able to format the targeting data properly to facilitate fires and desired effects. JFOs must also be aware of their own targeting capabilities and limitations such as target location error, range and line of sight to the target, obstructions and obscurations, equipment capabilities, and equipment operation proficiency among others. When fires impact but fail to produce proper effects, the JFO must provide adjustments and corrections to ensure the maneuver commander’s desired effects are created. The JFO must assess the effects of those fires on the intended target and other effects on the battlefield, such as resultant enemy and noncombatant activity or collateral damage.

<b>JOINT FIRES OBSERVER TARGET BRIEF</b>	
2. Target elevation:	
3. Target description:	
4. Target location: (latitude and longitude or grid coordinates or offsets or visual)	
5. Type mark / terminal guidance: (description of the matrix, if laser handoff, call sign of lasing platform, and laser code)	
6. Location of friendlies: (from target, cardinal location, and distance in meters)	
Position marked by:	
"ADVISE WHEN READY FOR REMARKS"	
Remarks and restrictions:	
Final attack heading:	
Laser target line (LTL) or pointer target line (PTL):	
Threat: (direction and distance)	
Suppression of enemy air defenses (SEAD): (interrupted, continuous, or non-standard)	
Gun target line (GTL) or Line of Fire (LOF): (max ordinate)	
Restrictions:	
Time on Target (TOT):	

**Figure 4-3 JFO Target Brief (JP 3-09.3)**

Game Plan and 9-Line CAS Brief	
Do not transmit the numbers. Units of measure are standard unless briefed. Lines 4, 6, and any restrictions are mandatory readbacks. The joint terminal attack controller (JTAC) may request an additional readback.	
JTAC: “ , advise when ready for game plan.”	
JTAC: “Type (1, 2, 3) control (method of attack, effects desired or ordnance, interval). Advise when ready for 9-line.”	
1. IP / BP: “	”
2. Heading: “ degrees magnetic, initial point or battle position-to-target	”
Offset: “ left or right, when requested	”
3. Distance: “ initial point-to-target in nautical miles, battle position-to-target in meters	”
4. Target elevation: “ in feet, mean sea level	”
5. Target description: “	”
6. Target location: “ latitude and longitude or grid coordinates, or offsets or visual	”
7. Type mark / terminal guidance : “ description of the mark, if laser handoff, call of sign lasing platform and code	”
8. Location of friendlies: “ from target, cardinal direction and distance in meters	”
Position marked by: “	”
9. “Egress	”
Remarks / *restrictions:	
<ul style="list-style-type: none"> <li>• Laser to target line (LTL) / pointer target line (PTL)</li> <li>• Desired type and number of ordnance or weapons effects (if not previously coordinated).</li> <li>• Surface-to-air threat, location, and type of SEAD.</li> <li>• Additional remarks (e.g., gun-to-target line, weather, hazards, friendly marks).</li> <li>• Additional calls requested.</li> <li>• *Final attack headings or attack direction.</li> <li>• *Airspace coordination areas (ACAs).</li> <li>• *Danger close and initials (if applicable).</li> <li>• *Time over target (TOT) / time to target (TTT).</li> <li>• *Post launch abort restrictions (if applicable).</li> <li>• IP – initial point</li> <li>• BP – battle position</li> </ul>	
Note: For off axis weapons, the weapons final attack heading may differ from the aircraft heading at the time of release. The aircrew should inform JTAC when this occurs and ensure weapon final attack headings comply with given restrictions.	

Figure 4-4 CAS 9 line (ATP 3-09.32)

## ARMY ATTACK AVIATION REQUEST

4-82. Army attack aviation call for fire can be used for all threat conditions. It does not affect the aircrew's tactics in executing attacks. When operating in close proximity to friendly forces, the AMC or flight lead must have direct communication with the ground commander or observer on the scene to provide direct fire support. After receiving the army attack aviation call for fire from the ground forces, the aircrews must positively identify the location of the friendly element and the target prior to conducting any engagement. Methods for marking the location of friendlies and the enemy include, but are not limited to: laser hand off, tracer fire, marking rounds (flares or mortars), smoke grenades, signal mirrors, VS-17 panels, IR strobe lights, laser target marker, or chemical sticks. See figure 4-5 on page 4-15.

<b>ROTARY WING 5-LINE REQUEST</b>
<ol style="list-style-type: none"> <li>1. Observer and Warning Order:</li> <li>2. Friendly Location and Mark:</li> <li>3. Target Location</li> <li>4. Target Description and Mark</li> <li>5. Remarks</li> </ol>
<p><b>Notes:</b></p> <ul style="list-style-type: none"> <li>-Clearance. If airspace has been cleared between the employing aircraft and the target, transmission of this brief is clearance to fire unless "danger close" or "at my command" is stated.</li> <li>-Danger Close. For danger close fire, the observer or commander, must accept responsibility for increased risk. State "cleared danger close" line 5 and pass the initials on the on-scene ground commander. This clearance may be preplanned.</li> <li>- At My Command. For positive control of the aircraft, state "at my command" on line 5. The aircraft will call "ready to fire", when ready.</li> </ul>

**Figure 4-5 Rotary Wing 5-Line Request (JP 3-09.3)**

## NAVAL SURFACE FIRE SUPPORT REQUEST

4-83. On most occasions when NSFS is available, elements of an air and naval gunfire liaison company (ANGLICO) will be attached to the appropriate Army unit. Normally, at the maneuver company level, a firepower control team will be attached to control and coordinate naval surface fire support. If a NSFS spotter is not available, the FIST is responsible to call for and adjust NSFS. It is essential for the company or troop FSO to be aware of these differences in order to accomplish the mission in a timely manner.

... To perform the duty of providing naval gunfire, the observer must communicate effectively with the fire support ship. To do this with the least confusion and the greatest speed, the observer uses a standardized call for fire. The call for fire is transmitted to the ship in two transmissions, consisting of six elements, with a read-back break after each transmission. Figure 4-5 on page 4-15 and/or figure 4-6 on page 4-16.

Naval Surface Fire Support Call for Fire (Grid / Polar Plot / Shift from a Known Point)
<b>First Transmission (spotter ID, warning order to include target #)</b>
" (SHIPS CALL SIGN) , this is (OBSERVERS CALL SIGN) , fire mission, target # (ASSIGNED BY OBSERVER) , over."
<b>Second Transmission (grid, polar plot or shift from a known point, to include target description, method of engagement, method of control)</b>
<b>Target Location—Grid</b>
"Grid (5 DIGIT MINIMUM) altitude (METERS MEAN SEA LEVEL) , direction (MILS / DEGREES) ."
<b>Target Location—Polar Plot</b>
"Direction " in mils / deg (to nearest 10 mils / deg) "Distance " in meters (to nearest 100m) "Up / down (VERTICAL SHIFT) " in meters (to nearest 5m)
<b>Target Location—Shift from a Known Point</b>
"Shift (TARGET NUMBER / REF POINT)
"Direction (OBS. TO TARGET) " in mils / deg (to nearest 10 mils / deg) "Left / right (LATERAL SHIFT) " in meters (to nearest 10m) "Add / drop (RANGE SHIFT) " in meters (to nearest 100m) "Up / down (VERTICAL SHIFT) " in meters (to nearest 5m)
Target Description: (type, size, degree of protection). Method of Engagement: (danger close, trajectory, ammo, fuze type, # guns, # salvos, special instructions). Method of Control: (spotter adjust, ship adjust, fire for effect, cannot observe, at my command) "Over".
<b>Pre-firing Report (Spotter Reads Back)</b>
"Gun-target line (from gun to target) Line of fire (if firing illumination)  First salvo at (danger close missions only) MAXORD (in feet for air spotter, meters for ground spotter) Changes to call for fire  Ready, Time of flight (time of flight in seconds)"
"FIRE OVER" (command from spotter after pre-firing report is read back)
Legend: MAXORD-maximum ordinate

Figure 4-6 Naval Surface Fire Support Request (ATP 3-09.32)

## AUTHENTICATION

4-85. Although improvements in communication security have allowed us to operate without authentication codes, the following procedures may still apply during degraded communication security situations. The two methods of authentication authorized for use are the challenge and reply and the transmission authentication. The operational distinction between the two is that challenge and reply requires two way communications, whereas transmission authentication does not. For instructions on authentication procedures, refer to the communications electronics operating instructions in the appropriate technical manual and unit standard operating procedure.

## CHALLENGE AND REPLY

4-86. When nonsecure communications are used and excluding unique fire support operations (such as immediate suppression), consider challenge and reply authentication as a normal element of initial requests for indirect fire. The FDC inserts the challenge in the last read back of the fire request. The observer transmits the correct authentication reply to the FDC immediately following the challenge. Authentication replies exceeding 20 seconds are automatically suspect and a basis for re-challenge. Subsequent adjustment of fire or immediate engagement of additional targets by the observer originating the initial fire request normally would not require continued challenge by the FDC.



## TRANSMISSION AUTHENTICATION

4-87. Use transmission authentication if authentication is required and it is not possible or desirable for the receiving station to reply; for example, imposed radio silence, final protective fire (FPF), and immediate suppression.

### Example

Transmission authentication for an FPF is **FIRE THE FPF. AUTHENTICATION IS WHISKEY HOTEL, OVER.**

### Example

Transmission authentication for immediate suppression is **T23 THIS IS T44 IMMEDIATE SUPPRESSION, GRID NK124321 ALTITUDE 345, AUTHENTICATION IS TANGO GOLF, OVER.**

## FDC COMMANDS

4-88. Fire commands are used by the fdc to give the howitzer sections all the information necessary to start, conduct, and cease firing. In a battery without bcs, fire commands must be sent by voice.

### L A I D

4-89. The FDC transmits the term **L A I D** after the gun(s) have been laid on the firing data but the round has not been fired. The FO will receive this command after sending a CFF as “Do Not Load” or after establishing a priority target. The observer acknowledges with **L A I D, O U T**.

### R E A D Y

4-90. The FDC transmits the term **R E A D Y** after the gun(s) have been laid and the round has been loaded. The observer will receive this command after sending a CFF as “At My Command” or “By Round, At My Command.” The observer acknowledges with **R E A D Y, O U T**.

### S H O T

4-91. The FDC transmits the term **S H O T** after each round fired in adjustment and after the initial round.

### S P L A S H

4-92. The FDC transmits the term **S P L A S H** to inform the observer when the round is five seconds from detonation. The FDC transmits splash during high angle fire, when firing in support of an aerial observer, or when requested. The observer responds with **S P L A S H, O U T**.

### R O U N D S C O M P L E T E

4-93. The term **R O U N D S C O M P L E T E** is used to signify the number of rounds specified in the fire for effect have been fired. The observer responds with **R O U N D S C O M P L E T E, O U T**.

## SAMPLE MISSIONS

4-94. Tables 4-1 through 4-5 (pages 4-18 through 4-19) are sample calls for fire for various types of missions.

Table 4-1. Fire mission (grid) initial fire request

Observer	Fire Direction Center
Z57 THIS IS Z71, ADJUST FIRE, OVER.  GRID NK180513 ALTITUDE 345, OVER.  INFANTRY PLATOON IN THE OPEN, ICM (improved conventional munitions) IN EFFECT, OVER.  I AUTHENTICATE (if required) CHARLIE, OUT.	Z71 THIS IS Z57, ADJUST FIRE OUT.  GRID NK180513 ALTITUDE 345, OUT.  INFANTRY PLATOON IN THE OPEN, ICM IN EFFECT, AUTHENTICATE (if required) PAPA BRAVO, OVER.
Message to Observer (MTO)	
MTO, ZEBRA, 2 ROUNDS, TARGET AF1027, BREAK, DIRECTION 1680, OVER.	MTO, ZEBRA, 2 ROUNDS, TARGET AF1027, OVER.
<b>Note.</b> Send direction before or with the first subsequent correction.	
MTO message to observer	

Table 4-2. Fire mission (shift) initial fire request

Observer	Fire Direction Center
H66 THIS IS H44, ADJUST FIRE SHIFT AA7733, OVER.  DIRECTION, 5210, LEFT 380, ADD 400, DOWN 35, OVER.  COMBAT OBSERVATION POST IN OPEN, VT IN EFFECT, OVER.  I AUTHENTICATE (if required) PAPA, OUT.	H44 THIS IS H66, ADJUST FIRE SHIFT AA7733, OUT.  DIRECTION, 5210, LEFT 380, ADD 400, DOWN 35, OUT.  COMBAT OBSERVATION POST IN OPEN, VT IN EFFECT, AUTHENTICATE (if required) LIMA FOXTROT, OVER.
Message to Observer (MTO)	
MTO, HORSE, 1 ROUND, TARGET AA7742, OUT	MTO, HORSE, 1 ROUND, TARGET AA7742, OVER.
VT variable time	MTO message to observer

Table 4-3. Fire mission (polar) initial fire request

<i>Observer</i>	<i>Fire Direction Center</i>
THUNDER 56 THIS IS ANIMAL 31, FIRE FOR EFFECT, POLAR, OVER.  DIRECTION 4520, DISTANCE 2300, DOWN 35, OVER.  INFANTRY COMPANY IN OPEN, VT, OVER.  I AUTHENTICATE (if required) ECHO, OUT.	ANIMAL 31 THIS IS THUNDER 56, FIRE FOR EFFECT, POLAR, OUT.  DIRECTION 4520, DISTANCE 2300, DOWN 35, OUT.  INFANTRY COMPANY IN OPEN, VT, AUTHENTICATE (if required) TANGO FOXTROT, OVER.
<b>Message to Observer (MTO)</b>	
MTO, BANDIT, VT, 3 ROUNDS, TARGET AF2036, OUT.	MTO, BANDIT, VT (variable time), 3 ROUNDS, TARGET AF2036, OVER.
VT variable time	MTO message to observer

Table 4-4. Fire mission (suppression)

<i>Observer</i>	<i>Fire Direction Center</i>
H18 THIS IS H24, SUPPRESS AB3104, OVER.  I AUTHENTICATE (if required) DELTA, OUT.	THIS IS H18, SUPPRESS AB3104, AUTHENTICATE (if required) DELTA JULIET, OVER.

Table 4-5. Fire mission (immediate suppression)

<i>Observer</i>	<i>Fire Direction Center</i>
APACHE 18 THIS IS DELTA 24, IMMEDIATE SUPPRESSION, GRID 211432 ALTITUDE 345, AUTHENTICATION (if required) IS TANGO UNIFORM, OVER.	APACHE 18, IMMEDIATE SUPPRESSION, GRID 211432 ALTITUDE 345, OUT.
<b>Note.</b> A two gun section using two rounds of high explosive (HE) or variable time (VT) normally fires immediate suppression missions. However, the type of ammunition, units to fire, and volume may vary based on unit standing operating procedure (SOP).	

This page intentionally left blank.

## Chapter 5

# Adjustment of Fire

An observer's primary mission is the placement of timely and accurate fires on targets. If an observer can locate the target accurately, **FIRE FOR EFFECT** will be requested in the call for fire. Failure to locate the target accurately may result from poor visibility, deceptive terrain, poor maps, or the observer's difficulty in pinpointing the target. If the observer cannot locate the target accurately enough to warrant fire for effect, an adjustment may be conducted. Even with an accurate target location, if current firing data corrections are not available, the fire direction officer may direct that the observer conduct an adjustment. Normally, one gun fires in adjustment. Special situations in which more than one gun is used are noted throughout this discussion.

### ADJUSTING POINT

5-1. When it is necessary for the observer to adjust fire, an adjusting point must be selected. In area missions, the observer must select a well-defined point near the center of the target area on which to adjust the fire. The selected point is an adjusting point (see figure 5-1). The location of this point is included in the target location element of the call for fire in an area fire mission. In the conduct of a registration or destruction mission (precision fire), the adjusting point is the target itself.

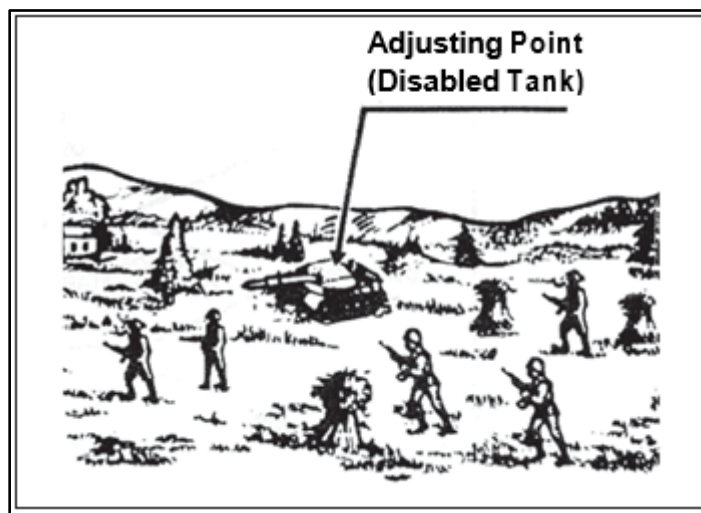

Figure 5-1. Adjusting point in an area fire mission

### SPOTTING

5-2. *Spotting* is the observer's determination of the location of the burst, or the mean point of impact of a group of bursts, with respect to the adjusting point as observed along the observer-target line. The observer should consider the most difficult spottings first. The sequence of spottings is HOB (air or graze), range (over or short), and deviation (left or right). Spottings are made for the following:

- When firing fuze time, the HOB (the number of meters the burst is above the target).
- Range (whether the burst occurred beyond or short of the target).
- Deviation (the number of mils right or left of the observer-target line).

5-3. The observer normally makes spottings the instant the bursts occur. However, delayed spottings sometimes provide additional information based on drifting smoke or dust. The observer is usually required to announce the spottings during early training; experienced observers make spottings mentally.

### HEIGHT OF BURST SPOTTING

5-4. The HOB spottings may be any one of the following:

- **Air**—A round or group of rounds that bursts in the air. The number of mils also is given. For example, spot a burst of 10 mils above the ground as **AIR 10**.
- **Graze**—A round or group of rounds that detonates on impact.
- **Mixed**—A group of rounds that results in an equal number of airbursts and graze bursts.
- **Mixed air**—A group of rounds that results in both airbursts and graze bursts when most of the bursts are airbursts.
- **Mixed graze**—A group of rounds that results in both airbursts and graze bursts when most of the bursts are graze bursts.

### RANGE SPOTTING

5-5. Definite range spottings are required to make a proper range adjustment. Normally a round which impacts on or near the observer-target line results in a definite range spotting. Figure 5-2 (on page 5-3) shows the approximate areas for various range spottings. Any range spotting other than DOUBTFUL, LOST, or UNOBSERVED is definite. An observer may make a definite range spotting when the burst is not on or near the observer-target line by using knowledge of the terrain, drifting smoke, shadows, and wind. However, even experienced observers must use caution and good judgment when making such spottings. Possible range spottings are:

- **Over**—A spotting of “**OVER**” is a round that impacts beyond the adjusting point.
- **Short**—A spotting of “**SHORT**” is a round that impacts between the observer and the adjusting point.
- **Target**—A spotting of “**TARGET**” is a round that impacts on the target. Use this spotting only in precision fire (registration or destruction missions).
- **Range Correct**—A spotting of “**RANGE CORRECT**” is a round that impacts at the correct range.
- **Doubtful**—A spotting of “**DOUBTFUL**” is a round that can be observed but cannot be spotted as “**OVER, SHORT, TARGET, or RANGE CORRECT.**”
- **Lost**—A spotting of “**LOST**” is a round whose location cannot be determined by sight or sound.
- **Unobserved**—A spotting of “**UNOBSERVED**” is a round not observed but known to have impacted (usually heard).

---

*Note.* For safety considerations regarding lost and unobserved rounds, refer to Army Regulation (AR) 385-63.

---

- **Unobserved over or short**—A spotting of “**UNOBSERVED OVER**” or “**UNOBSERVED SHORT**” is a round not observed but known to have impacted over or short.

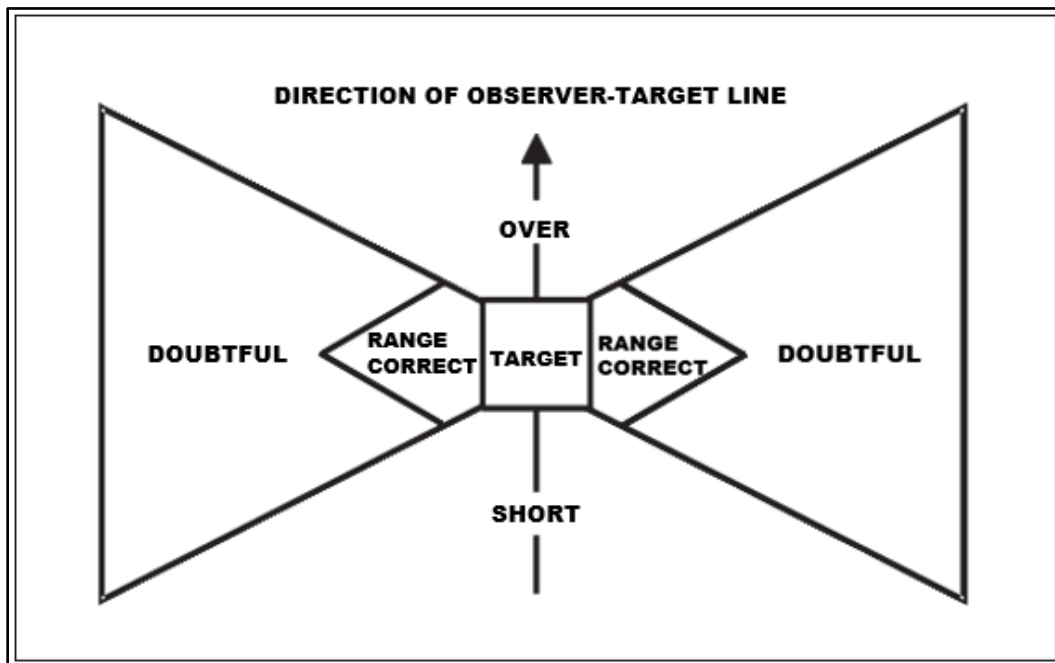

Figure 5-2. Range spotting

### DEVIATION SPOTTING

5-6. A deviation spotting is the angular measurement from the adjusting point to the burst as seen from the observer's position. During a fire mission, the observer measures the deviation in mils, with binoculars (or other angle measuring instrument). Visually interpolate deviation spottings to the nearest 5 mils for area fires and one mil for precision fires. The following are deviation spottings:

- **Line**—A spotting of “**LINE**” is a round that impacts on line with the adjusting point as seen by the observer (on the observer-target line).
- **Left**—A spotting of “**LEFT**” is a round that impacts left of the adjusting point in relation to the observer-target line.
- **Right**—A spotting of “**RIGHT**” is a round that impacts right of the adjusting point in relation to the observer-target line.

#### Example

An observer spots a round to the right of the observer-target line. The measured angular deviation is 40 mils. The deviation spotting is **40 RIGHT**.

5-7. Take deviation spottings from the center of a single burst or, in the case of platoon or battery fire, from the center of the group of bursts. Make deviation spottings as accurately as possible to help in obtaining definite range spottings.

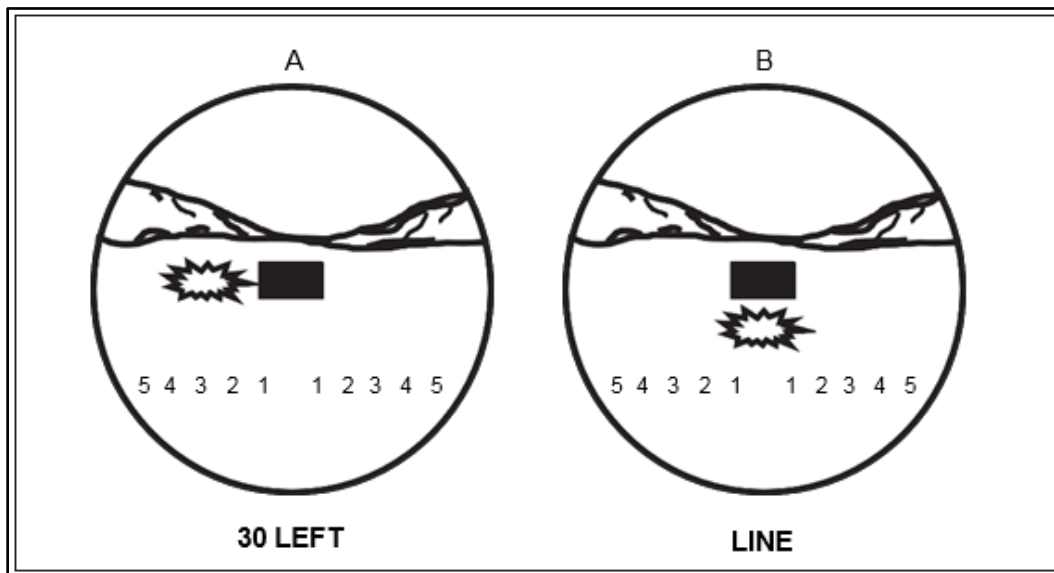

Figure 5-3. Deviation spottings

### UNOBSERVED SPOTTING

5-8. At times, the observer may be able to make a spotting even though the round impact may not be able to be seen.

#### Example

The observer hears but does not see the round impact, and the only possible place the round could have impacted and not been visible to the observer is in a ravine beyond the adjusting point. The burst is assumed to be beyond the adjusting point and spots it as **UNOBSERVED, OVER**.

### LOST SPOTTING

5-9. If the observer is unable to locate the round (either visually or by sound), the round is spotted **LOST**. A round may be lost for various reasons:

- It may be a dud (nonfunctioning fuze), resulting in no visual or audible identification.
- The terrain or weather may prevent the observer from spotting the round or its smoke.
- Adversary fire may prevent the observer from hearing or seeing the round.
- The forward observer simply may have failed to spot the round.
- Errors by the fire direction center (FDC) or the firing piece may cause the round to be lost.
- GPS malfunction or fin or canard deployment malfunction for a precision-guided munition.

5-10. When dealing with a lost round, the observer must consider own experience, the level of FDC and or gun section training, and the location of friendly elements with respect to the target. The observer should take corrective action based on the confidence in the target location, the accuracy of fire on previous missions; whether the lost round is an initial round or a subsequent round, and the urgency of the mission.

5-11. The observer must take one or more of the following corrective procedures when a round is lost:

- Begin a data check throughout the system, starting with the target location data and the call for fire.



- Request a white phosphorous (WP) round, a smoke round, or a 200 meter airburst with high explosive (HE) on the next round.
- Repeat.
- End the mission and start a new mission.
- Make a bold shift. The observer should be very careful in making bold range or deviation corrections when the target plots near friendly troops.

## TYPES OF CORRECTIONS

5-12. After making a spotting, the observer must send corrections to the FDC to move the burst onto the adjusting point. The observer sends corrections, in meters, in reverse of the order used in making spottings; that is, deviation, range, and HOB.

### DEVIATION CORRECTION

5-13. The distance, in meters, the burst is to be moved (right or left) is determined by multiplying the observer's deviation spotting in mils by the observer-target (OT) distance in thousands of meters (the observer- target factor). Express deviation corrections to the nearest 10 meters. A deviation correction of less than 30 meters is a minor deviation correction. The observer should not send minor deviation corrections to the FDC except as refinement data or in conduct of a destruction mission.

5-14. To determine the OT Factor when the observer-target range is greater than 1,000 meters, express the range from the observer to the target (OT distance) to the nearest thousand meters and then the expressed OT distance in thousands. When the range to the target falls half way in between a thousand (for example 1,500 meters or 3,500) meters the observer will round either up or down to the nearest even number.

#### Example

Observer-target range = 4,500 meters. Observer-target distance (expressed to nearest thousand) = 4,000. Observer-target factor (expressed in thousands) =4.

5-15. For an observer-target range less than 1,000 meters, express the distance to the nearest 100 meters and expressed in tenths.

#### Example

Observer-target range =800 meter. Observer-target factor = .8.

5-16. Announce the computed deviation correction to the FDC as **LEFT** (or **RIGHT**) (so **much**). The correction is opposite the spotting.

5-17. Table 5-1on page 5-6 provides examples of the determination of deviation corrections.

Table 5-1. Determination of deviation corrections

OT RANGE (METERS)	OT FACTOR	SPOTTING	DEVIATION CORRECTION
4,000	4	45R	LEFT 180
2,500	2	100L	RIGHT 200
3,400	3	55L	RIGHT 160
1,500	2	20R	LEFT 40
700	0.7	45L	RIGHT 30
<b>Legend.</b> L—left                      OT—observer-target                      R—right			

*Note.* Table 5-1 expresses 1,500 and 2,500 meters to the nearest even OT factor in order to maintain a common standard of expression. For example, an OT range of 3,500 meters will round up so that the OT Factor is 4, but if the OT range was 3,400 then the OT Factor would be 3.

5-18. If angle T is 500 mils or greater, the FDC should tell the observer. If the observer is told that angle T is 500 mils or greater, continue to use the observer-target factor to make the initial deviation correction. If the observer is getting more of a correction than asked for, the observer should consider cutting the corrections to better adjust rounds onto the target. When the guns are firing, the rounds will land in an elliptical shape pattern along the gun-target line. When angle T is in effect this may result in greater than expected deviation correction. To counteract this, an inexperienced observer should generally cut corrections by half to bring rounds on to the target. A more experienced observer will be able to cut the corrections as needed to move the rounds on to the target.

## RANGE CORRECTION

5-19. When making a range correction, the observer attempts to "add" or "drop" the adjusting round, along the observer-target line, from a previous burst to the target. If the spotting was **SHORT**, the observer will "add"; if the spotting was **OVER**, the observer will "drop". The observer must be aggressive in the adjustment phase of an adjust fire mission, and must use every opportunity to shorten that phase. The observer should make every effort to correct the initial round onto the target and enter fire for effect as soon as possible. Use successive bracketing procedures only when time is not critical. When conducting an adjustment onto a target, the observer may choose to establish a range bracket.



## HEIGHT OF BURST CORRECTION

5-20. Figure 5-4 shows height of burst corrections.

5-21. Use one gun in adjusting fuze time. The observer adjusts HOB (after a 100 meter range bracket has been established by using fuze quick) to obtain a 20 meter HOB in fire for effect. This is done by announcing a correction of UP or **DOWN (so many meters)**.

5-22. If the spotting of the initial round is **GRAZE**, an automatic correction of **UP 40** is sent. If the round is an airburst, the HOB of the round (in meters) is computed (HOB spotting in mils above the adjusting point multiplied by the observer-target factor). The appropriate HOB correction is given (to the nearest 5 meters) to obtain the desired 20 meter HOB.

5-23. Enter the fire for effect phase only when a correct HOB is reasonably assured. Therefore, do not begin the fire for effect phase when the spotting for the previous round **GRAZE** or the HOB correction is greater than 40 meters. If the spotting for the initial rounds in fire for effect is **MIXED**, the subsequent surveillance report normally includes the correction **UP 20**.

<p style="text-align: center;">Spotting: <b>Graze</b></p> 	<p>Height of Burst Correction:</p> <p>(without previous airburst) <b>UP 40.</b></p> <p>(with previous airburst) <b>UP 20.</b></p>
<p style="text-align: center;">Spotting: <b>Air (# of mils)</b></p> 	<p>Height of Burst Correction:</p> <p>Correct to 20 meter height of burst and fire for effect.</p>

**Figure 5-4. Height of burst corrections**

## SEQUENCE OF SUBSEQUENT CORRECTIONS

5-24. After the initial round(s) impact(s) the observer transmits subsequent corrections until the mission is complete. These corrections include appropriate changes in elements previously transmitted and the necessary corrections for deviation, range, and HOB. Elements that may require correction and the order in which they are announced are:

- Observer Target Direction.
- Danger close and cancel danger close.
- Trajectory.
- Method of fire.
- Distribution.
- Projectile.
- Fuze.
- Volume.
- Deviation.
- Range.
- Height of burst.
- Target Description.
- Mission type and method of control.
- Splash.
- Repeat.

5-25. Any element for which a change or correction is not desired is omitted. Guidelines for subsequent corrections are discussed below.

### OBSERVER TARGET DIRECTION

5-26. In the sequence of corrections, the observer target direction is the first item sent to the FDC. The observer must send a grid direction. If the observer is employing a magnetic compass the direction must be converted to grid azimuth before being sent to the FDC. If the observer is using a declinated M2 compass, then the conversion to grid azimuth is already complete. Send the observer-target direction if it has not been sent previously or if the observer-target direction changes by more than 100 mils from the previously announced direction. (Normally, the observer sends direction to the nearest 10 mils but can send it to the nearest one mil depending on the accuracy of the equipment used.)

### Example

An observer began an adjustment on several enemy vehicles and used a tree at direction 5620 as the adjusting point. During the adjustment, the enemy vehicles moved to a new position an appreciable distance from the initial adjusting point. The observer selects a new adjusting point and measures a direction of 5840 to the new point. Since the difference between the directions to the old and new adjusting points exceeds 100 mils, the first element in the observer's next correction is **DIRECTION 5840**.

### DANGER CLOSE AND CANCEL DANGER CLOSE

5-27. If the adjustment of fires brings impacting rounds within danger close distance during the conduct of the mission, the observer must announce **DANGER CLOSE** to the FDC. The observer makes corrections from the round impacting closest to friendly troops using the creeping fire technique discussed in Section II, Creeping Fire (Danger Close). If the adjustment of fires moves the round outside the danger close distance, the observer transmits **CANCEL DANGER CLOSE**.

### TRAJECTORY

5-28. The observer requests a change in the type of trajectory if it becomes apparent that high angle fire is necessary during a low angle adjustment or that high angle fire is no longer necessary during a high angle adjustment. For example, if during the conduct of the mission a target moves into a defilade position, the observer may change trajectory by transmitting the correction **HIGH ANGLE**. Conversely, if a target moves out of defilade into open terrain and high angle fire is no longer necessary, the observer requests **CANCEL HIGH ANGLE**.

### METHOD OF FIRE

5-29. The observer transmits any correction that is necessary in the method of fire. For example, if the observer wants to change from one gun to a platoon firing in order from left to right, the correction sent is **PLATOON LEFT**. If wanting to change a platoon firing in order from right to left, the correction sent is **PLATOON RIGHT**.

### DISTRIBUTION

5-30. If an observer wants to change the distribution of fire from an artillery computer system sheaf (circular with a 100 meter radius) to another type of sheaf, the observer requests the sheaf desired (**CONVERGED**, **OPEN**, or **LINEAR** or the target length, width, and attitude). Conversely, if the observer wants to change from a specific sheaf to an artillery computer system sheaf, the transmission sent is **CANCEL**, followed by the type of sheaf being used (for example, **CANCEL CONVERGED [or OPEN] SHEAF**).

### PROJECTILE

5-31. If the observer wants to change the type of projectile, the observer announces the desired change (for example, **SMOKE** or **WP**).

### FUZE

5-32. If the observer wants to change the type of fuze or fuze action, the observer announces the desired change (for example, **TIME**, **DELAY**, or **VT** [variable time]).

### VOLUME

5-33. If the observer want to change the volume of fire, the observer announces the desired change (for example **2 ROUNDS** or **3 ROUNDS**). Volume refers to the number of rounds in the fire for effect phase.

## DEVIATION

5-34. The distance, in meters, the burst is to be moved (right or left) is determined by multiplying the observer's deviation spotting in mils by the observer-target distance in thousands of meters (the observer-target factor). Express deviation corrections to the nearest 10 meters. A deviation correction of less than 30 meters is a minor deviation correction. The observer should not send minor deviation corrections to the fire direction center except as refinement data or in conduct of destruction missions.

5-35. Announce the computed deviation correction to the fire direction center as "**LEFT**" or "**RIGHT**" (**deviation correction in meters**). The correction is opposite the spotting (a left spotting would result in a correction to the right).

## RANGE

5-36. When making a range correction, the observer attempts to "add" or "drop" the adjusting round, along the observer-target line, from a previous burst onto the target. If the spotting was "**SHORT**", will add; if the spotting was "**OVER**", will drop.

## HEIGHT OF BURST

5-37. Use one gun in adjusting fuze time. The observer adjusts height of burst (after a 100 meter range bracket has been established by using fuze quick) to obtain a 20 meter height of burst in fire for effect. This is done by announcing a correction of "**UP**" or "**DOWN**" (**so many meters**).

5-38. If the spotting of the initial round is "**GRAZE**", an automatic correction of "**UP 40**" is sent. If the round is an airburst, the height of burst of the round (in meters) is computed (height of burst spotting in mils above the adjusting point multiplied by the observer-target factor). The appropriate height of burst correction is given (to the nearest 5 meters) to obtain the desired 20 meter height of burst.

5-39. Enter the fire for effect phase only when a correct height of burst is reasonably assured. Therefore, do not begin the fire for effect phase when the spotting for the previous round "**GRAZE**" or the height of burst correction is greater than 40 meters. If the spotting for the initial rounds in fire for effect is "**MIXED**" the subsequent refinement includes the correction "**UP 20.**"

## TARGET DESCRIPTION

5-40. Send the target description before a control correction during immediate suppression missions and when attacking a new target without sending a new call for fire.

## MISSION TYPE AND METHOD OF CONTROL

5-41. If the observer wants to change the mission and method of control, the observer transmits the desired method of control (for example, **ADJUST FIRE**, **FIRE FOR EFFECT**, or **AT MY COMMAND**). If the current method of control includes **AT MY COMMAND**, the correction is **CANCEL AT MY COMMAND**.

## SPLASH

5-42. An observer may have difficulty identifying or observing the rounds. This may be because the observer has to stay down in a concealed position much of the time or because of other fire missions in the area. In any case, the observer may request assistance from the FDC by requesting **SPLASH**. The FDC informs the observer that the round is about to impact by announcing **SPLASH** 5 seconds before the round impacts. The observer may end splash by announcing **CANCEL SPLASH**.

## REPEAT

5-43. **REPEAT** is used (in the adjustment phase) if the observer wants a subsequent round or group of rounds fired with no corrections to deviation, range, or HOB (for example, **TIME, REPEAT**). **REPEAT** is also used by the observer to indicate what is wanted, **fire for effect** repeated with or without changes or corrections to any of the elements (for example, **ADD 50, REPEAT**).

## ADJUSTMENT TECHNIQUES

5-44. Four techniques can be used to conduct area adjustment fires:

- **Successive bracketing** is best when observers are inexperienced or when precise adjustment is required, such as precision registrations and destruction missions. It mathematically ensures fire for effect rounds will be within 50 meters of the target.
- **Hasty bracketing** is best when responsive fires are required and the observer is experienced in the adjustment of fire.
- **One round adjustment** provides the most responsive fires but generally requires either an experienced observer or an observer equipped with a laser range finder.
- **Creeping fire** is best used on danger close missions and other missions requiring the observer to make small adjustments to bring fires onto the target in order to minimize collateral damage.

5-45. Upon completion of each mission, refinement data and surveillance are required. From this surveillance, the FDC can determine the effectiveness of fires.

## SUCCESSIVE BRACKETING

5-46. After the first definite range spotting is determined, the observer should send a range correction to the FDC to establish a range bracket of known distance (one round over and one round short). Once the observer establishes the bracket, successively splits the bracket until confident that the rounds will impact within 50 meters of the adjusting point when requesting fires for effect. Normally, range changes of 100, 200, 400, or 800 meters are used to make splitting the bracket easier (see figure 5-5). The observer enters fire for effect when the rounds impact within 50 meters of the adjusting point.

### Example

The first round (1) impacts over the adjusting point (see figure 5-5). The observer should send a drop correction enough to place the next round short of the adjusting point.

The observer sent **DROP 400** (-400) after observing his first round. The next round (2) impacted short of the adjusting point.

The observer has now established a range bracket, with one round over and one round short of the adjusting point, separated by 400 meters. Using the successive bracketing technique, the observer sends **ADD 200** (+200).

The third round (3) impacts over the adjusting point. The observer has a 200 meter bracket because round 2 impacted short of the adjusting point and the distance between the two rounds was 200 meters. Splitting the bracket, the observer sends **DROP 100** (-100).

The fourth round (4) impacts short. The observer has established a 100 meter bracket and now sends **ADD 50, FIRE FOR EFFECT**. The center of impact of the fire for effect rounds is now mathematically certain of being within 50 meters of the adjusting point.

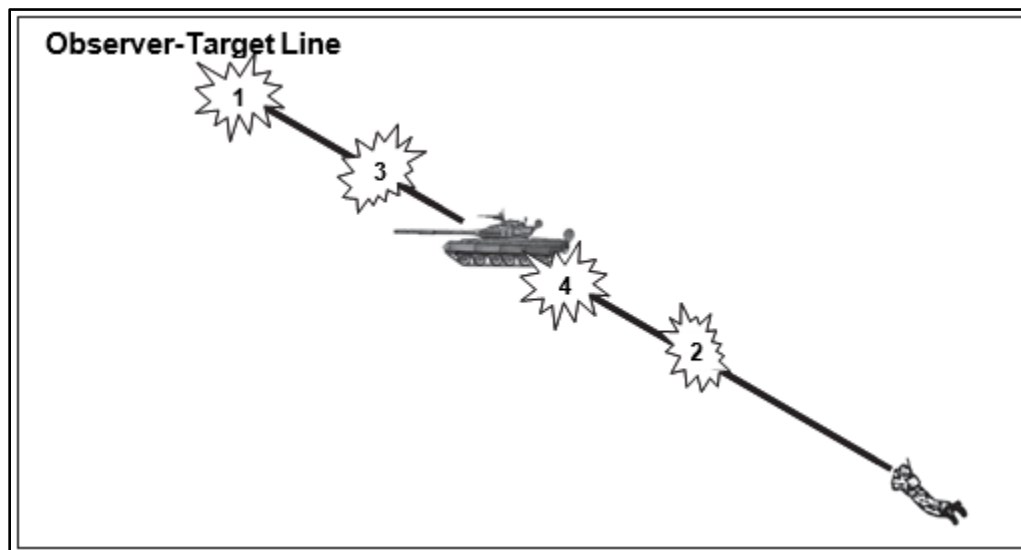

Figure 5-5. Successive bracketing technique

### HASTY BRACKETING

5-47. Successive bracketing mathematically ensures the observer that the fire for effect rounds will impact within 50 meters of the adjusting point. However, experience has shown the effectiveness of a fire for effect on the target decreases as the number of rounds used in adjustment increases. The adjusting rounds warn the target of an impending fire for effect, causing the target to seek cover or leave the area.

5-48. An alternative to successive bracketing is the hasty bracketing technique (see Figure 5-6 on page 5-12). If the nature of the target dictates that effective fires are required in less time than the successive bracketing technique would take, use the hasty bracketing technique. The success of hasty bracketing adjustment depends on accurate initial target location.

5-49. The observer gets a bracket on the first correction much as in the successive bracketing technique. The observer uses this initial bracket as a yardstick to determine the subsequent correction. The observer sends the FDC the correction to move the rounds to the target and **FIRE FOR EFFECT**.

### Example

The first round (1) impacts approximately 35 mils right and 100 meters short of the adjusting point (see figure 5-6). The observer spots it as **SHORT, 35 RIGHT**. With an observer-target factor of 4, the observer sends **LEFT 140, ADD 200**.

The next round (2) impacts approximately 10 mils left and 50 meters over the adjusting point. The observer spots it as **OVER, 10 LEFT**. The observer looks at the round and the adjusting point and determines the need to go right 40 meters (10 X observer-target factor of 4) and drop 50. The observer will then be on the adjusting point. Therefore, sends **RIGHT 40, DROP 50, FIRE FOR EFFECT**.

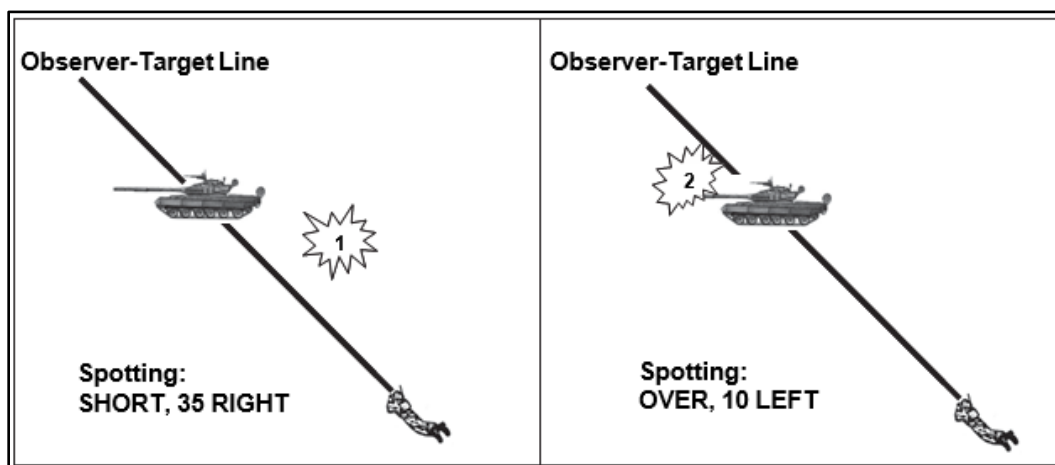

Figure 5-6. Hasty bracketing technique

### ONE ROUND ADJUSTMENT

5-50. Unlike the preceding two adjustment techniques, this method does not require the establishment of a bracket. The observer spots the location of the first round, calculates and transmits to the FDC the corrections necessary to move the burst of the round to the adjusting point, and fires for effect. This technique requires an experienced observer or one with accurate distance measuring equipment such as a laser rangefinder. Normally, all missions conducted by using a laser designator and rangefinder should be fire for effect or one round adjustment.

### DANGER CLOSE

5-51. Use the creeping fire method of adjustment during danger close missions. The observer should make range changes by creeping the rounds to the target, using corrections of 100 meters or less, rather than making large range corrections.

5-52. The observer may also use creeping fire in special situations where the potential for collateral damage requires exceptional care to limit unwanted damage to structures or vehicles close to the target.



## FIRE FOR EFFECT

5-53. The purpose of area fire is to create the greatest possible effects on the target by covering the target area with dense fire. The type and amount of ammunition requested by the observer depend on the type of target, its posture, and its activity. Fire for effect is entered during an adjust fire mission when a satisfactory adjustment has been obtained; that is, when deviation, range, and HOB (if firing fuze time) have been corrected to provide effects on target.

5-54. Normally, the observer using successive bracketing requests fire for effect once the 100 meter bracket is split. Under certain conditions when the  $PE_R$  of the weapon is 38 meters or larger, an observer is justified in calling for fire for effect when a 200 meter bracket is split. (In this situation, the FDC notifies the observer that the  $PE_R$  is greater than 38 meters.)

5-55. If fuze time is used, the observer requests **FUZE TIME** after correcting range and deviation but before announcing **FIRE FOR EFFECT**. With fuze time, the observer does not request fire for effect until the HOB is correct or until the observer can compute the correction that should result in the correct HOB.

5-56. In splitting the 100 meter bracket, the correction is **TIME, ADD (or DROP) 50, OVER**. If range and HOB are correct (20 meters above the ground), the observer sends **FIRE FOR EFFECT, OVER**.

5-57. After requesting **FUZE TIME**, the observer does not send any more range or deviation corrections to the FDC.

5-58. If the observer spots a round with fuze time as a graze burst and there have been no previous airbursts, the correction is **UP 40, OVER**.

5-59. If the observer spots a round with fuze time as a graze burst and the observer has spotted a previous airburst, the correction is **UP 20, OVER**.

5-60. If the observer spots an airburst, the correction to achieve a 20 meter HOB and fire for effect should be sent. For example, if the HOB of the last round is 40 meters, the correction is **DOWN 20, FIRE FOR EFFECT, OVER**.

5-61. Do not fire for effect :

- From a graze burst.
- If the correction is greater than **DOWN 40**.

## REFINEMENT AND SURVEILLANCE

5-62. The observer should observe the results of the fire for effect and then take whatever action is necessary to complete the mission. Table 5-2 on page 5-14 shows the observer's actions and example transmissions after observing the fire for effect rounds.

Table 5-2. Refinement and surveillance

<b>RESULTS OF FIRE FOR EFFECT</b>	<b>OBSERVER'S ACTIONS</b>	<b>OBSERVER'S TRANSMISSION</b>
Accurate and sufficient	End mission and surveillance	END OF MISSION, ROCKET PROPELLED GRENADE DESTROYED, OVER.
Accurate and sufficient; replot desired	Request replot, end mission and surveillance	RECORD AS TARGET, END OF MISSION, BMP NEUTRALIZED, OVER.
Inaccurate and sufficient	Refinement, end mission and surveillance	RIGHT 20, ADD 20, END OF MISSION, ROCKET PROPELLED GRENADE DESTROYED, OVER.
Inaccurate, sufficient, target replot desired	Refinement, request replot, end mission and surveillance	RIGHT 30, RECORD AS TARGET, END OF MISSION, BMP NEUTRALIZED, OVER.
Inaccurate and insufficient	Correction and repeat	RIGHT 30, ADD 50, REPEAT.
Inaccurate and insufficient	Correction and transition to adjust fire	RIGHT 30, ADD 100, ADJUST FIRE, OVER.
Accurate and insufficient	Repeat	REPEAT, OVER.

## TYPES OF CORRECTIONS

5-63. Registrations and destruction missions fired with area munitions place a great deal of responsibility on the observer. In registration and destruction missions, the adjusting point must be accurately located. At a minimum, the observer should send an eight digit grid. If the observer is equipped with a device capable of a more accurate target location, then a more precise grid should be sent to the FDC.

---

*Note.* Registration and destruction missions fired with area munitions, by their nature, require high ammunition expenditure and make the firing unit vulnerable to adversary target acquisition.

---

## REGISTRATION

5-64. The firing unit conducts a registration with a single piece. Normally, the fire direction officer directs the observer to conduct the registration on a designated point; however, the FDC may direct the observer to select the registration point. The registration point should be accurately located (within 10 meters), near the center of the zone of fire, semi-permanent, located on fairly level terrain if possible, and on common grid with the firing unit.

## INITIATION

5-65. Initiate the registration with a message to observer as shown tables 5-3 and 5-4.

Table 5-3. Registration on a known point

<i>Observer</i>	<i>Fire Direction Center</i>
	H18 THIS IS H44, REGISTER ON KNOWN POINT 2, QUICK AND TIME <sup>1</sup> , OVER.
THIS IS H18, REGISTER ON KNOWN POINT 2, QUICK AND TIME, OUT.	
	DIRECTION 6400, OVER.
DIRECTION 6400, OUT. <sup>2</sup>	
	SHOT, OVER.
SHOT, OUT.	
<b>Notes.</b> <sup>1</sup> The announcement of quick and time alerts the observer that the impact and time portions must be conducted. <sup>2</sup> The forward observer's response to the FDC indicates ready to observe.	

Table 5-4. Registration on a point selected by observer

<i>Observer</i>	<i>Fire Direction Center</i>
	APACHE 18 THIS IS THUNDER 44, SELECT REGISTRATION POINT VICINITY GRID NK6138, QUICK AND TIME, OVER.
THIS IS APACHE 18, SELECT REGISTRATION POINT VICINITY GRID NK6138, QUICK AND TIME, OUT.	
GRID NK61243843 <sup>1</sup> , ALTITUDE 345 DIRECTION 6310, OVER. <sup>2</sup>	
	GRID NK61243843, ALTITUDE 345 DIRECTION 6310, OUT.
	SHOT, OVER.
SHOT, OUT.	
<b>Notes.</b> <sup>1</sup> The forward observer sends a minimum of eight digit grid coordinates for the registration <sup>2</sup> Indicates the forward observer is ready to observe.	

## IMPACT REGISTRATION

5-66. The objective of a registration is to get spottings of four rounds (two overs and two shorts) along the observer-target line from rounds fired with the same data or from rounds fired with data 25 meters apart (50 meters apart when  $PE_R$  is greater than or equal to 25 meters). Normally this requires the spottings from four separate rounds. However, a target hit or a round spotted as range correct provides spottings for both over and short. Thus, the observer could achieve the objective with two consecutive target hits or range correct spottings.

5-67. The observer spots the rounds for deviation to the nearest one mil and brings the rounds onto the observer-target line before splitting a 200 meter bracket. As a rule of thumb, the observer should not make deviation corrections after establishing a 200 meter bracket. Once the observer brings the rounds onto the observer-target line, the deviation is measured and recorded but makes no correction. If the range spotting is doubtful, the observer corrects for deviation only. If the observer makes a deviation correction after a 200 meter bracket is established, no previous rounds, including the last round fired, are usable rounds for determining range and deviation refinement data.

5-68. When the 50 meter range bracket has been established, two rounds are fired with data 25 meters in the direction opposite that of the last range spotting. If both rounds result in spottings of short (or over), a correction of add (or a drop) of 25 meters with a change in volume to one round is sent. The observer continues firing until obtaining another definite range spotting at the opposite end of the 25 meter range bracket.

5-69. After achieving the requirement of two overs and two shorts with the same data or data fired 25 meters apart has been met, the impact registration is ended with necessary refinement data. Refinement data may include either a deviation correction or a range correction, or both, to the nearest 10 meters.

5-70. In determining refinement data for range, the location of the registration point is determined with respect to the two sets of spottings. Then refinement data are determined and announced. The criteria for determining range refinement data are discussed below.

5-71. If the registration point is nearer the last round(s) fired, no range refinement is necessary to move the impact toward the registration point (see figure 5-7).

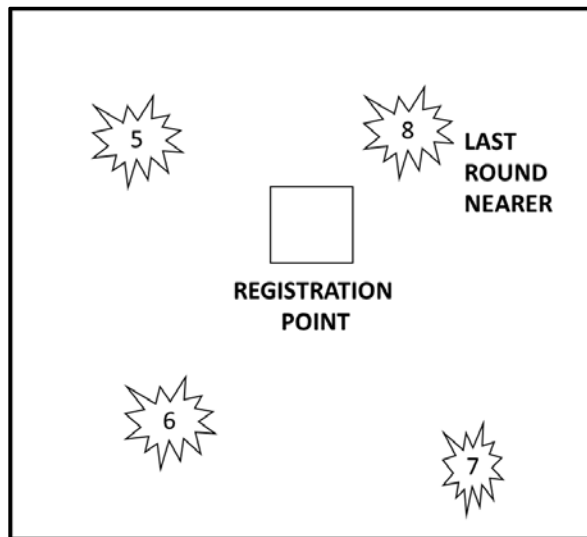

**Figure 5-7. No range refinement necessary**

5-72. If the registration point is equidistant between the two sets of rounds, the observer determines the range refinement to be **ADD 10** or **DROP 10** from the last data fired (see figure 5-8).

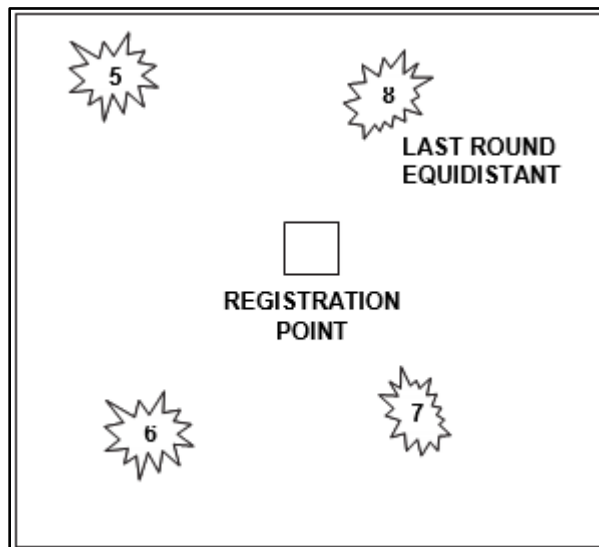

**Figure 5-8. Drop 10**

5-73. If the registration point is nearer the pair of rounds at the opposite end of the bracket, (instead of the last round) the observer determines the range refinement to be **ADD 20** or **DROP 20** (see figure 5-9 on page 5-16).

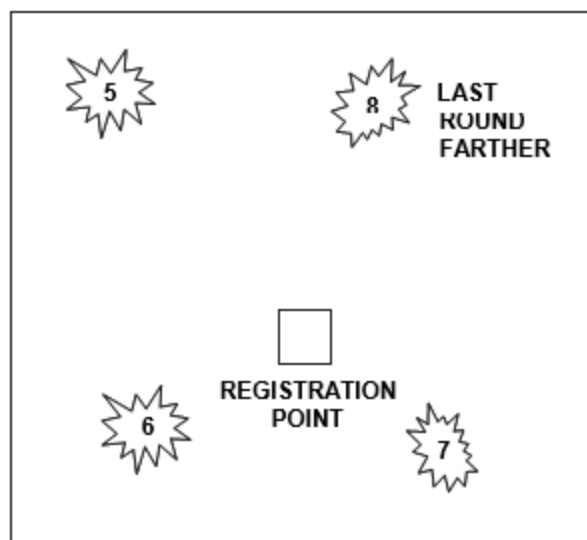

**Figure 5-9. Drop 20**

5-74. The observer must keep track of the rounds and spottings in relation to the registration point. Consider drawing a picture and numbering the rounds on DA Form 5429 (see figure 5-10 on page 5-18).

5-75. *Note.* A sketch is must in determining usable rounds on a precision registration.

CONDUCT OF FIRE						
For use of this form, see ATP 3-09.30; the proponent agency is TRADOC.						
SECTION I - CALL FOR FIRE						
1. OBSERVER Foxtrot 54		2. AF/FEAS/S FFE		3. TARGET AA1000		4. GRID 14SNV12345678
5. POLAR: DIRECTION 2604		6. POLAR: DISTANCE 3300		7. POLAR: UP/DOWN N/A		8. POLAR: VERTICAL ANGLE N/A
9. SHIFT N/A		10. DIRECTION 2604		11. LEFT/RIGHT Left 20		12. +/- -10
14. DESCRIPTION OF TARGET Truck in the open				15. METHOD OF ENGAGEMENT Improved Conventional Munitions (ICM)		
16. AMMUNITION/FUZE 155mm/VT				17. CONTROL At my Command (AMC)		
18. DIRECTION 2604		19. OT FACTOR 3		20. MESSAGE TO OBSERVER 2 rounds, Bravo Btry, Target Number AA1000		
CORRECTIONS <i>a</i>			SPOTTINGS <i>b</i>	ROUNDS <i>c</i>	REMARKS <i>d</i>	
DEVIATION	DISTANCE INITIAL ROUND	HEIGHT OF BURST				
+200	3500	UP 10	-8	1	N/A	
100	3400		-8R	2	N/A	
+50	3450		+2L	3	N/A	
-25	3400		+6R	4	N/A	
-25	3400		-8R	5	N/A	
+25	3400		-5R	6	N/A	
+25	3300		+7R	7	N/A	
			L20 -10, record as registration point 1		EOM	

DA FORM 5429, SEP 2017 PREVIOUS EDITIONS ARE OBSOLETE. Page 1 of 2 APD/LC/v1.06

EOM	end of mission	KN PT	known point
L	left	OT	observer target
R	right	REC	record
REG	register	REG PT	registration point

Figure 5-10. Example registration diagram, page 1

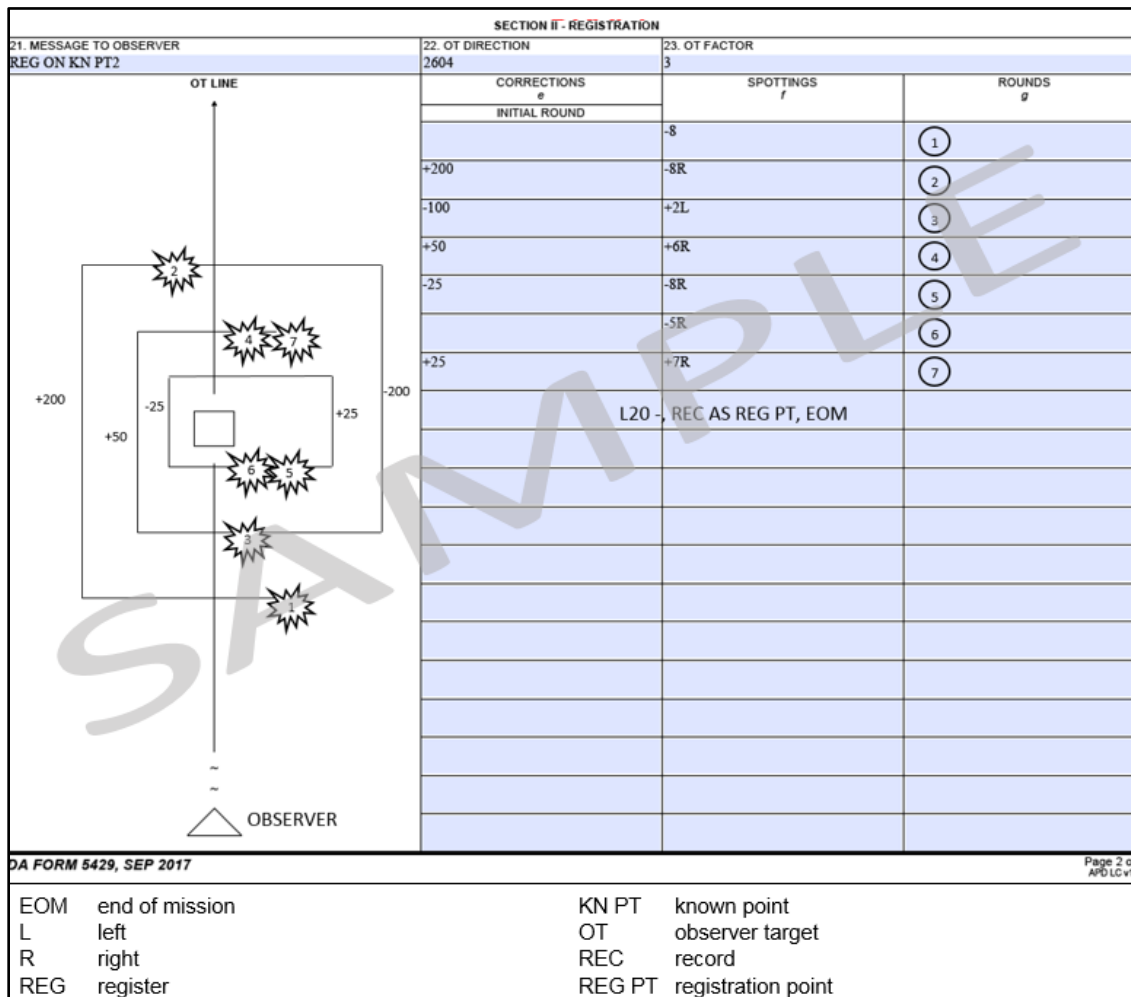

Figure 5-11. Example registration diagram, page 2

5-76. Deviation refinement is determined by adding the deviation spottings of the rounds establishing the two over and two short (this may include two, three, or four deviation spottings). Then divide the total of the deviation spottings by the number of rounds (two, three, or four) to get an average deviation. Express the result to the nearest mil. The average deviation multiplied by the observer-target factor equals the correction, which the observer expresses to the nearest 10 meters.

*Note.* Express deviation spottings to the nearest whole number and deviation refinement corrections to the nearest 10 meters.

5-77. After the impact phase of a registration, the observer transmits refinement data to the FDC (for example, **LEFT 20, DROP 10**). Normally the observer commands **RECORD AS REGISTRATION POINT**. However, since artillery computer system uses only known points, the observer may be required to transmit **RECORD AS KNOWN POINT**. In either case, the FDC must send a message to observer (MTO) assigning a known point number to the registration point.

**Example**

Impact Registration (see figure 5-10 on page 5-18)

Round	Spotting
4	+6R
5	-8R
6	-5R
7	+7R

Sum of deviations is  $6R + 8R + 5R + 7R = 26R$ . Average deviation is  $26R \div 4$  rounds =  $6.5R \approx 6R$ . Observer-target factor is 3.

Mean point of impact is  $3 \times 6R = 18$  meters R  $\approx 20$  meters R.

Correction is **LEFT 20, DROP 10, RECORD AS REGISTRATION POINT, END OF MISSION, OVER.**

**Example**

Impact Registration

Round	Spotting
1	Target
2	+7R
3	-3L

Sum of deviations is  $0 + 7R + 3L = 4R$ .

Average deviation is  $4R \div 3$  rounds =  $1.33R \approx 1R$ . Observer-target factor is 2.

Mean point of impact is  $2 \times 1R = 2$  meters R  $\approx 0$  (no deviation correction).

Correction is **ADD 10, RECORD AS REGISTRATION POINT, END OF MISSION, OVER.**

**MORTAR REGISTRATION**

5-78. Mortar registration procedures are identical to the impact registration procedures for artillery. The exception is that once a 100 meter range bracket has been split and the last round fired is within 50 meters of the target, the observer sends refinement corrections to the FDC and ends the mission. Make range corrections to the nearest 25 meters. Only one round over and one round short are required. Figure 5-11 (on page 5-20) shows an example of the last two transmissions to the FDC.



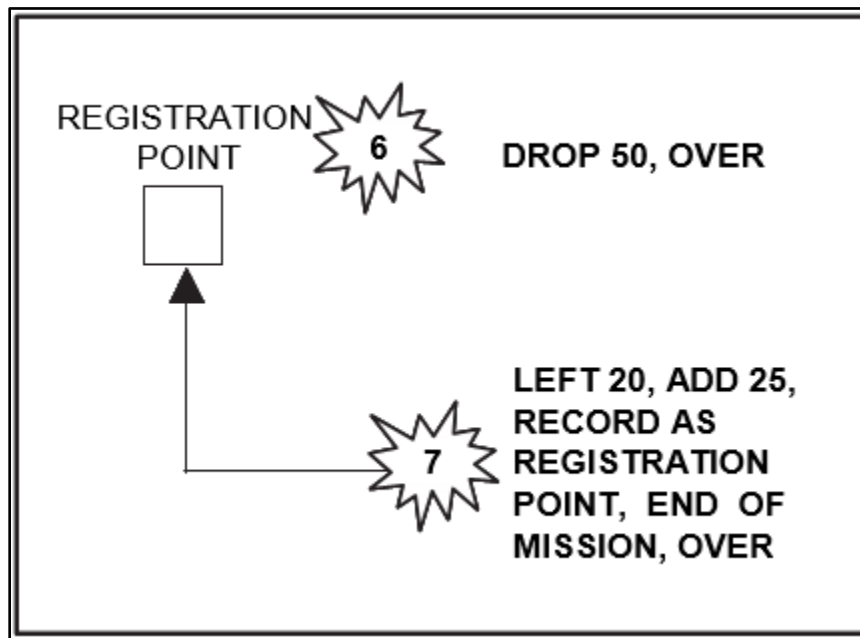

Figure 5-12. Mortar registration

### Adjusting the Sheaf for Mortars

5-79. One additional step that is not required for artillery but may be required for mortars is adjusting the sheaf. Adjusting the sheaf may occur anytime during a fire mission or the FDC may direct it after a registration. If so, the FDC will send **PREPARE TO ADJUST THE SHEAF, OVER**. The purpose of adjusting the sheaf is to get all mortars firing parallel. Mortars are positioned with tubes numbered (for example, one through four for an 81-mm platoon) from right to left as seen from behind the tubes. If a mortar platoon has six tubes, the tubes will be numbered one through six when employed as a platoon or one through three when employed by sections.

5-80. To start adjustment of the sheaf, the observer requests **SECTION RIGHT (or LEFT) REPEAT, OVER**. The method of fire is determined based on the wind direction. If there is a left cross wind, then the observer would direct **SECTION RIGHT REPEAT, OVER**. The purpose of this is so that the subsequent rounds are not obscured by dust blowing from the previous explosions. (Figure 5-13 on page 5-22) for a 120-mm section, numbers one and three will fire (in that order). (Number two conducted the registration.)

5-81. To adjust the sheaf, all rounds must be adjusted on line at approximately the same range (within 50 meters) and with 40 meters lateral spread between rounds. In adjusting the sheaf, ignore range corrections for rounds impacting within 50 meters of the sheaf. The sheaf is adjusted perpendicular to the gun-target line. (If angle T is greater than 500 mils, adjust each piece onto the registration point. The FDC computes data for the sheaf.) Make lateral refinement corrections to the nearest 10 meters, but do not fire corrections of less than 50 meters. Once refinement corrections for all mortars have been determined, adjust the sheaf. Figure 5-12 shows an adjusted sheaf for an 81-mm section.

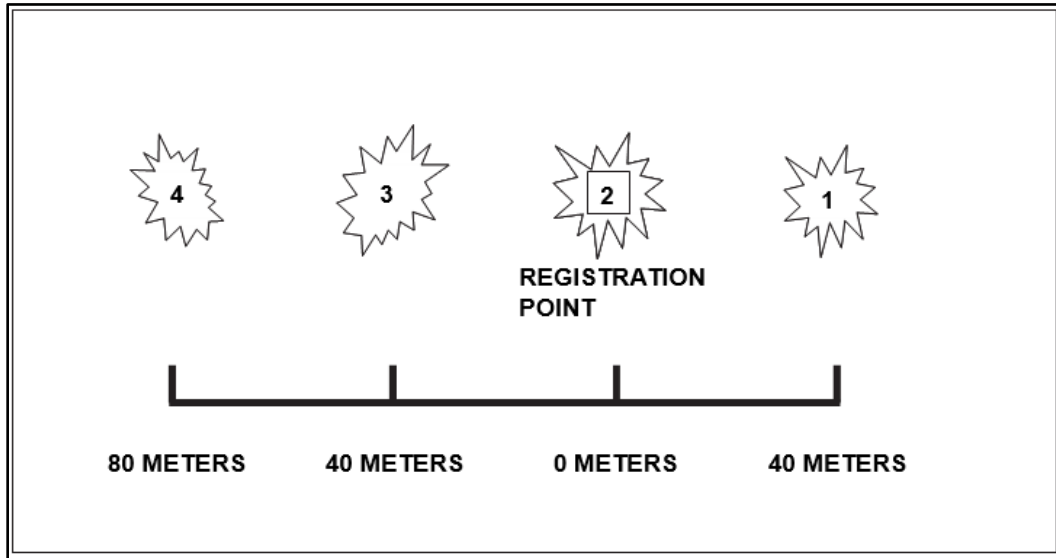

Figure 5-13. Adjusting mortar sheaf

### Example

The observer is adjusting the sheaf of an 81-mm section. Number 2 conducted the registration. The observer has requested **SECTION RIGHT, REPEAT, OVER**. The rounds fired impact as shown in figure 5-13.

All rounds are within 50 meters of the correct range. Only number 3 is more than 50 meters out in lateral adjustment, so send the adjustment for number 3 first. Then send the refinement data for numbers 1 and 4: **NUMBER 3, RIGHT 60, REPEAT; NUMBER 1, RIGHT 30, NUMBER 1 IS ADJUSTED; NUMBER 4, LEFT 20, NUMBER 4 IS ADJUSTED OVER.**

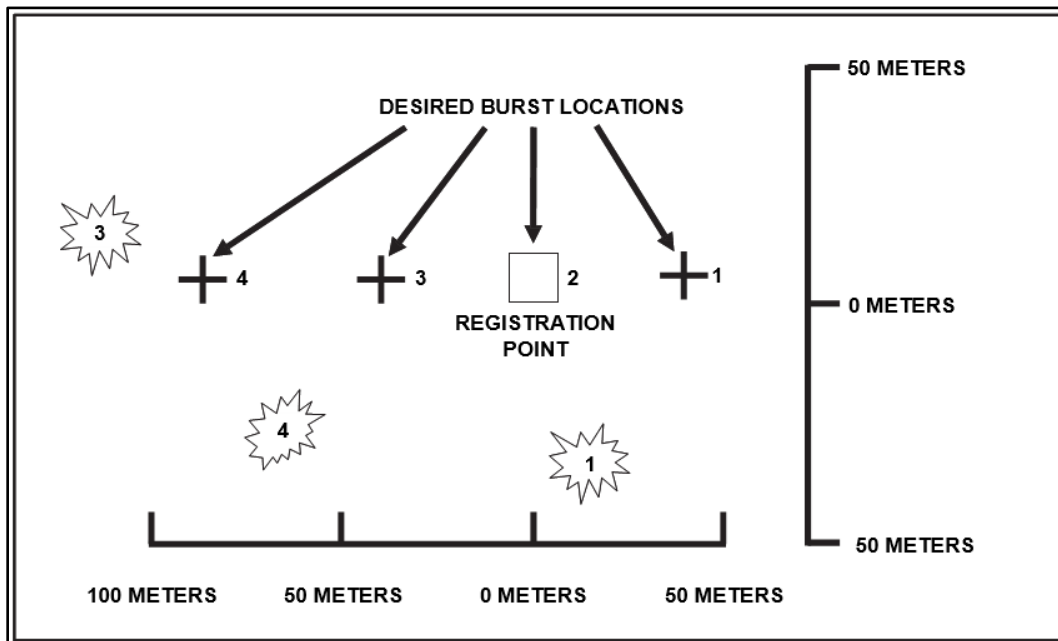

Figure 5-14. Section right, repeat

### Example

Number 3 is now fired and the round impacts 10 meters right of the desired burst location as indicated in figure 5-14. The observer then sends **NUMBER 3, LEFT 10, NUMBER 3 IS ADJUSTED, SHEAF IS ADJUSTED, END OF MISSION, OVER.**

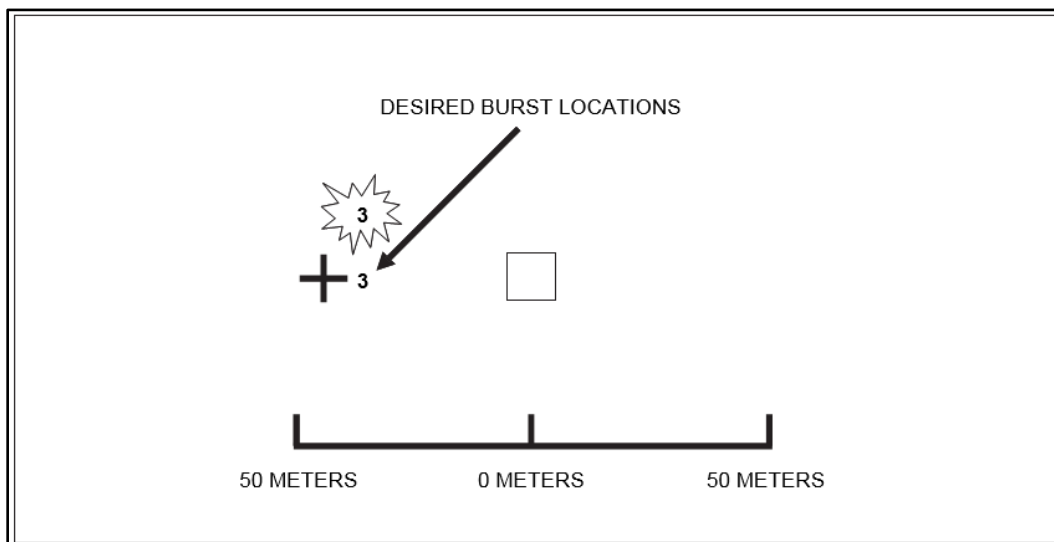

Figure 5-15. Number three is adjusted

### Mortar Registration Point Location Considerations

5-82. The following criteria should be considered when selecting a mortar registration point:

- Facilitate future operations.
- Anticipate the maximum range the mortar will fire.
- Transfer limits of the mortar. According to TC 3-22.91, registration corrections can be applied.
- 1,500 meters beyond and short of the registration point and 400 mils left and right of the weapon location. In most cases, the preferred registration point location can be determined by subtracting 1,500 meters from the maximum range of the mortar or the maximum range the weapon is expected to fire.
- Registration point location is clear of personnel, is semi-permanent, on level terrain and easily identifiable. Also consider whether the area will support an observation post to conduct the registration.
- The registration point is accurately located (nearest 10 meters).

### TIME REGISTRATION

5-83. If a time registration is required after the impact registration has been completed, the observer determines and announces refinement data and commands the time registration to be fired; for example, **RIGHT 10, ADD 10, RECORD AS REGISTRATION POINT, TIME, REPEAT, OVER.**

---

*Note.* Mortars do not conduct time registrations. Mortar mechanical time fuze are typically used with illumination rounds.

---

5-84. The objective of the time portion of the precision registration is to correct the mean HOB of four rounds fired with the same data to 20 meters above the registration point. If the first round is a graze burst, a correction of **UP 40** is given. Once the observer achieves a measurable airburst, the command is **3 ROUNDS REPEAT**. After firing four rounds with the same data, end the registration with the appropriate correction to achieve a 20 meter HOB.

5-85. When four airbursts are spotted, correct the HOB to 20 meters. Determine the mean HOB by adding the four spottings (in mils), dividing by 4, expressing the sum to the nearest mil, and then multiplying by the observer-target factor. (This is the same technique used in determining deviation corrections.) The sum is then expressed to the nearest 5 meters and the appropriate correction is determined to achieve the desired 20 meter HOB; for example, **UP 10, RECORD AS TIME REGISTRATION POINT, END OF MISSION, OVER**.

5-86. When three airbursts and one graze burst are spotted, the HOB is correct. No correction is required.

5-87. With two airbursts and two graze bursts, the HOB correction sent is **UP 10**.

5-88. With one airburst and three graze bursts, the HOB correction sent is **UP 20**.

5-89. It is a good idea to fire check rounds to verify the validity of the time registration; however, it is not mandatory. If the first airburst is extremely high, the observer may make a down correction and fire one round. If that round is at a measurable HOB, the observer can then fire the additional three rounds. Quick and time registration examples are (figures 5-15 through 5-17 on pages 5-24 through 5-27):

CONDUCT OF FIRE					
For use of this form, see ATP 3-09.30; the proponent agency is TRADOC.					
SECTION I - CALL FOR FIRE					
1. OBSERVER Foxtrot 54	2. AF/FFE/IS/S FFE	3. TARGET AA1000	4. GRID 14SNV12345678		
5. POLAR: DIRECTION 2604	6. POLAR: DISTANCE 3300	7. POLAR: UP/DOWN N/A	8. POLAR: VERTICAL ANGLE N/A		
9. SHIFT N/A	10. DIRECTION 2604	11. LEFT/RIGHT Left 20	12. +/- -10	13. UP/DOWN N/A	
14. DESCRIPTION OF TARGET Truck in the open			15. METHOD OF ENGAGEMENT Improved Conventional Munitions (ICM)		
16. AMMUNITION/FUZE 155mm/VT			17. CONTROL At my Command (AMC)		
18. DIRECTION 2604	19. OT FACTOR 3	20. MESSAGE TO OBSERVER 2 rounds, Bravo Btry, Target Number AA 1000			
CORRECTIONS <i>a</i>			SPOTTINGS <i>b</i>	ROUNDS <i>c</i>	REMARKS <i>d</i>
DEVIATION	DISTANCE INITIAL ROUND	HEIGHT OF BURST			
+200	3500	UP 10	+10L	1	N/A
-100	3400		-8R	2	N/A
+50	3450		+5R	3	N/A
-25	3400		-5R	4	N/A
-25	3400		+6R	5	N/A
+25	3400		-1L	6	N/A
+25	3300		-4R	7	N/A
			+2R	8	
			REC AS REG PT		
			A5	9	
			A6	10	
			A5	11	
			REC AS TI REG PT	EOM	

DA FORM 5429, SEP 2017 PREVIOUS EDITIONS ARE OBSOLETE. Page 1 of 2 AFOLC v1.03

A	air	EOM	end of mission
KNPT	known point	L	left
R	right	OT	observer target
Q	fuze quick	REC	record
REG	registration	REG PT	registration point
TI	fuze time		

Figure 5-16. Quick and time registration example, page 1

SECTION II - REGISTRATION																																																																	
21. MESSAGE TO OBSERVER	22. OT DIRECTION	23. OT FACTOR																																																															
REG ON KNPTI, Q & TI	2604	3																																																															
<p>Diagram description: A vertical line labeled 'OT LINE' starts from an 'OBSERVER' at the bottom. The line is annotated with corrections: +100, -200, +90, -25, +25, -400, +25. Numbered starburst symbols (1-12) represent rounds. A large 'SAMPLE' watermark is overlaid on the diagram.</p>	<table border="1"> <thead> <tr> <th>CORRECTIONS <i>e</i></th> <th>SPOTTINGS <i>f</i></th> <th>ROUNDS <i>g</i></th> </tr> </thead> <tbody> <tr> <td>INITIAL ROUND</td> <td></td> <td></td> </tr> <tr> <td></td> <td>+10L</td> <td>1</td> </tr> <tr> <td>R30 -400</td> <td>-8R</td> <td>2</td> </tr> <tr> <td>+200</td> <td>+5R</td> <td>3</td> </tr> <tr> <td>-100</td> <td>-5R</td> <td>4</td> </tr> <tr> <td>-50</td> <td>+6R</td> <td>5</td> </tr> <tr> <td>-25 (2)</td> <td>-L N</td> <td>6</td> </tr> <tr> <td></td> <td>-4R</td> <td>7</td> </tr> <tr> <td>+25 (1)</td> <td>+2R</td> <td>8</td> </tr> <tr> <td colspan="3">L10 -20, REC AS REG PT,</td> </tr> <tr> <td>TI RPT</td> <td>A5</td> <td>9</td> </tr> <tr> <td>3 RPT (3)</td> <td>A6</td> <td>10</td> </tr> <tr> <td></td> <td>A3</td> <td>11</td> </tr> <tr> <td></td> <td>A5</td> <td>12</td> </tr> <tr> <td colspan="2">UP5, REC AS TI REG PT,</td> <td>EOM</td> </tr> <tr> <td></td> <td></td> <td></td> </tr> <tr> <td></td> <td></td> <td></td> </tr> <tr> <td></td> <td></td> <td></td> </tr> <tr> <td></td> <td></td> <td></td> </tr> <tr> <td></td> <td></td> <td></td> </tr> </tbody> </table>	CORRECTIONS <i>e</i>	SPOTTINGS <i>f</i>	ROUNDS <i>g</i>	INITIAL ROUND				+10L	1	R30 -400	-8R	2	+200	+5R	3	-100	-5R	4	-50	+6R	5	-25 (2)	-L N	6		-4R	7	+25 (1)	+2R	8	L10 -20, REC AS REG PT,			TI RPT	A5	9	3 RPT (3)	A6	10		A3	11		A5	12	UP5, REC AS TI REG PT,		EOM																
	CORRECTIONS <i>e</i>	SPOTTINGS <i>f</i>	ROUNDS <i>g</i>																																																														
	INITIAL ROUND																																																																
		+10L	1																																																														
	R30 -400	-8R	2																																																														
	+200	+5R	3																																																														
	-100	-5R	4																																																														
	-50	+6R	5																																																														
	-25 (2)	-L N	6																																																														
		-4R	7																																																														
	+25 (1)	+2R	8																																																														
	L10 -20, REC AS REG PT,																																																																
TI RPT	A5	9																																																															
3 RPT (3)	A6	10																																																															
	A3	11																																																															
	A5	12																																																															
UP5, REC AS TI REG PT,		EOM																																																															
DA FORM 5429, SEP 2017 <span style="float: right;">Page 2 of 2 APO LC v1.00</span>																																																																	
<p>A air</p> <p>KNPT known point</p> <p>R right</p> <p>Q fuze quick</p> <p>REG registration</p> <p>TI fuze time</p>	<p>EOM end of mission</p> <p>L left</p> <p>OT observer target</p> <p>REC record</p> <p>REG PT registration point</p>																																																																

Figure 5-17. Quick and time registration example, page 2

CONDUCT OF FIRE					
For use of this form, see ATP 3-09.30; the proponent agency is TRADOC.					
SECTION I - CALL FOR FIRE					
1. OBSERVER Foxtrot 54	2. AF/FFE/IS/S FFE	3. TARGET AA1000	4. GRID 14SNV12345678		
5. POLAR: DIRECTION 2880	6. POLAR: DISTANCE 3300	7. POLAR: UP/DOWN N/A	8. POLAR: VERTICAL ANGLE N/A		
9. SHIFT N/A	10. DIRECTION 2880	11. LEFT/RIGHT Left 20	12. +/- -10	13. UP/DOWN N/A	
14. DESCRIPTION OF TARGET Truck in the open			15. METHOD OF ENGAGEMENT Improved Conventional Munitions (ICM)		
16. AMMUNITION/FUZE 155mm/VT			17. CONTROL At my Command (AMC)		
18. DIRECTION 2880	19. OT FACTOR 3	20. MESSAGE TO OBSERVER 2 rounds, Bravo Btry, Target Number AA1000			
CORRECTIONS a			SPOTTINGS b	ROUNDS c	REMARKS d
DEVIATION	DISTANCE INITIAL ROUND	HEIGHT OF BURST			
			-10	1	N/A
+200	3400		+2R	2	N/A
100	3450		-4L	3	N/A
+50	3400		+1R	4	N/A
-25	3450		-3L	5	N/A
			RCL2L	6	N/A
			REC AS REG PT,	TI RPT	N/A
			A7	7	N/A
RPT			A4	8	N/A
			G	10	N/A
			REC AS A TI REG PT	EOM	
DA FORM 5429, SEP 2017					
PREVIOUS EDITIONS ARE OBSOLETE.					
Page 1 of 2 AFD LC v1.00					
A	air	EOM		end of mission	
KNPT	known point	L		left	
R	right	OT		observer target	
Q	fuze quick	REC		record	
REG	registration	REG PT		registration point	
TI	fuze time				

Figure 5-18. Quick and time registration-range correct spotting example, page 1



### Example

Quick and time registration (see figure 5-15 on page 5-24).

Refinement data for the impact portion was determined by using rounds 5, 6, 7, and 8.

Sum of deviation spottings is  $6R + 0 + 4R + 2R = 12R$ .

Average deviation is  $12R \div 4 = 3R$ . Observer-target factor is 3.

Mean point of impact is  $3 \times 3R = 9$  meters  $R \approx 10$  meters  $R$ .

The registration point is nearer the pair of rounds at the opposite end of the bracket from the last round fired.

Correction is **LEFT 10, DROP 20, RECORD AS REGISTRATION POINT, TIME REPEAT, OVER.**

Refinement data for the time portion was determined by using rounds 9, 10, 11, and 12.

The sum of HOB spottings is:

$AIR 5 + AIR 6 + AIR 3 + AIR 5 = AIR 19$ .

Average HOB is  $AIR 19 \div 4 = AIR 4.75 \approx AIR 5$ . Observer-target factor is 3.

Mean HOB is  $3 \times AIR 5 = AIR 15$  meters.

Correction is **UP 5, RECORD AS TIME REGISTRATION POINT, END OF MISSION, OVER.**

SECTION II - REGISTRATION			
21. MESSAGE TO OBSERVER REG ON KN PT1, Q & TI	22. OT DIRECTION 2880	23. OT FACTOR 3	
	CORRECTIONS <i>e</i>	SPOTTINGS <i>f</i>	
	INITIAL ROUND	ROUNDS <i>g</i>	
		-10L	①
	R30 +200	+2R	②
	-100	-4L	③
	+50	+1R	④
	-25	-3L	⑤
		RCL 2L	⑥
	REC AS REG PT,	TI RPT	
	RPT	A7	⑦
	A4	⑧	
	G	⑨	
	A3	⑩	
	REC AS REG PT,	EOM	

DA FORM 5429, SEP 2017 Page 2 of 2  
AFD LG v1.00

A	air	EOM	end of mission
KNPT	known point	L	left
R	right	OT	observer target
Q	fuze quick	REC	record
REG	registration	REG PT	registration point
TI	fuze time		

Figure 5-19. Quick and time registration-range correct spotting example, page 2

CONDUCT OF FIRE						
For use of this form, see ATP 3-09.30; the proponent agency is TRADOC.						
SECTION I - CALL FOR FIRE						
1. OBSERVER Foxtrot 54	2. AF/FFE/IS/S FFE	3. TARGET AA1000	4. GRID 14SNV12345678			
5. POLAR: DIRECTION 1330	6. POLAR: DISTANCE 3300	7. POLAR: UP/DOWN N/A	8. POLAR: VERTICAL ANGLE N/A			
9. SHIFT N/A	10. DIRECTION 1330	11. LEFT/RIGHT Left 20	12. +/- -10	13. UP/DOWN N/A		
14. DESCRIPTION OF TARGET Truck in the open			15. METHOD OF ENGAGEMENT Improved Conventional Munitions (ICM)			
16. AMMUNITION/FUZE 155mm/VT			17. CONTROL At my Command (AMC)			
18. DIRECTION 1330	19. OT FACTOR 4	20. MESSAGE TO OBSERVER 2 rounds, Bravo Btry, Target Number AA1000				
CORRECTIONS <i>a</i>			SPOTTINGS <i>b</i>		ROUNDS <i>c</i>	REMARKS <i>d</i>
DEVIATION	DISTANCE INITIAL ROUND	HEIGHT OF BURST				
			+7R		1	N/A
-400	3400		-4L		2	N/A
+200	3450		+3R		3	N/A
-100	3400		-4R		4	N/A
+50	3450		+LN		5	N/A
-25	3500		+1L		6	N/A
			+5R		7	N/A
-25	3450		-1R		8	N/A
TI RPT	3400		A7		9	N/A
			G		10	N/A
			G		11	N/A
			A5		12	N/A
REC AS A TI REG PT,					EOM	
DA FORM 5429, SEP 2017			PREVIOUS EDITIONS ARE OBSOLETE.			Page 1 of 2 AFD-LC-v1.00
A	air		EOM	end of mission		
KNPT	known point		L	left		
R	right		OT	observer target		
Q	fuze quick		REC	record		
REG	registration		REG PT	registration point		
TI	fuze time					

Figure 5-20. Quick and time registration during adjustment example, page 1

### Example

Quick and time registration—range correct spotting (see figure 5-16 on page 5-26). Refinement data for the impact portion was determined by using rounds 4, 5, and 6. Sum of deviation spottings is  $1R + 3L + 2L = 4L$ . Average deviation is  $4L \div 3 = 1.33L \approx 1L$ . Observer-target factor is 3. MPI is  $3 \times 1L = 3$  meters  $L \approx 0$  meters. The registration point is nearer the last round fired. Correction is **RECORD AS REGISTRATION POINT, TIME 1 ROUND, REPEAT, OVER.** (The change in the volume of fire to one round is required because the previous correction had changed the method of engagement to two rounds.) Refinement data for the time portion was determined by using rounds 7, 8, 9, and 10. The time portion spottings were 3 AIR and 1 GRAZE. Correction is **RECORD AS TIME REGISTRATION POINT, END OF MISSION, OVER.**

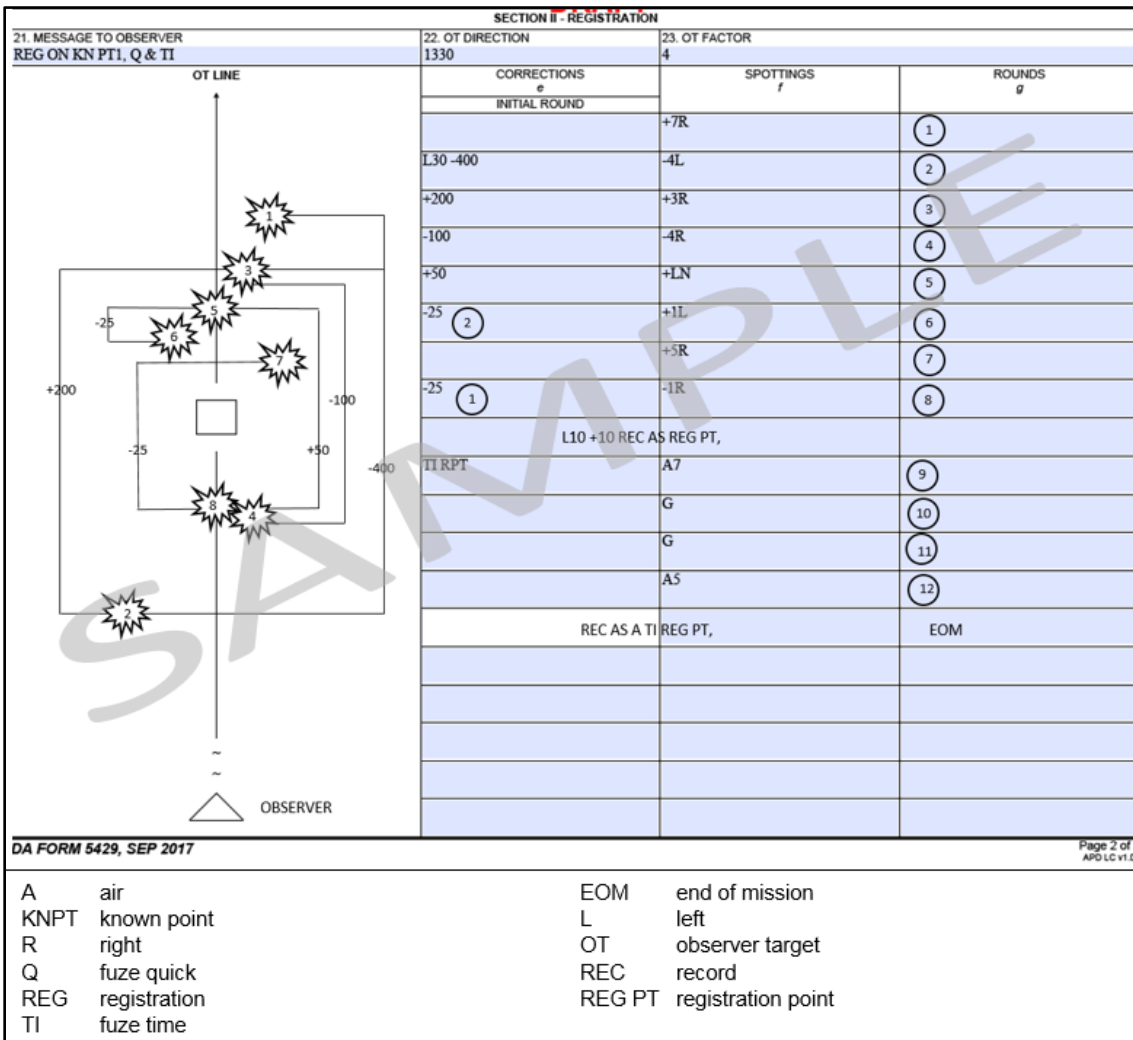

Figure 5-21. Quick and time registration during adjustment example, page 2

### Example

Quick and time registration during adjustment (see figure 5-17 on page 5-27).  
Refinement data for the impact portion was determined by using rounds 4, 6, 7, and 8.

Sum of deviation spottings is  $4R + 1L + 5R + 1R = 9R$ .

Average deviation is  $9R \div 4 = 2.25R \approx 2R$ . Observer-target factor is 4.

MPI is  $4 \times 2R = 3$  meters  $L \approx 8$  meters  $R \approx 10$  meters  $R$ .

The registration point is equidistant between the two pairs of rounds.

Correction is **LEFT 10, ADD 10, RECORD AS REGISTRATION POINT, TIME REPEAT, OVER.**

Refinement data for the time portion was determined by using rounds 9, 10, 11, and 12.

The spottings were 2 AIR and 2 GRAZE.

Correction is **UP 10, RECORD AS TIME REGISTRATION POINT, END OF MISSION, OVER.**

## SECOND LOT REGISTRATIONS

5-90. Conduct second lot registrations in much the same manner as first lot (single) registrations. After completing the first lot impact registration, conduct a time registration, if required. The FDC must announce to the observer **OBSERVE SECOND LOT REGISTRATION** (see table 5-5). The observer must reestablish the appropriate range bracket and complete the second lot registration by using the same procedures as for the first lot. Do not fire the time portion of the second lot registration.

**Table 5-5. Registration with two lots**

<i>Observer</i>	<i>Fire Direction Center</i>
	H18 THIS IS H44, REGISTER ON KNOWN POINT 2, QUICK AND TIME, 2 LOTS, OVER.
THIS IS H18, REGISTER ON KNOWN POINT 2, QUICK AND TIME, 2 LOTS, OUT.	
<b>AT COMPLETION OF FIRST LOT REGISTRATION</b>	
RECORD AS TIME REGISTRATION POINT, OVER.	
	RECORD AS TIME REGISTRATION POINT, OUT.
	OBSERVE SECOND LOT REGISTRATION, OVER.
OBSERVE SECOND LOT REGISTRATION, OUT.	

## ABBREVIATED REGISTRATION

5-91. At times, the tactical situation or ammunition constraints may prohibit conduct of a full scale registration. Although not as accurate, an abbreviated registration (see figure 5-18 on page 5-29) can provide adequate corrections for the effects of nonstandard conditions. The decision to conduct an abbreviated registration rests with the fire direction officer. For this type of registration, the observer merely shortens the standard procedures.

CONDUCT OF FIRE						
For use of this form, see ATP 3-09.30; the proponent agency is TRADOC.						
SECTION I - CALL FOR FIRE						
1. OBSERVER	2. AF/FFE/IS/IS	3. TARGET	4. GRID			
Foxtrot 54	FFE	AA1000	14SNV12345678			
5. POLAR DIRECTION	6. POLAR DISTANCE	7. POLAR UP/DOWN	8. POLAR VERTICAL ANGLE			
0220	3300	N/A	N/A			
9. SHIFT	10. DIRECTION	11. LEFT/RIGHT	12. +/-	13. UP/DOWN		
N/A	2604	Left 20	-10	N/A		
14. DESCRIPTION OF TARGET			15. METHOD OF ENGAGEMENT			
Truck in the open			Improved Conventional Munitions (ICM)			
16. AMMUNITION/FUZE			17. CONTROL			
155mm VT			At my Command (AMC)			
18. DIRECTION	19. OT FACTOR	20. MESSAGE TO OBSERVER				
0220	3	2 rounds, Bravo Btry, Target Number AA 1000				
CORRECTIONS <i>a</i>			SPOTTINGS <i>b</i>		ROUNDS <i>c</i>	REMARKS <i>d</i>
DEVIATION	DISTANCE INITIAL ROUND	HEIGHT OF BURST				
+200	3500		+3R		1	N/A
-100	3400		-2R		2	N/A
+50	3450		+3R		3	N/A
-25	3400		-3R		4	N/A
N/A	N/A		REC AS REG PT TI RPT			N/A
+25	3400		G		5	N/A
+25	3300		A3		6	N/A
		UP10	REC AS TI REG PT		EOM	
<b>DA FORM 5429, SEP 2017</b> <span style="float: right;">PREVIOUS EDITIONS ARE OBSOLETE. <small>Page 1 of 2 APD LC v1.00</small></span>						
A	air	EOM		end of mission		
KNPT	known point	L		left		
R	right	OT		observer target		
Q	fuze quick	REC		record		
REG	registration	REG PT		registration point		
TI	fuze time					

Figure 5-22. Abbreviated registration example, page 1

SECTION II - REGISTRATION		
21. MESSAGE TO OBSERVER REG ON KN PT, Q & TI	22. OT DIRECTION 0220	23. OT FACTOR 3
	CORRECTIONS <i>g</i>	SPOTTINGS <i>f</i>
	INITIAL ROUND	ROUNDS <i>g</i>
	R30 -400	+3R (1)
	+200	-2R (2)
	-100	+3R (3)
	-50	-3R (4)
	2 -25	RECORD AS REG PT, TI RPT (5)
	UP40	A3 (6)
UP10	RECORD AS TI REG POINT	EOM

DA FORM 5429, SEP 2017 Page 2 of 2  
APO LC v1.00

A	air	EOM	end of mission
KNPT	known point	L	left
R	right	OT	observer target
Q	fuze quick	REC	record
REG	registration	REG PT	registration point
TI	fuze time		

**Figure 5-23. Abbreviated registration example, page 2**

5-92. Follow normal adjust fire procedures until a 100 meter bracket is split.

5-93. Then send the correction **ADD** (or **DROP**) **50 METERS**.

5-94. Spot the resulting burst, and send minor corrections for deviation and range to the FDC in the following format:

- For impact and time portion of registrations: **LEFT 10, DROP 40, RECORD AS REGISTRATION POINT, TIME, REPEAT, OVER.**
- For an impact only registration: **RIGHT 30, DROP 10, RECORD AS REGISTRATION POINT, END OF MISSION, OVER.**

5-95. Normal adjust fire, time adjustment procedures are followed in the time portion:

- Obtain an airburst and correct to a 20 meter HOB.
- Instead of firing additional rounds, send refinement the FDC in the following format: **UP 10, RECORD AS TIME REGISTRATION POINT, END OF MISSION, OVER.**

5-96. Abbreviated registrations are much more accurate and therefore more feasible if the observer is equipped with a laser rangefinder.

## DESTRUCTION MISSION

5-97. Use a precision-guided munition such as Excalibur or Hellfire to destroy a well located point target. If these are not available, area munitions, such as HE, may be used. If using only area munitions, fire one weapon to destroy a point target. The mission is similar to a registration in that the observer continues adjustments to establish a 25 meter bracket. Once it is established, the observer splits the 25 meter bracket by adding or dropping 10 meters and continues to fire additional rounds. After every third round, make an additional refinement, and then continue firing until the target is destroyed or the mission is ended. (The observer may make corrections after each round.) For example, the observer makes the refinement as shown in figure 5-19.

5-98. Because of the amount of time and ammunition required, avoid destruction missions using only area munitions. Only a target that is critical to an operation should be engaged in this manner, and only if no other means, such as precision munitions, exists to destroy the target.

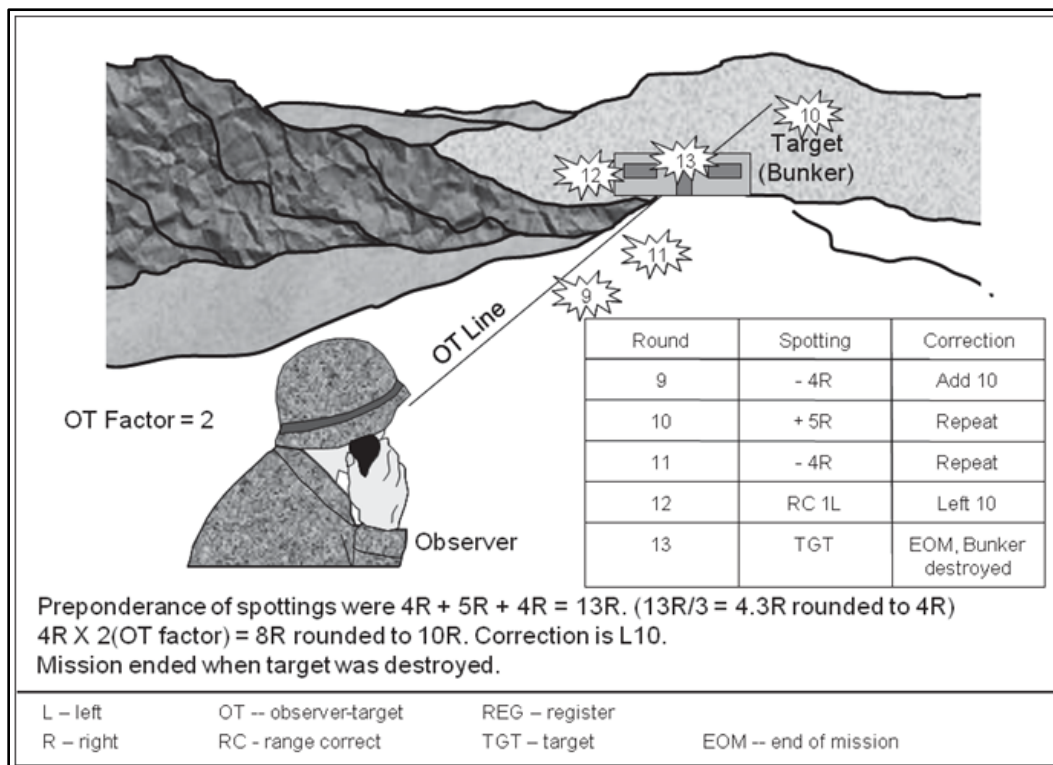

Figure 5-24. Destruction mission

## HIGH-BURST OR MEAN POINT OF IMPACT REGISTRATION

5-99. The opportunities for a registration are limited, therefore the observer may be called upon to perform it because it requires visual observation on a clearly defined, accurately located registration point in the target area. At night, visual adjustment of fire on a registration point is impossible without some type of illumination or night observation device. In desert, jungle, or arctic operations, clearly defined registration points in the target area are not usually available. Special procedures, including special observation techniques, provide for registration under these conditions. Two such procedures are the high-burst and mean point of impact registration.



5-100. For the high-burst registration, two observers (referred to as O1 and O2) simultaneously observe time fire aimed at a point in the air above the target. The FDC selects the point to observe. It does this by selecting the desired point of impact on the ground and projecting this point into the air with a prescribed HOB. The FDC controls the firing of the high-burst registration. The unit fires the registration with a single weapon firing the same data for all the rounds. Each observer, using an aiming circle or a laser designator and rangefinder reports the direction from their positions to the bursts. One observer reports the vertical angle after each round. An MPI registration is the same except the fuze used is fuze quick.

### LOCATION AND INITIAL ORIENTATION OF THE OBSERVING INSTRUMENTS

5-101. In a high-burst registration, the accurate location of each observation post and the proper orientation of each observing instrument are very important. Each observation post location is surveyed and a line of known direction is established on the ground so that the observer can orient the instrument for direction. If possible, the observer should establish the observation post and orient the instrument for direction during daylight. However, the exact location of the instrument and the line of known direction should be marked for easy identification during darkness. These precautions allow the observer to position and orient the instrument during darkness if necessary. To establish the observation post, the observer sets the instrument over the position marker, makes sure that the instrument is level, and then orients the instrument on the line of known direction. The observer sets the azimuth of the line of known direction on the azimuth scales of the instrument by using the upper recording motion. Then, using the lower motion, the observer aligns the reticle vertical centerline on the marker or the point that identifies the known direction. If using a laser, the observer places the vertical reticle edge on the known direction marker and uses the azimuth knob to put the known direction on the display. Once completed, the instrument is oriented for direction.

### ORIENTATION OF THE OBSERVING INSTRUMENTS ON THE ORIENTING POINT

5-102. The FDC tells each observer the direction and vertical angle from their positions to the orienting point. The example below is a typical message from the FDC to the observers.

#### Example

**H18 THIS IS H44, OBSERVE HIGH-BURST REGISTRATION, OBSERVER 1 DIRECTION 1164, VERTICAL ANGLE PLUS 12, MEASURE THE VERTICAL ANGLE. OBSERVER 2 DIRECTION 0718, VERTICAL ANGLE MINUS 3. REPORT WHEN READY TO OBSERVE, OVER.**

5-103. Each observer, using the upper motion, sets the direction given on the azimuth scales of the instrument. The horizontal line of sight of the instrument now coincides with the horizontal line of sight from the observer's position to the orienting point. Each observer also sets the vertical angle given on the elevation scales of the instrument to orient the instrument for HOB. The manner in which the observer sets the vertical angle on the scales of the instrument depends on the type of instrument being used.

5-104. The elevation scales on the M2 aiming circle are graduated so that a 0 reading on the scales corresponds to a vertical angle of 0. The scales are graduated and numbered in each direction from 0. The graduations and numbers in one direction from 0 are black; those in the other direction are red. Black numbers indicate positive (plus) vertical angles and red numbers indicate negative (minus) vertical angles. Operate the elevation scales on the aiming circles with the elevation micrometer knob. If the vertical angle given the observer is a negative (minus) angle, and sets its value on the elevation scales in the direction represented by the red numbers. This action places the intersection of the reticle vertical and horizontal centerlines of the instrument in line with the point in the air selected as the orienting point.

## MEASURING AND REPORTING THE FIRST ROUND

5-105. When the observers report **READY TO OBSERVE**, the FDC directs the firing of the rounds one at a time. The FDC reports **SHOT** and **SPLASH** after firing each round. When the burst of the first round appears, each observer determines the direction to the round by spotting the horizontal deviation from the reticle vertical centerline in the reticle of the instrument and then combines this value with the reading on the azimuth scales. If the deviation is to the left of the reticle vertical centerline, subtract the value from the reading on the azimuth scales. If it is to the right of the reticle vertical centerline, add the value to the reading on the reading on the instrument.

### Example

A round bursts 20 mils right of the reticle vertical centerline and the reading on the azimuth scales is 0480. The azimuth to the burst is 0500 ( $0480 + 20 = 0500$ ).

5-106. The vertical angle to the burst is determined as discussed below.

5-107. If using an aiming circle the observer spots the number of mils the burst appears above or below the horizontal centerline in the reticle of the instrument and combines this reading with the reading on the elevation scales.

### Example

The burst appears 10 mils above the reticle horizontal centerline and the reading on the elevation scales is +20. The vertical angle to the burst is +30 ( $20 + 10 = 30$ ).

5-108. The observers report in turn.

### Example

**OBSERVER 1 DIRECTION 0500, VERTICAL ANGLE +30, OVER. OBSERVER 2 DIRECTION 0167, OVER.**

5-109. If the observer does not observe the initial round within the field of view of the instrument, observer should report this, the approximate direction, and vertical angle to where the round burst to the FDC.

### Example

**OBSERVER 2 ROUND UNOBSERVED, TOO FAR LEFT, DIRECTION 0300, VERTICAL ANGLE +25, OVER.**

## REORIENTING ON THE FIRST ROUND

5-110. Once the observer reports the direction (and vertical angle, if applicable) to the first round, the observer reorients the instrument (see figure 5-20) on the direction and vertical angle to where that initial round burst. This allows for smaller deviation measurements for subsequent rounds.

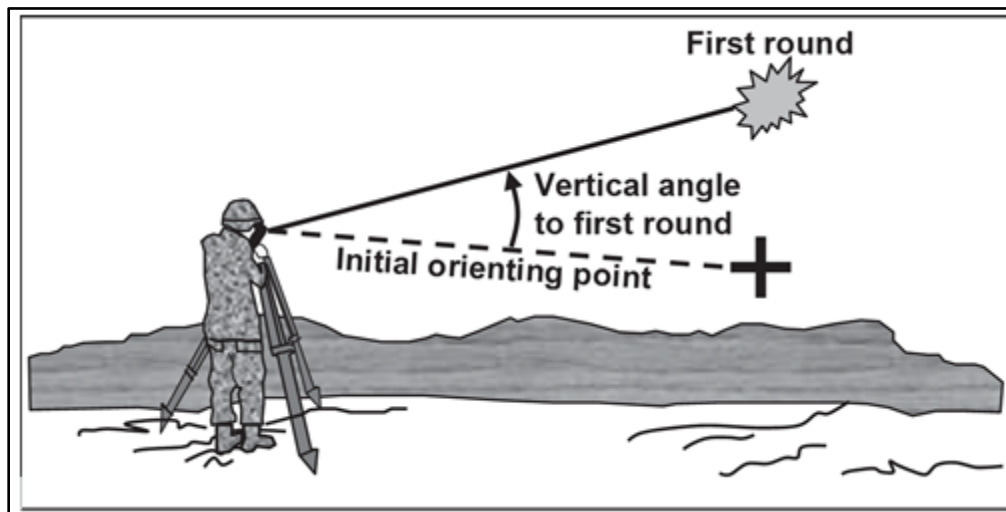

Figure 5-24. Reorientation after the first round

### MEASURING AND REPORTING SUBSEQUENT ROUNDS

5-111. The procedures for measuring and reporting direction and vertical angle for subsequent rounds are the same as those for the first round. However, the observer does not reorient the instrument after subsequent rounds.

### OBSERVER PROCEDURES IN A HIGH-BURST REGISTRATION

5-112. The following example illustrates the observer procedures in the conduct of a high-burst registration. Only observer 1 is discussed.

### Example

Observer 1 arrives at and occupies a position and locates the survey stake that marks the exact location of the instrument. The tag on the survey stake indicates that the azimuth of the known direction is 1,860 mils and that the direction is identified on the ground as the left edge of a red building approximately 1,500 meters to the right flank,

Observer 1 places the aiming circle over the marking stake. With the upper recording motion, the observer sets off an azimuth of 1,860 mils on the azimuth scales. Using the lower motion, the observer aligns the centerlines in the reticle of the instrument on the left edge of the red building. The observer reports to the FDC that he is in position.

Observer 1 receives the following message from the FDC: **OBSERVE HIGH-BURST REGISTRATION, Observer 1 DIRECTION 0430, VERTICAL ANGLE PLUS 15, and MEASURE THE VERTICAL ANGLE.** With the upper motion, Observer 1 turns the azimuth scales to 0430 and sets off +15 on the elevation scales.

Observer 1 reports the following to the FDC: **OBSERVER 1 READY TO OBSERVE.** The FDC sends commands to the weapon to fire the first round. After firing the round, the FDC reports to Observer 1 **SHOT, OVER** and **SPLASH, OVER.** When the first round bursts, Observer 1 observes the burst 40 mils left of the reticle vertical centerline and 5 mils below the reticle horizontal centerline. Since the deviation is to the left of the reticle vertical centerline, Observer 1 subtracts 40 from the setting on the azimuth scales (0430) and obtains a direction of 0390. Since the burst appeared 5 mils below the reticle horizontal centerline, Observer 1 subtracts 5 from the setting on the elevation scales (+15) and obtains a vertical angle of +10.

Observer 1 reports the instrument readings for the first round: **OBSERVER 1 DIRECTION 0390, VERTICAL ANGLE PLUS 10, OVER.**

Observer 1 reorients the aiming circle on a direction of 0390 and a vertical angle of +10, then prepares to measure the deviation of subsequent rounds. The FDC directs the weapon to fire. After firing the second round, the FDC reports to Observer 1 **SHOT, OVER** and **SPLASH, OVER.**

5-113. The procedures for measuring and reporting subsequent rounds are the same as those for the first round, except the observer reads the measurement from the reoriented direction and vertical angle. When the FDC has enough instrument readings to compute the registration data, it terminates the registration by telling observer 1: **OBSERVER 1 END OF MISSION.**

### MEAN POINT OF IMPACT REGISTRATION

5-114. In an MPI registration, the FDC selects a ground location as the orienting point and uses impact fuzes in the registration. The establishment of the observation post and the procedures followed by the observers are the same as those in a high-burst registration. Once both observers have spotted the round, the firing data is not changed. After observing each round, each observer reports the direction to the round and the designated observer also reports the vertical angle. This determines a more accurate target location and altitude than is available from just a map spot.

5-115. Observers must be proficient at engaging moving targets of opportunity and in planning and executing planned fires against targets that will be moving at a future time of attack. In either case, the observer must estimate the direction and speed of the adversary, determine intercept and trigger points, and time the firing so that the rounds and vehicle(s) arrive at the desired location at the same time. This section provides an overview of the general procedures for moving targets, both planned and targets of opportunity.

## TARGET OF OPPORTUNITY

5-116. Often, with a moving target of opportunity the observer must quickly initiate the fire mission to alert the firing unit, while simultaneously estimating the intercept and trigger points. Training, practice, and experience are critical in the execution of fires against moving targets of opportunity as there is little time to complete the task and the pressure is usually intense. Observers should receive regular training in the attack of moving targets of opportunity, in a variety of scenarios and conditions, in order to maintain their skill in this task.

## PLANNED TARGET

5-117. The degree of prearrangement for a planned target may vary, but in each case, some prior coordination or action has been completed to facilitate engagement.

5-118. The procedure for calculating the intercept and trigger points for planned moving targets is basically the same as for engaging targets of opportunity. However, the observer has the opportunity to better select intercept and trigger points better suited to the anticipated situation. In addition to the intercept and trigger points (described below), the observer should determine the points at which the observer can expect to become aware of or receive notification of the moving target, and at which point the observer will be able to observe the target under various conditions (day, night, fog). Understanding the time distance relationships of these various points is critical to the successful planning of fires against moving targets.

5-119. Because accurately predicting the adversaries movement is not always possible, the observer may need to plan multiple intercept and trigger points for a planned moving target. To prevent confusion the observer can plan the mission based on a primary intercept point, then determine and record the shift data necessary to shift the mission from the primary to an alternate intercept point.

5-120. Additionally, the observer should be prepared to execute the mission as a target of opportunity mission, quickly determining new intercept and trigger points if the adversary moves differently than what the observer had planned for.

5-121. Another advantage of planned targets is that the observer may have the opportunity to mark trigger or even intercept points so that they are more visible and identifiable under a variety of battlefield conditions. Marking is discussed later in this section.

## MOVING TARGET CALCULATION

5-122. The following paragraphs outline the basic procedures for calculating the points and data needed to execute fires against moving targets. The procedures described are for attack against a moving target of opportunity, but the observer uses the same basic methodology for planned moving targets.

### DETERMINE TARGET DIRECTION AND SPEED

5-123. After acquiring the target, the observer tracks it until sure of the direction in which it is moving. As the target moves from point A to point B (see Figure 5-21), the observer can use one of four methods to determine its speed.

#### Estimation Method

5-124. First the observer can estimate the speed:

- **Slow**—3 meters per second (7 miles per hour [mph]).
- **Medium**—5 meters per second (11 mph).
- **Fast**—8 meters per second (18 mph).

### Lasing Method

5-125. The observer can use a lasing device to measure the distance the target moves during a certain time interval. As the target moves, the observer lases it and converts the polar data to grid locations for points A and B. Then the observer determines how far the target moved by measuring the distance between points A and B and rounding to the nearest one meter. The observer divides the distance traveled by the time interval between points A and B to determine the target speed in meters per second.

### Reticle Pattern Method

5-126. This method works best when the target is moving across the observer's field of view. The observer can use the reticle pattern in any device with a reticle pattern graduated in mils to measure the distance the target moves during a certain time interval. As the target moves across the reticle pattern, the observer measures the number of mils traveled to the nearest 5 mils, then multiplies that number by the observer-target factor to convert the distance traveled by the target to meters. The observer divides the distance traveled by the time interval to determine the target speed, in meters per second and then rounds to the nearest one meter. The reticle pattern method does not work if the target is moving directly toward or away from the observer

---

*Note.* The observer can also designate, by using a lasing device or binoculars, a distance on the ground, for example, 100 meters, then times how long the target takes to travel that distance and divides that distance by the time interval.

---

### Laser Range Method

5-127. This method works best when the target is moving directly toward or away from the observer. The observer can use a laser rangefinder to determine the range to points A and B. The observer must first determine and record the range to A. When the vehicle reaches point A, the observer tracks the vehicle for a specified time interval. When the time interval has passed, the observer lases the target to determine range (range at point B). Subtracting the smaller range from the larger range will give the distance between A and B. The observer now knows how far the vehicle moves during the specified time interval. The laser range method does not work if the target is moving across the observer's field of view.

### PREDICT THE INTERCEPT POINT

5-128. Once the observer determines the speed and direction of the target, the intercept point (grid) at which to engage the moving target must be predicted (see figure 5-21 on page 5-37). To do this, the observer first gathers and adds the following information:

- Total processing time, in seconds (observer, fires cell, FDC and gun times).
- Time of flight (estimated based on previous fire missions or by request upon establishment of the Observation Post).

5-129. The observer then multiplies that sum by the target speed. The product is the minimum distance to plot the intercept point in front of the moving target in the direction it is traveling. So the target will not pass the intercept point before the round impacts, the observer must plot the intercept point distance well ahead of the moving target to allow enough time to get the grid and prepare the call for fire. Experience dictates how far ahead of the target to plot the intercept point. An inexperienced observer should add to the intercept distance half the distance determined to allow enough time. To simplify plotting, the observer can round up the intercept distance to the nearest 100 meters.

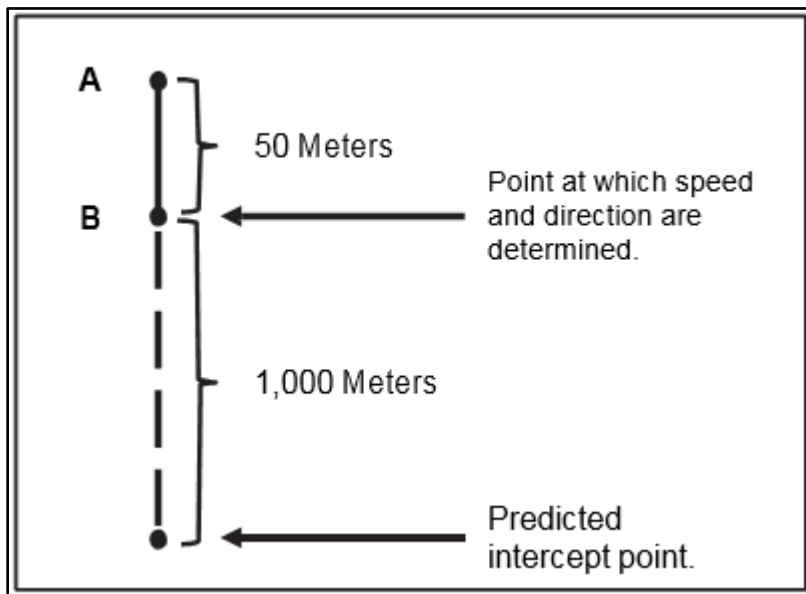

**Figure 5-25. Determining the intercept point**

### Example

(See figure 5-21.) The distance measured between points A and B is 50 meters. The time interval between A and B is 10 seconds. Speed of the target is 50 meters in 10 Seconds, or 5 meters per second. Total processing time is 3 minutes (180 seconds). Time of flight is 20 seconds.

The distance at which to plot the intercept point is 5 meters per second X 200 seconds, or 1,000 meters. The observer must convert minutes to seconds for this procedure to work.

5-130. Given the above example, the intercept point must be at least 1,000 meters in front of the target along the intended path of the target. The method of control should be observer control (at my command). Then use the intercept point grid in the call for fire as the target location.

### DETERMINE THE TRIGGER POINT

5-131. After determining the intercept point and sending the mission to the firing unit, the observer must determine a point at which to command the guns to fire. This point is determined to ensure both the rounds and the target arrive at the intercept point at the same time. When the target passes over or near the trigger point, the observer commands the guns to fire.

5-132. In determining the trigger point, the observer must consider the intended path of the target, target speed, time of flight, and call for fire transmission time.

5-133. The first step is to determine the distance from the planned target location or intercept point to the trigger point. The observer adds the transmission time (an average of 5 seconds) to the time of flight received in the MTO and multiplies this sum by the speed of the target.

### Example

Transmission time is 5 seconds. Time of flight is 20 seconds. Target speed is 5 meters per second. Distance to trigger point = (transmission time + time of flight) X target speed, or (5 seconds + 20 seconds) X 5 meters per second = 125 meters.

5-134. Plot the trigger point by measuring the distance determined above from the planned target location or intercept point along the intended path toward the moving target (see figure 5-22).

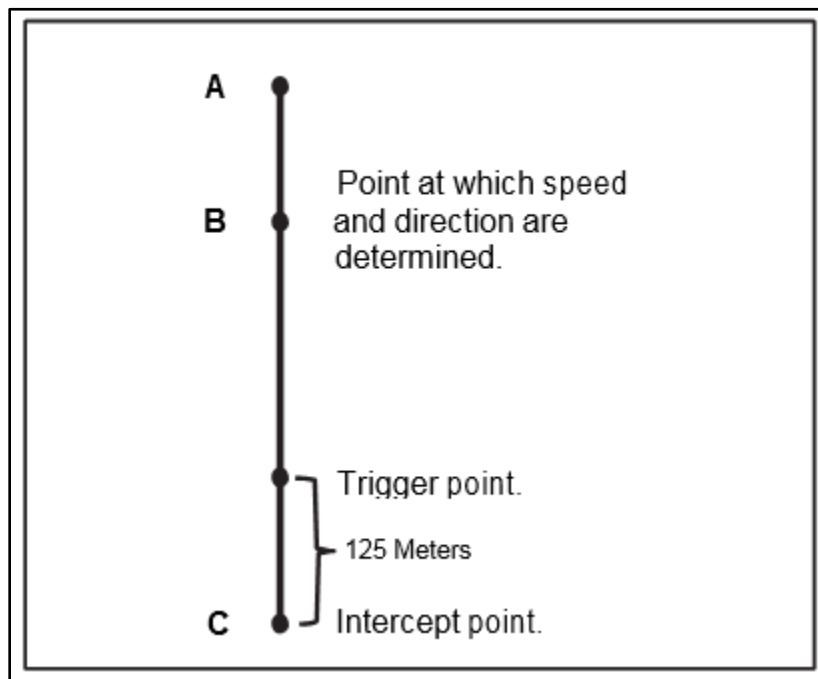

**Figure 5-26. Determining the trigger point**

5-135. If the target passes the trigger point before the battery reports **READY**, the observer should make a bold shift to a new target location by using the same trigger point and intercept distances. Send a grid for the new location to the FDC immediately.

5-136. If the observer does not intend to request **AT MY COMMAND** or **BY ROUND AT MY COMMAND**, the trigger point becomes the point at which the call for fire was initiated. In this case, mission reaction time must be included in determining the distance to the trigger point. This allows time for the mission to be processed and the firing unit to shift onto the target. Normal mission reaction times are:

- Priority targets—30 to 60 seconds (plus time of flight).
- On-call targets—90 to 120 seconds (plus time of flight).
- Targets of opportunity—150 to 180 seconds (plus time of flight).

**Note.** These are ideal averages and will not be applicable to all situations. For targets of opportunity during high tempo operations, the observer or fire planner may need to allow as much as seven minutes in reaction time (from end of mission of a previous mission to ready "at my command" on the moving target mission). The battlefield situation, training, and combat status of the observer and firing unit, and other factors will affect reaction times. This may require the observer to identify two trigger points for planned missions: one to initiate the **AT MY COMMAND** or **BY ROUND AT MY COMMAND** mission and one to send the **FIRE** command.



## TRIGGER AND INTERCEPT POINT CONSIDERATIONS

5-137. Ideally the trigger and intercept points will be an easily identifiable point, terrain feature, or object. This is often difficult to accomplish for targets of opportunity, but for planned targets, the observer frequently has more flexibility in selecting points that will facilitate the execution of the fires.

5-138. However, the observer will often be unable to plan the intercept and trigger point for a planned moving target on easily identifiable objects or terrain features. In these cases, the observer should identify the appropriate point on the ground, then determine and record the direction, distance, and vertical azimuth to the point. This should be done from the point at which the target will be observed during the battle to ensure accuracy. Laser designators and rangefinder are extremely useful for this purpose. Trigger points established in this manner are often referred to as laser triggers, as opposed to physical trigger.

### TRIGGER POINT MARKING

5-139. If time and conditions permit, the observer may want to mark the trigger points so that they are more visible under various battlefield conditions. While this is especially useful for laser triggers (a laser trigger becomes a physical trigger when marked), it may also be beneficial when the object or terrain feature of a physical trigger may not be easily identifiable under conditions of limited visibility. Often, observers can mark a trigger point together with target area survey and refinement.

5-140. In some instances, the observer may also want to mark the intercept point, especially if direct fire weapons or air assets will jointly attack the target or if planned fires are the backup attack means. The marking of the intercept point allows these systems and other observers to orient on the location and record the data for future use.

5-141. As much as possible, trigger markers should be observable by multiple observers or from multiple locations (in case the observer must move). They should also blend in with the terrain or be placed so that they are not obvious to the adversary. Trigger markers should also be coordinated with the maneuver unit's direct fire target reference point. All types of trigger markers have limitations that the observer must understand.

5-142. A trigger marker may be visual or thermal. A visual trigger marker, such as a marking panel or chemical light, is clearly visible to normal eyesight (binoculars may be required) under ideal conditions but is affected by night, fog, and other adverse conditions. A thermal trigger (for example, burning charcoal, reverse polarity tape, or a VS-21 panel [the VS-17 panel is normally not visible in thermal sights]) is visible day or night, but may be impacted by dense smoke or fires (burning equipment, munitions, or vegetation) and will only be visible as long as they produce the thermal signature. Use markers that have limited visibility or short durations (and require replacement or replenishment) for marking triggers closer to the observer's location.

5-143. Reverse polarity tape is difficult to observe beyond 5 kilometers. It is visible through a thermal sight day and night, and adverse weather rarely affects the tape severely. A 5 gallon antifreeze can containing sand and diesel will rarely emit a thermal signature beyond 6 hours. Plywood panels are difficult to conceal from adversary observation. Chemical lights are usually too small to observe from long distances and may be visible to the adversary. Laser triggers minimize the limitations of physical triggers, as they are virtually undetectable to the adversary and require little time to emplace. However, they require a mounted or dismounted observer with a laser designator and rangefinder to maintain a stationary location. If the observer moves, then the established trigger is no longer valid. A combination of laser and physical triggers is the most effective method of establishing trigger points.

5-144. Plan the placement and lighting and initiation of trigger markers such as chemical lights or thermals based on their durations, effects, and other applicable considerations. Plan and assign responsibilities as timeline events. Emplacement can be centralized, with one person, such as the fire support noncommissioned officer (NCO) emplacing all trigger markers, or it may be decentralized, with each observer or platoon responsible for emplacing their assigned trigger markers. There are several methods for emplacing and initiating trigger markers:

- The observer, another member of the fire support team, or a member of the supported maneuver unit can go forward at an appropriate time and emplace or light and initiate the trigger marker(s). The individual should have communications and confirm that the marker is visible and properly emplaced. Do this in conjunction with target reference point markers to reduce movement and save time. This is the preferred method.
- A member of any forward security forces can emplace or initiate and light the trigger markers as they pull back from their forward locations. Usually this should be a fire support Soldier familiar with the trigger marker plan.

5-145. Fire support leaders should develop a trigger marker employment plan that best addresses the mission variables, supports the maneuver commander’s plans, and ensures that primary and alternate observers can observe the trigger points.

**RECORDING DATA**

5-146. For planned targets, the observer should record the distance, direction, and vertical azimuth from the observation point to all trigger and intercept points (use laser designator and rangefinder if available) as well as a brief description of the points. This allows the observer, or other members, to orient on the points quickly, which is especially helpful when visibility is limited. It also facilitates battle hand over if observers change. The observer can also record any of the other factors, such as firing unit and time of flight, that are essential to his time distance and execution calculations.

**HELPFUL NOTES**

5-147. Table 5-6 provides some additional notes for observers.

**Table 5-6. Helpful notes for the observer**

<i>Helpful Notes For The Observer</i>
Apply the observer-target factor to obtain corrections for height of burst as well as for deviation.
Often, initial rounds can be located more quickly with the naked eye than with field glasses. The spotting should be instantaneous and the correction sent immediately to the fire direction center.
For observers who wear glasses, remove the protective plastic lens cap on the binoculars to increase the field of vision. Use masking tape on the metal retaining ring to prevent scratching the glasses.
Tape the diopter adjustment ring in the correct position so that the observer does not have to adjust the diopter setting every time the binoculars are used.
For adjust fire missions, measure angular deviations with the binoculars to the nearest 5 mils for deviation and one mil for height of burst.
A good terrain sketch provides an observer direction and a means for making a good terrain map association.
An observer can use the direction and flash-to-bang time of an impacting round to determine its approximate grid location.
The observer must take immediate action if communications equipment is not working properly.
The importance of accurate initial fires (fire for effect) cannot be overemphasized. The adversary will change posture (dig in or move) if being fired upon.

## Chapter 6

# Special Munitions

This chapter discusses the characteristics and any special considerations or procedures required to fire special munitions.

### CHARACTERISTICS OF THE EXCALIBUR

6-1. The M982 series Excalibur is a 155-mm GPS aided and internal measurement unit guided projectile that uses a jam resistant GPS receiver and a guidance package that enables the projectile to fly with GPS accuracy to preprogrammed aim points independent of range. The projectile uses a gliding airframe to achieve extended range.

6-2. Excalibur delivers a high explosive warhead out to ranges between 8 and 37.5 kilometers with a circular error probable (CEP) of less than 10 meters. CEP is an indicator of the delivery accuracy of a weapon system, used as a factor in determining probable damage to a target. It is the radius of a circle within which half of a missile's projectiles are expected to fall (JP 3-60).

6-3. Excalibur has three fuze options: point detonating, delay and proximity with a HOB of 4 meters.

6-4. Excalibur is only fired in high angle fire. This allows maximum acquisition time for the GPS receivers and guidance components, and for corrections along the guided portion of the trajectory. High angle fire optimizes the ranges Excalibur can achieve, due in large part to the projectile's aerodynamic design and features that allow the projectile to glide, thus achieving greater range than a purely ballistic trajectory projectile. The Excalibur's guidance system corrects its flight path for optimum attack angle and precise engagement of the provided coordinates. Once near the target location, Excalibur performs a top down maneuver that allows for a nearly vertical attack angle on the target.

6-5. Excalibur does not require laser designation and cannot be guided onto the target by a laser. It is not designed to destroy buildings or as a tank killer. The Excalibur projectile has roughly the equivalent explosive power of a standard M107 artillery projectile. The unitary warhead has a hardened casing that enables it to penetrate four inches of reinforced concrete before detonating (fuze delay). Table 6-1 describes the primary benefits of Excalibur.

**Table 6-1. Characteristics of Excalibur**

<i><b>EFFECTIVENESS</b></i>	<i><b>SURVIVABILITY</b></i>	<i><b>SUSTAINABILITY</b></i>
Greater first round accuracy	Extended range allows positioning out of range of hostile indirect fire systems	Reduction in ammunition tonnages required to support the force
Enhanced effects on targets due to accuracy	Extended range allows optimal use of cover & concealment	Expands cannon artillery target set; freeing other fire support assets (higher echelon, fixed wing) for other missions
Precise engagement mitigates	Fewer rounds fired = less probability of detection	

## BALLISTIC IMPACT POINT

6-6. A *ballistic impact point (BIP)* is the location on the ground where a projectile will impact if it were to follow an unguided ballistic path. For example, in the event an Excalibur projectile does not acquire adequate GPS signal, or experiences a reliability failure in flight, the round is designed to continue on a non-guided ballistic trajectory to a BIP without arming and impact as a dud, normally burying itself from 4 to 12 feet in the ground (actual depth depends on the soil conditions). Issues exist concerning collateral damage and the possibility of the adversary using the dud to manufacture an improvised explosive device. It is important that the risk of an errant round be managed with the appropriate level of importance, given the adversary, tactics and politics of the situation.

### PREDICTED BIP

6-7. The artillery computer system determines a predicted BIP for every Excalibur mission fired. The predicted BIP is a calculated impact point that may drift away from the gun-target line due to the effects of meteorological conditions. It is also important to understand that ballistic dispersion error can cause the round to impact as much as 500 meters from the predicted BIP. If this location does not lie beyond the coordinated fire line and fire support coordination line then this location must be cleared with maneuver as if it were a target location. The supported maneuver commander, however, may be willing to accept risk in clearing these BIP locations given the fact that if an Excalibur round does fly a ballistic flight path to one of these locations it should impact as a dud, thus causing minimal collateral damage and posing little risk to friendly troops. The munition flight path trajectories are displayed on the same artillery computer system that computed the ballistics. This information may be passed up the organizational chain, particularly for airspace control.

### FORCED BIP

6-8. A user defined or forced BIP is described as a point and should be located at least 500m from all sensitive structures or areas. Forced BIPs facilitate the rapid employment of Excalibur with minimized risk of a failed round impacting near a sensitive area. It is a spot on the ground that is pre-cleared with the maneuver commander for use as a BIP for Excalibur missions. With the use of a pre-cleared forced BIP, only the target location needs clearing with the supported maneuver unit. If the round were to malfunction and follow a ballistic path, it would then impact in this pre-cleared location, which greatly narrows the search area if the round must be recovered due to improvised explosive device concerns. The commander may choose to define a large area as either a limited access area or a free fire area within which several forced BIPs may be selected anywhere within the limited access area or free fire area boundary. This technique provides greater flexibility in selecting the BIP and allows some latitude for the battery and platoon FDC to select forced BIPs within the limited access area or free fire area. Again, the maneuver commander may be willing to accept some risk in designating a BIP since any Excalibur round that would impact in the BIP would be a dud.

---

*Note.* A limited access area graphic is comprised of a general area graphic, which defines the area and relays the nature of the hazard or obstacle, and a pentagon, which denotes the unit or equipment type that is restricted from the area. See MIL-STD-2525D for more information on the limited access area.

---

## SAMPLE EXCALIBUR MISSION

Tables 6-2 and 6-3 (on page 6-3) provide sample Excalibur calls for fire. The grid location will always be expressed to a minimum of 10 digits. The observer specifies the Target Location Error to the FDC based on the capabilities of the observer and equipment used in the target location portion of the CFF.

**Table 6-2 Fire for effect Excalibur with proximity fuze**

<i>Observer</i>	<i>Fire Direction Center</i>
P51 THIS IS P87, FIRE FOR EFFECT, OVER.	
	P87 THIS IS P51, FIRE FOR EFFECT, OUT.
GRID NK3725146171 ALTITUDE 345 TLE 7 METERS, OVER	
	GRID NK3725146171 ALTITUDE 345 TLE 7 METERS, OUT.
RPG GUNNER ON ROOFTOP, EXCALIBUR, PROXIMITY, OVER.	
	RPG GUNNER ON ROOFTOP, EXCALIBUR, PROXIMITY, OUT.
<b>Legend.</b> TLE—target location error    RPG—rocket propelled grenade	

**Table 6-3. Fire for effect Excalibur with delay fuze**

<i>Observer</i>	<i>Fire Direction Center</i>
P51 THIS IS P87, FIRE FOR EFFECT, OVER.	
	P87 THIS IS P51, FIRE FOR EFFECT, OUT.
GRID NK9336187631, ALTITUDE 105 TLE 5 METERS, OVER.	
	GRID NK9336187631, ALTITUDE 105 TLE 5 METERS, OUT.
SNIPER ON TOP FLOOR OF BUILDING, EXCALIBUR, DELAY, OVER.	
	SNIPER ON TOP FLOOR OF BUILDING, EXCALIBUR, DELAY, OUT.
<b>Legend.</b> TLE—target location error	

6-9. For more information on Excalibur, see TB 9-1320-203-10.

## **CHARACTERISTICS OF THE ACCELERATED PRECISION MORTAR INITIATIVE (APMI)**

6-10. The Accelerated Precision Mortar Initiative (APMI) is an organic, indirect fire capability that provides all weather, precision-guided munition to infantry battalions. APMI is a capability intended to maximize the infantry battalion's ability to defeat targets in situations where rules of engagement would otherwise not allow target engagement due to collateral damage concerns or to exposing Soldiers to adversary weapon systems. It is available to the commander to employ in complex, mountainous, restrictive terrain, and urban environments. Its accuracy mitigates collateral damage and reduces the number of rounds required to create the desired effect on the target.

6-11. APMI is a system of systems composed of four systems which include the XM395 mortar cartridge, the XM701 Precision Lightweight Universal Mortar Setter System (PLUMSS), the M32 Lightweight Handheld Mortar Ballistic Computer and the M150/M151 Mortar Fire Control System Dismounted.

6-12. APMI XM395 cartridge uses a standard M934 high explosive 120mm mortar projectile body. In the nose, a GPS receiver and computer controlled aerodynamic directional fins keep the round on its programmed trajectory. Folding fins in the tail provide stability.

6-13. APMI also has a multi-functional fuze, which allows the round to be programmed to "explode in the air" the fuze mode is proximity as opposed to a time setting. APMI will only denote at a factory determined height of burst which user/soldier may not change to detonate along the trajectory.

6-14. In order for the autonomous flight and fuze control to function properly, operators must input mission and GPS data from a fire control computer into the round using a setting device.

6-15. The characteristics of the APMI and the call for fire are similar to the Excalibur CFF. Table 6-4 on page 6-4 provides an example APMI call for fire.

**Table 6-4. Fire for effect with APMI**

<i>Observer</i>	<i>Fire Direction Center</i>
P51 THIS IS P87, FIRE FOR EFFECT, OVER.	
	P87 THIS IS P51, FIRE FOR EFFECT, OUT.
GRID NK36654237 ALTITUDE 345, OVER.	
	GRID NK36654237 ALTITUDE 345, OUT.
IED EMPLACERS IN THE OPEN, APMI, OVER.	
	IED EMPLACERS IN THE OPEN, APMI, OUT.
<b>Legend.</b> APMI – Accelerated Precision Mortar Initiative	

## CHARACTERISTICS OF THE PRECISION GUIDANCE KIT

6-16. The M1156 Precision Guidance Kit (PGK) is an inductively set GPS-guided fuze. PGK is set using the M1155 Enhanced Portable Inductive Artillery Fuze Setter (EPIAFS) to transfer power and initialization data (GPS data, satellite data, gun and target locations, fuze mode, and trajectory algorithms). The PGK-fuzed round is fired along a computed reference trajectory. As the round travels along its ascending branch it acquires GPS and begins guidance at apogee. As the round drifts onto a ballistic trajectory, canards on the fuze correct the projectile's flight in range and deflection back to the reference trajectory to guide the round to the programmed target grid. It is essential that the unit meet the five requirements for accurate fire in order to compute the correct reference trajectory and put PGK within its maneuver authority relative to the target. PGK has a  $\leq 50$ m CEP and is authorized fire use on the M795 HE and M549A1 HERA projectiles fired from the M777A2 and M109A6 Paladin. The M1156 PGK has two fuze modes, point detonating (PD), and proximity (PROX).

6-17. PGK provides a precision capability that gives the maneuver commander an increased capability to create effects with HE projectiles from 13km out to the maximum range of the projectile. PGK can be employed at ranges of 8km and beyond, however, at these shorter ranges, due to inherent CEP of conventional munitions, PGK may not provide any increase in accuracy. This is contributed to the  $\leq 50$  meter CEP at all ranges with a PGK fuzed projectile allowing for the greater efficiency of the rounds fired. This increased efficiency means fewer rounds to create the desired effects on the target. It will allow commanders to shape tactical engagements, mass effects to support maneuver and lessen over reliance on direct fires. At unit and Soldier level, PGK will be used in much the same manner as current cannon fuzes and its employment will be almost seamless since it uses the same procedures in place today.

6-18. The changes to the standard CFF request format include requesting PGK as the fuze type and reporting TLE in the target location portion of the CFF. If the observer does not include the TLE in the CFF request, the FDC will then prompt the observer to provide TLE, if available.

## CHARACTERISTICS OF THE GUIDED MLRS

6-19. The M30 Guided Multiple Launch Rocket System (GMLRS) integrates a GPS aided inertial guidance and control package into a dual purpose improved conventional munitions (DPICM) Multiple Launch Rocket System (MLRS). Unlike the traditional free flight M26 series rockets, whose accuracy degrades as the range to the target increases, the GMLRS provides consistent improved accuracy from a 15 kilometer minimum range to a maximum range of 70+ kilometers. Improvements in accuracy increase lethality, while reducing rocket expenditures and reducing the risk of collateral damage that is normally associated with free flight munitions. Each M30 GMLRS rocket contains 404 M101 sub munitions effective against personnel and soft to lightly armored targets.

6-20. The M31/M31A1 GMLRS warhead is a 200 pound class scored steel case fragmentation high explosive warhead. Maximum range exceeds 70 kilometers. In addition to providing point detonating, delay, and proximity fuzing options, a vertical attack trajectory option exists to enable employment in urban environments and in maximizing effectiveness of delay and proximity fuze modes. The proximity fuze mode causes warhead detonation at approximately 7 meters above the target, the point detonating mode causes detonation upon impact, and the delay mode causes detonation as the nose cone penetrates about one meter into the ground, this places the explosive filled canister partially below the surface of the ground.

## SAMPLE GLMRS MISSION

6-21. Request GMLRS in a standard call for fire just like any other specific ammunition. Table 6-5 provides a sample GMLRS call for fire. Planned GMLRS missions currently require a mensurated target location.

**Table 6-5. Fire for effect with GLMRS unitary**

<i>Observer</i>	<i>Fire Direction Center</i>
P51 THIS IS P87, FIRE FOR EFFECT, OVER.	
	P87 THIS IS P51, FIRE FOR EFFECT, OUT.
GRID NK3667823710, ALTITUDE 125, OVER.	
	GRID NK3667823710, ALTITUDE 125, OUT.
FIVE ADVERSARY PERSONNEL NEAR BUILDING, GMLRS UNITARY, PROXIMITY, OVER.	
	FIVE ADVERSARY PERSONNEL NEAR BUILDING, GMLRS UNITARY, PROXIMITY, OUT.
<b>Legend.</b> GMLRS—guided multiple launch rocket system	

## CHARACTERISTICS OF IMPROVED CONVENTIONAL MUNITIONS

6-22. Improved conventional munitions are base ejection projectiles with a mechanical time fuze and a body assembly containing a number of sub munitions (grenades). Centrifugal force dispenses the grenades radially from the projectile line of flight. The size and shape of the sub munitions dispersion patterns are not constant and change over range. In addition, the concentration of sub munitions is not uniform over the entire surface area. There is a noticeable decrease of sub munitions in the center of the dispersion pattern. There are two types of ICM rounds: the antipersonnel round and the dual purpose round. Table 6-6 shows the number of grenades in each ICM round.

**Table 6-6. Improved conventional munitions**

<i>Weapon</i>	<i>Munition</i>	<i>Number of Sub Munitions (Payloads)</i>
<b><i>Antipersonnel ICM</i></b>		
155-mm (Figure 6-1)	M449 family	60
<b><i>Dual-purpose ICM</i></b>		
155-mm (Figure 6-2)	M483A1	88
155-mm	M864	72
105-mm	M915	42
MLRS	M26 Rocket	644 M77
MLRS	ER MLRS	518 XM85
MLRS	GMLRS	400+ XM85
<b>Legend.</b> ER—extended range mm—millimeter		
GMLRS—guided multiple launch rocket system MLRS—multiple launch rocket system		

## ANTIPERSONNEL ROUND

6-23. The antipersonnel improved conventional munitions (APICM) (see figure 6-1) are most effective against unwarned, exposed personnel. When the fuze functions, an expelling charge forces the grenades out through the base of the projectile. Small vanes on each grenade flip upward, arming the grenade and stabilizing it in flight. When the striker plate on the base of the grenade contacts the ground, the grenade is hurled upward four to six feet and detonates. M449 APICM dispersion pattern is generally elliptical in shape. The dispersion pattern covers approximately 100 meters by 60 meters. APICM is no longer manufactured but is still held in war reserve.

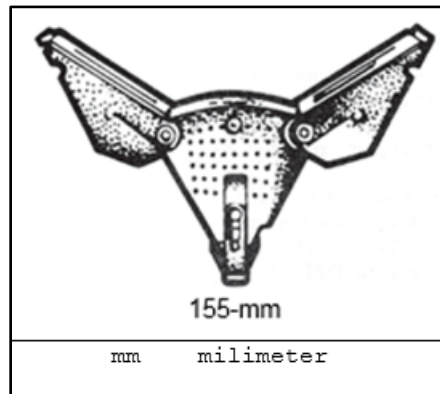

Figure 6-1. APICM grenades

## DUAL PURPOSE ROUND

6-24. DPICM grenades (see figure 6-2) are most effective against lightly armored or thin skinned vehicles. After the grenade is ejected, a ribbon streamer arms and stabilizes it. On impact, a shaped charge that can pierce light armor is detonated. The surrounding steel case fragments are very effective against personnel as well.

6-25. M438A1 DPICM dispersion generally changes shape from elliptical at minimum ranges and lower charges to almost circular at maximum ranges. At minimum ranges, the dimensions are approximately 50 meters by 100 meters. At maximum ranges, they are approximately 100 meters by 120 meters.



Figure 6-2. 155-mm DPICM grenade



## BASE BURN ROUND

6-26. The M864 base burn DPICM has a larger dispersion pattern than that of the M438A1 DPICM despite having fewer grenades. However, because it is designed for employment at longer ranges, which produces a steep angle of fall, the dispersion pattern is typically circular. At its designed ranges, the dispersion pattern covers approximately 150 meters by 150 meters.

## ICM CALL FOR FIRE AND ADJUSTMENT

6-27. The ICM call for fire is the same as any call for fire. The observer identifies the type of ICM requesting to be fired in effect by referring to APICM as APICM and DPICM as ICM. Base burn DPICM is normally employed at ranges beyond the M438A1 DPICM, as determined by the FDC. Normal corrections for HE in adjustment apply; however, the fire for effect phase is entered once a 100 meter bracket is split.

## RANGE AND DEVIATION

6-28. Because of the size of the effects pattern, do not make deviation shifts of less than 50 meters and range corrections of less than 100 meters.

## HEIGHT OF BURST

6-29. Because of the reliability of the round, no adjustment for HOB is required before firing for effect. If a repeat of fire for effect is required, adjust the HOB. Adjust the HOB in increments of 50 meters.

6-30. If a large number of duds are observed or the effects pattern is too small, the observer should give an UP correction. This correction should not exceed 100 meters.

## DANGER CLOSE

6-31. When adjusting close in fires with ICM, the observer must start the adjustment at least 600 meters from friendly troops, depending on the relative locations of weapons, target, and friendly troops. Give special consideration to the direction and speed of the wind in the target area. Make adjustments with the entire battery. Make corrections from the edge of the effects pattern nearest to the target.

## SAMPLE ICM MISSIONS

6-32. Tables 6-7 through 6-9 (on page 6-8) provide sample ICM calls for fire.

**Table 6-7. Fire for effect with ICM**

<i>Observer</i>	<i>Fire Direction Center</i>
P51 THIS IS P87, FIRE FOR EFFECT, OVER.	
	P87 THIS IS P51, FIRE FOR EFFECT, OUT.
GRID NK372461 ALTITUDE 205, OVER.	
	GRID NK372461 ALTITUDE 205, OUT.
BMP PLATOON ASSEMBLY AREA, ICM, OVER.	
	PLATOON ASSEMBLY AREA, ICM, OUT.
<b>Legend.</b> BMP—Russian designed armored personnel carrier ICM—improved conventional munitions	

**Table 6-8. HE adjustment, APICM in effect**

<i>Observer</i>	<i>Fire Direction Center</i>
P51 THIS IS P87, ADJUST FIRE, OVER.	
	P87 THIS IS P51, ADJUST FIRE, OUT.
GRID NK933876 ALTITUDE 155, OVER.	
	GRID NK933876 ALTITUDE 155, OUT.
INFANTRY COMPANY HALTED, APICM IN EFFECT, OVER.	
	INFANTRY COMPANY HALTED, APICM IN EFFECT, OUT.
<b>Legend.</b> APICM—antipersonnel improved conventional munitions	

**Table 6-9. ICM adjustment, ICM in effect**

<i>Observer</i>	<i>Fire Direction Center</i>
P51 THIS IS P87, ADJUST FIRE, OVER.	
	P87 THIS IS P51, ADJUST FIRE, OUT.
GRID NK361290 ALTITUDE 265, OVER.	
	GRID NK361290 ALTITUDE 265, OUT.
COMPANY ASSEMBLY AREA, ICM, OVER.	
	COMPANY ASSEMBLY AREA, ICM, OUT.
<b>Legend.</b> ICM—improved conventional munitions	

## ICM CONSIDERATIONS

6-33. Anytime ICM rounds are fired, between 2 and 3 percent of the sub munitions fail to arm or detonate. This rate can be higher if correct employment procedures are not followed or if ICM are delivered into a target area where the terrain is not suited for ICM employment.

6-34. Dud sub munitions can pose significant risks to friendly personnel and equipment. The fire support officer (FSO) must advise the commander and staff on the risks associated with ICM employment. Compare this risk assessment to the effectiveness of using ICM in meeting the commander's guidance for fire support.

6-35. Planning for ICM attack of targets should incorporate the following employment and safety considerations.

## EMPLOYMENT CONSIDERATIONS

6-36. Use caution when considering ICM employment in forests, mountainous areas (slope greater than 60 percent), rocky uneven terrain, soft marshy areas, or into target areas covered with deep snow or water. Advise supported commanders that they can anticipate higher dud rates for ICM sub munitions in these conditions.

## SAFETY CONSIDERATION`

6-37. Ensure personnel are trained to identify various sub munitions and are aware of their hazards.

6-38. Establish and follow procedures for disseminating information concerning areas where dud ICM sub munitions pose a hazard to friendly operations.

## CHARACTERISTICS OF FIELD ARTILLERY SCATTERABLE MINES

6-39. In the field artillery, a scatterable mine refers to the two types of field artillery delivered scatterable mines, the remote antiarmor mine system and area denial artillery munitions. See ATP 3-34.22 and TM 43-0001-28 for additional information on the RAAMS and ADAM.

6-40. The planning associated with obstacles is the responsibility of the engineer cell. The relationship between the engineer and fires cells is crucial, as these minefields are delivered by field artillery assets.

### RAAMS PROJECTILES

6-41. Use RAAMS projectiles to delay or disrupt adversary formations and maneuver or to reinforce existing obstacles. A 155-mm howitzer fires the RAAMS projectile which base ejects antiarmor mines (see figure 6-3) over the target area. After a short delay to allow for mine freefall, impact, and roll, the magnetically fuzed mines arm themselves. Upon arming field artillery delivered scatterable mines perform a self-test. All mines that fail the self-test SD immediately. Any metallic object such as a tank or self-propelled vehicle passing over the armed mines will cause the mines to detonate. 20 percent of RAAMS mines have antidisturbance features that cause the mines to detonate if they are moved or picked up. If not detonated, RAAMS mines begin to self-destruct after 80 percent of the factory set SD time elapses. The probability of a live mine existing past its stated SD time is 0.001. The SD time for the munitions are:

- The M718 and M718A1 projectiles have a long SD time (48 hours).
- The M741 and M741A1 projectiles have a short SD time (4 hours).

---

*Note.* Most RAAMS (and ADAM) mines arm in two minutes. Production improved mines (type designated A1 arm in 45 seconds)

---

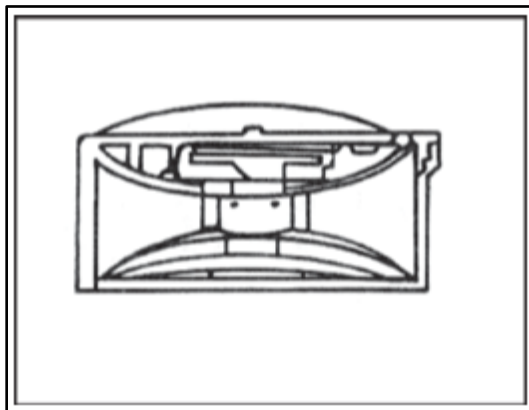

Figure 6-3. RAAMS mine

### ADAM PROJECTILES

6-42. Use ADAM mines against personnel, dismounted personnel in an armored attack, or on existing antitank obstacles to hinder dismounted breaching. When employed against an adversary that has a dismounted breaching capability, deliver ADAM mines directly on top of a RAAMS minefield. ADAM rounds are always the last rounds fired when used in conjunction with RAAMS or other munitions. This prevents the accidental destruction of the ADAM munitions by other munitions.

6-43. A 155-mm howitzer fires the ADAM projectile which base ejects 36 antipersonnel mines (see figure 6-4 see on page 6-10) over the target area. When an ADAM mine comes to rest on the ground, several tripwire sensors are deployed out to a maximum distance of 20 feet. When a sensor is disturbed or tripped, it propels a small ball like munition two to eight feet upward. The munition detonates and scatters approximately 600 1.5 grain steel fragments in all directions. If not detonated, the ADAM mines will begin to SD after 80 percent of the factory set SD time elapses. The destruct times for the munitions are:

- The M692 projectile has a long SD time (48 hours).
- The M731 projectile has a short SD time (4 hours).

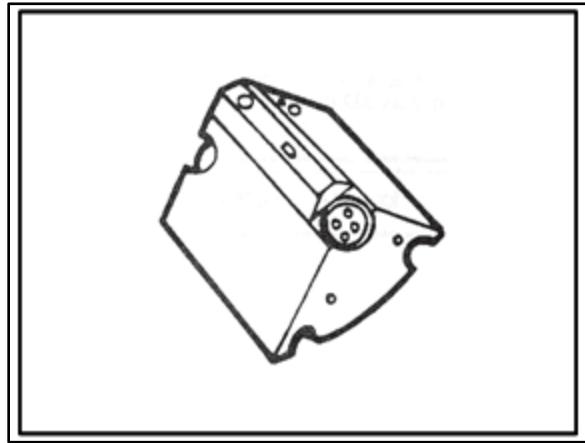

**Figure 6-4. ADAM mine**

## **TYPES OF MINEFIELDS**

6-44. FSOs use three types of RAAMS and ADAM minefields to support the commander's scheme of maneuver and to provide maximum troop safety. The three types are planned, target of opportunity, and minefields used with other munitions.

### **PLANNED MINEFIELDS**

6-45. Planned minefields are scheduled or on-call targets that support barrier or obstacle plans and are included on a target list. They require extensive coordination between maneuver, engineer, and fire support. Planned minefields may consist of long or short SD mines. Minefield safety zones are computed before firing.

### **TARGET OF OPPORTUNITY MINEFIELDS**

6-46. Initiate target of opportunity minefields when requested in a call for fire. They consist of only short SD mines and provide the supported commander with an immediate minefield. The standard minefield module is 400 meters by 400 meters. The minefield may consist of a combination of 24 RAAMS and 6 ADAM projectiles (these numbers may change depending on the adversary, commander's guidance, and the unit's SOP). The safety zone is based on a single aimpoint and is computed immediately after the minefield is fired.

### **MINEFIELDS USED WITH OTHER MUNITIONS**

6-47. Minefields established in conjunction with an attack using other munitions such as HE or DPICM may be either a planned minefield or target of opportunity minefield. They consist of only short duration mines and are used to extend the delay, disruption, or destruction caused to the target. Size these minefields according to the method of attack and use RAAMS, ADAM, or a combination fired in the last volley. Firing the mines prior to the last volley risks detonating the mines as other munitions impact. Compute the safety zone immediately after firing.

## **SELECTION OF MINEFIELD DENSITY**

6-48. Selection of minefield density is based on the purpose of the minefield. Table 6-10 shows density selections available for RAAMS and ADAM.

Table 6-10. Minefield density for RAAMS and ADAM

<i>Purpose of Minefield</i>	<i>Density Designator for Minefield Planning Sheet</i>	<i>Density of Mines Per Square Meter</i>
<b>Remote Antiarmor Mine System (RAAMS)</b>		
Harassment	Low	0.001
Minefield covered by heavy direct fire	Medium	0.002
Minefield covered by light direct fire	High	0.004
<b>Area Denial Artillery Munitions (ADAM)</b>		
Used with RAAMS or other antitank obstacles or for harassment	Low	0.0005
Minefield covered by heavy direct fire	Medium	0.001
Minefield covered by light direct fire	High	0.002
<b>Note.</b> A density of 0.001 gives an average on one mine in every 1,000 square meters of minefield or one mine in every 32 X 32 meter square.		

## SELECTION OF SD TIME

6-49. The selection of the SD time is based on several considerations:

- Scheme of maneuver (current as well as future operations).
- Type of minefield (planned or standard target of opportunity).
- Minefield location.
- Tactical situation (offense or defense).
- Nature of adversary forces.
- Availability of projectiles.
- Time frame involved.
- Command authority to emplace scatterable mines.

## TARGET LOCATION

6-50. Location and placement of the minefield is determined by the commander to support the scheme of maneuver.

## MOVING TARGET AIMPOINT

6-51. Place the aimpoint for a moving target directly in front of the adversary axis of advance 1,000 meters in front of the adversary target for every 10 kilometers per hour of speed as shown in figure 6-5 on page 6-12. This allows enough time for mine delivery and arming before an adversary passed through the minefield.

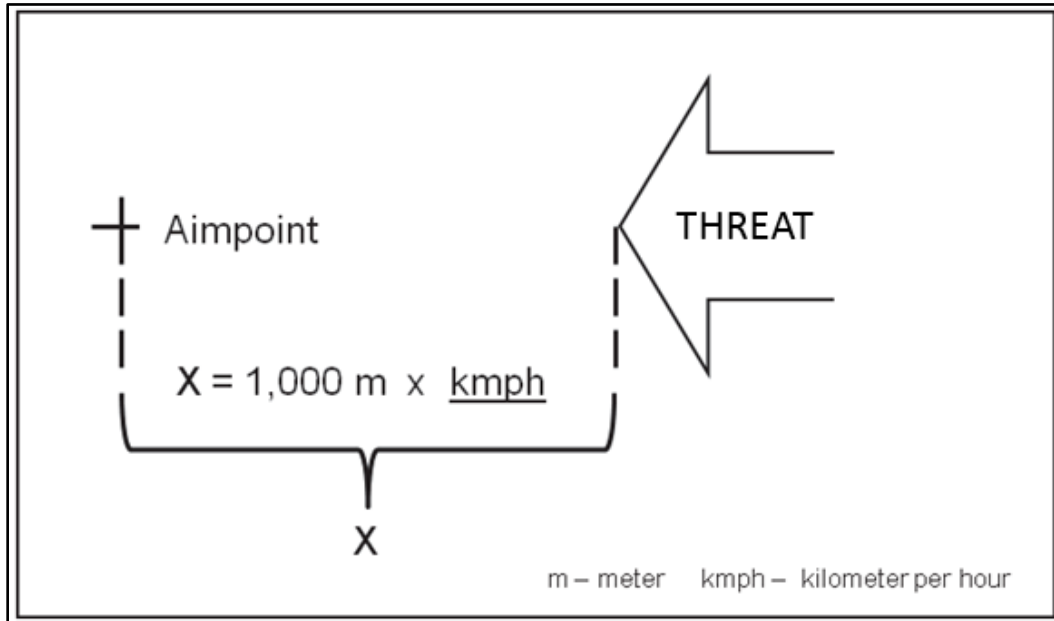

**Figure 6-5. Aimpoint location for moving targets**

**STATIONARY TARGET AIMPOINT**

6-52. Place the aimpoint for a stationary target over the target center as shown in figure 6-6. Figure 6-6 Aimpoint location for stationary targets shows a company area template but no aimpoint.

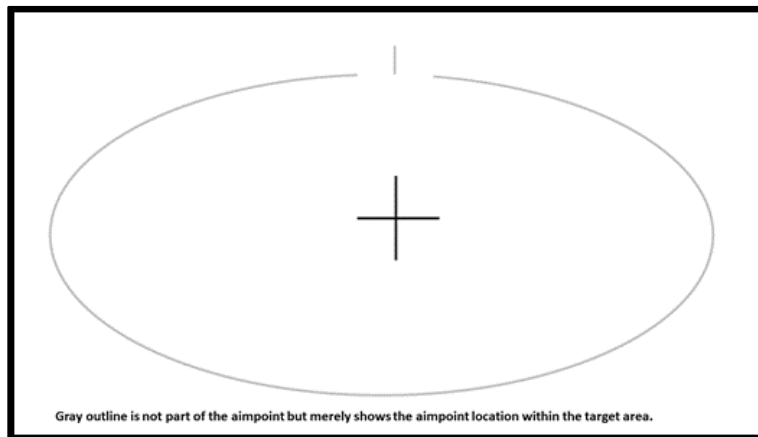

**Figure 6-6. Aimpoint location for stationary targets**

**CALL FOR FIRE AND ADJUSTMENT**

6-53. Generally, the call for fire for scatterable mines is transmitted and processed in the same manner as other target of opportunity fire missions. Unless the observer requests ammunitions for adjustment, the observer will receive self-registering DPICM in adjustment and the standard minefield in effect (24 RAAMS and 6 ADAM).

6-54. Targets of opportunity are either fire for effect or adjust fire missions. Do not request a fire for effect mission if the center of the minefield is less than 700 meters from the nearest friendly position. Do not request an adjust fire mission if the center of the minefield is less than 425 meters from the nearest friendly position.

6-55. Adjustment procedures for field artillery delivered scatterable mines are identical to those described for ICM.

### WARNING

**Scatterable mines should never be emplaced closer than 425 meters from friendly positions.**

## SAMPLE SCATMINE MISSIONS

6-56. Tables 6-11 and 6-12 provide sample scatterable mine calls for fire.

**Table 6-11. Fire for effect mission with ADAM**

<i>Observer</i>	<i>Fire Direction Center</i>
P51 THIS IS P87, FIRE FOR EFFECT, OVER.	
	P87 THIS IS P51, FIRE FOR EFFECT, OUT.
GRID NK18045132 ALTITUDE 235, OVER.	
	GRID NK18045132 ALTITUDE 235, OUT.
PLATOON IN THE OPEN, ADAM, OVER.	
	PLATOON IN THE OPEN, ADAM, OUT.
<b>Legend.</b> ADAM—area denial artillery munitions	

**Table 6-12. AF mission with RAAMS**

<i>Observer</i>	<i>Fire Direction Center</i>
STEEL 57 THIS IS BANDIT 42, ADJUST FIRE, OVER.	
	STEEL 57 THIS IS BANDIT 42, ADJUST FIRE, OUT.
GRID NK180513 ALTITUDE 105, OVER.	
	GRID NK180513 ALTITUDE 105, OUT.
FIVE T-80 TANKS ATTACKING, RAAMS IN EFFECT, OVER.	
	FIVE T-80 TANKS ATTACKING, RAAMS IN EFFECT, OUT.
<b>Legend.</b> RAAMS—Remote Antiarmor Mine System	

## CHARACTERISTICS OF ILLUMINATION

6-57. Illumination provides friendly forces with enough light to aid them in ground operations at night. It facilitates operations for the observer and the maneuver unit. The use of illuminating projectiles must be coordinated with other operations to avoid compromise of or interference with other friendly units, especially when night vision devices are being used.

6-58. The illumination shell is a base ejection projectile containing a flare attached to a parachute. It is used to—

- Illuminate areas of suspected adversary activity.
- Provide illumination for night adjustment of fires.
- Harass adversary positions.
- Furnish direction to friendly troops for attacks or patrol activities.
- Mark targets (by air and ground bursts) for attack by CAS.

- "Wash out" threat passive night sight systems when used at ground level.

## EMPLOYMENT CONSIDERATIONS

6-59. Illumination rounds may aid target acquisition when friendly forces are using image intensification devices (such as night vision devices), but can create problems when thermal sights are used. As the illumination flares burn out and land on the ground, they remain as a distinct hot spot seen through thermal sights for several minutes. This may cause confusion and make acquiring targets more difficult, especially when the flares are between the threat and the friendly forces.

6-60. The amount of illumination required for a particular mission depends on the observer-target distance; the conditions of visibility; and the size, width, and depth of the area to be illuminated. By selecting the proper illuminating pattern and controlling the rate of fire, the observer can light an area effectively with a minimum expenditure of ammunition. See table 6-13 for the rates of fire for continuous illumination and other information on the employment of illuminating shells.

**Table 6-13. Employment factors for illuminating shells**

<i>Howitzer or Mortar</i>	<i>Projectile</i>	<i>Initial Height of Burst (meters)</i>	<i>Distance Between Bursts (Spread) (meters)</i>	<i>Burning Time (seconds)</i>	<i>Rate of Continuous Illumination (rounds per minute)</i>	<i>Rate of Descent (meters per second)</i>
155-mm	M485A2	600	1000	120	1	5
155-mm	M1066 (IR)	700	1500	120	1	10
120-mm	M 930	500	890	50 to 60	2	8-10
120-mm	M930E1	500	890	50 to 60	2	8-10
120-mm	M91		890	46 to 60	2	8-10
120-mm	M 983 (IR)	500	1219	50 to 60	2	8-10
105-mm	M314A2	750	800	60	2	10
105-mm	M314A3	750	800	60	2	10
105-mm	M1064 (IR)	750	800	60	2	10
81-mm	M301A3	600	450	60	2	6
81-mm	M853A1	475	624	50	2	8-10
81-mm	M816 (IR)	475	855	50	2	8-10
60-mm	M721	425	460	40	2	8
60-mm	M767 (IR)	425	630	55	2	8
60-mm	M83A3 <sup>1</sup>	160	250	30	4	6

*Note.* <sup>1</sup>The 60-mm illuminating round M83A3 firing one round will provide moderate light over a square kilometer. The small size and limited burn time of the 60-mm illuminating round makes it more suitable for point illumination than for area illumination. The 60-mm illuminating round normally can be used without degrading night vision devices of adjacent units.

**Legend.** IR—infrared mm—millimeters

## ONE GUN ILLUMINATION

6-61. Use the one gun illumination pattern when effective illumination can be accomplished by firing one round at a time. To obtain this pattern, the observer calls for **ILLUMINATION** as the type of adjustment and type of projectile.



## TWO GUN ILLUMINATION

6-62. Use the two gun illumination pattern when an area requires more illumination than can be furnished by one gun illumination. In this pattern, two rounds burst simultaneously in the target area. To obtain this pattern, the observer calls for **ILLUMINATION TWO GUNS**.

### Two Gun Illumination Range Spread

6-63. Use this pattern (see figure 6-7) d illumination causes fewer shadows than illumination that is concentrated in one place. To obtain a range spread pattern, the observer calls for **ILLUMINATION RANGE SPREAD**. The FDC centers the spread over target location sent by the observer. See Table 6-13 for distances between bursts.

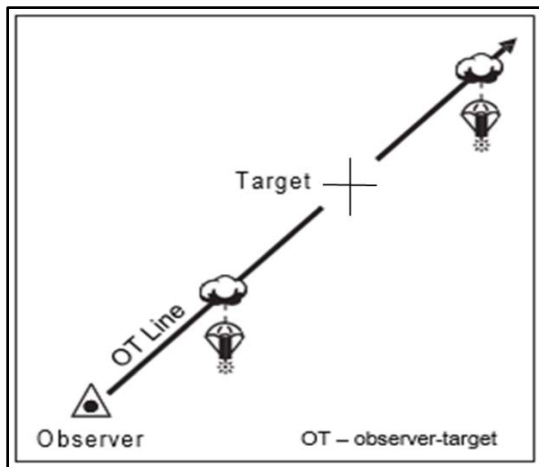

Figure 6-7. Illumination range spread

### Two Gun Illumination Lateral Spread

6-64. Use this pattern (see figure 6-8 on page 6-16) when the area to be illuminated has greater width than depth. To obtain a lateral spread pattern, the observer calls for **ILLUMINATION LATERAL SPREAD**. The FDC centers the spread over target location sent by the observer and orients the spread perpendicular to the observer-target line. Distances between bursts are the same as those for a range spread pattern (see table 6-13 on page 6-14).

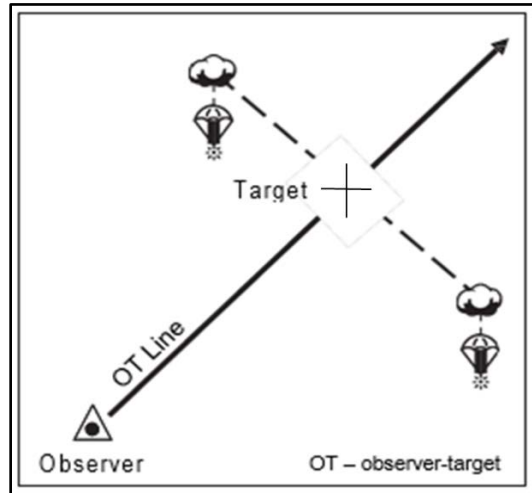

Figure 6-8. Illumination lateral spread

#### FOUR GUN ILLUMINATION PATTERN

6-65. Use this pattern to illuminate a large area (see figure 6-9). Four rounds are caused to burst simultaneously in a diamond pattern. This pattern illuminates an area with practically no shadows or dark spots. To obtain this pattern, the observer calls **for ILLUMINATION RANGE AND LATERAL SPREAD**. The pattern of the bursts combines both a range spread and a lateral spread.

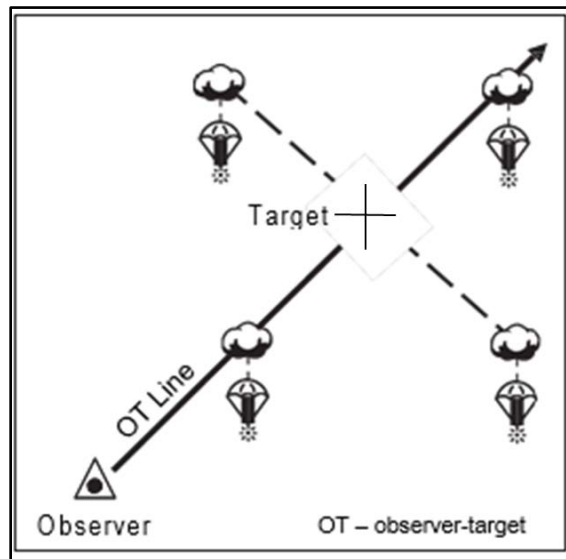

Figure 6-9. Illumination range and lateral spread

#### CALL FOR AND ADJUSTMENT OF ILLUMINATION

6-66. In the call for fire, specify **ILLUMINATION** as the type of projectile and give the appropriate range or lateral spread as the distribution.

## RANGE AND DEVIATION

6-67. Adjust range and deviation for illumination missions by using standard observed fire procedures. The adjustment of the illumination to within 200 meters of the target location is considered adequate because of the size of the area illuminated by the flare. Range and deviation correction of less than 200 meters should not be made.

## POSITION OF FLARE

6-68. The best position of a flare in relation to the area to be illuminated depends on terrain and wind. Generally, place the flare to one flank of the target area and at about the same range. In a strong wind, the point of burst must be some distance upwind from the area to be illuminated, because the flare will drift. If the target area is on a forward slope, the flare should be on a flank, at a slightly shorter range. For illuminating a very prominent object, visibility is better if the flare is placed beyond the object so the object is silhouetted.

## HEIGHT OF BURST

6-69. The proper height of burst (HOB) allows the flare to strike the ground just as it stops burning. Make any HOB corrections in multiples of 50 meters. Variations in time of burning between individual flares make any finer adjustment of the HOB impractical.

---

*Note.* When using a night observation device, the observer should ensure that the flare burns out appreciably (100 mils) above the adjusting point so as not to cause the device to wash out.

---

6-70. When burnout occurs during descent, estimate the HOB correction from the height of the flare when it burned out. When visibility permits, measure the spotting (height of the burnout above the ground) with binoculars. Multiply the HOB spotting (in mils) by the observer-target factor to determine the height of burnout (in meters). Express the HOB correction to the nearest 50 meters and send as a **DOWN** correction.

### Example

The flare burns out 20 mils above the ground. The observer-target factor is 3 mils;  $20 \times 3 = 60$  meters  $\approx$  50 meters. The correction is **DOWN 50**.

6-71. When the flare continues to burn after it strikes the ground, a correction is required to raise the HOB. The length of time, in seconds, that the flare burns on the ground is counted and multiplied by the rate of descent (see Table 6-14). Express the product to the nearest 50 meters and send as an **UP** correction.

### Example

The flare burned 23 seconds on the ground;  $23 \times 5$  (rate of descent for M845A2) = 115 meters. The correction is **UP 100** (expressed to the nearest 50 meters).

## COORDINATED AND CONTINUOUS ILLUMINATION

6-72. When the observer has located a target suitable for HE or other fire, initiates a call for fire in the normal manner. If no better means of designating the location of the target is possible, use the burst center of the illumination as a reference point.

6-73. If the observer decides to adjust the illuminating fire and the HE fire concurrently, the observer prefaces corrections pertaining to illumination with the word **ILLUMINATION** and those pertaining to HE with the letters **HE**; for example, **ILLUMINATION, ADD 200; HE, RIGHT 60, ADD 200**.

6-74. Once the observer has adjusted the illuminating shell to the desired location, the observer should control the rate of fire and number of pieces firing. This reduces ammunition expended to the minimum necessary for the required observation.

### COORDINATED ILLUMINATION

6-75. The observer allows the FDC to control the firing of illumination and HE by announcing **COORDINATED ILLUMINATION** in the call for fire. When the illumination has been adjusted to yield the best light on the target, the observer announces **ILLUMINATION MARK** to tell the FDC the exact time the target is best illuminated. The FDC times the interval between the actual firing of the illuminating round and the receipt of the observer's **ILLUMINATION MARK**. The observer would then announce **COORDINATED ILLUMINATION** and begin the secondary Call for Fire with the FDC handling the timing coordination. By comparing this time interval with the time of flight of the HE, the FDC can control the firing of the HE rounds, so that they arrive at the target during maximum illumination.

---

*Note.* Remember, the goal is adequate illumination to engage the target, not perfect illumination. Striving for perfect illumination may enable the target to escape.

*Note.* The Advanced Field Artillery Tactical Data System currently does not have the ability to conduct **COORDINATED ILLUMINATION** with a single target number. The FO (when using digital call for fire) need to initiate two separate fire missions: one for the Illumination, and one for the HE.

---

### CONTINUOUS ILLUMINATION

6-76. Because of the amount of ammunition expended, the least desirable method is for the observer to request **CONTINUOUS ILLUMINATION**. In this technique, the FDC fires illumination continuously (intervals between firing depend on the type of projectile) while the observer adjusts HE.

### Example

The observer hears a number of armor vehicles at an azimuth estimated at 5800, but cannot detect any lights and the entire area is in complete darkness. Judging from the sounds and a study of the map, the observer estimates the source of the noises to be approximately, grid NB616376. This location is about 2,000 meters from the observation post. The observer sends the following call for fire to a 155-mm battery using M485A2.

**P53 THIS IS P67, ADJUST FIRE, OVER.**

**GRID NB616376 ALTITUDE 105, OVER.**

**VEHICLE NOISES, SUSPECTED TANKS, ILLUMINATION, OVER.**

The first illuminating round bursts about 100 mils left of the suspected area and burns out 40 mils too high (measured with binoculars) (see figure 6-10). Using an observer-target factor of 2, the observer transmits the following:

**DIRECTION 5800, RIGHT 200, DOWN 100, OVER.**

(Deviation = 100 mils X 2 = 200 meters. HOB = 40 mils X 2 = 80 meters  $\approx$  100 meters.)

The second round bursts short near the observer-target line but is too low. It burns 6 seconds on the ground. The observer requests **ADD 400, UP 50, OVER** ( $6 \times 5 = 30 \approx 50$ ).

The third round bursts at the appropriate height over the suspected area. The observer identifies the target, waits until the target is best illuminated, and then transmits **ILLUMINATION MARK, OVER.**

The observer then proceeds into the coordinated illumination phase of the mission.

**COORDINATED ILLUMINATION, OVER.**

The next transmission after the observer calculates the enemy location is

**ADJUST FIRE, GRID NB621382, ALTITUDE 195, OVER.**

**2 TANKS AND A PLATOON OF INFANTRY, ICM IN EFFECT, OVER.**

The observer may also have sent the target location by polar plot (**ADJUST FIRE, POLAR, OVER**) or by shifting from the center of the illumination (**ADJUST FIRE, SHIFT, ILLUMINATION, OVER**).

For any illuminating round that in the observer's judgment provides maximum or enough illumination for the mission, the observer may transmit **ILLUMINATION MARK**. A separate marking round is a waste of ammunition.

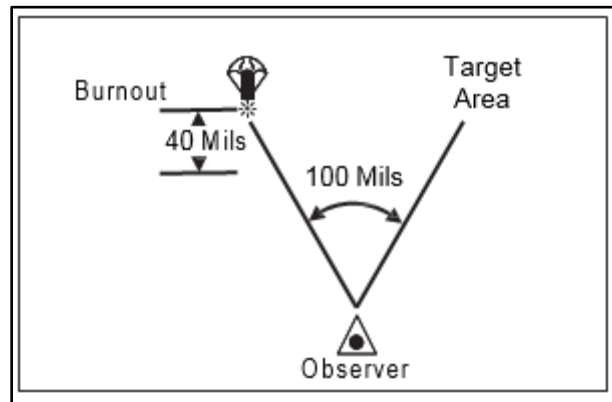

Figure 6-10. Initial illuminating round

## INFRARED ILLUMINATION

6-77. Infrared (IR) illumination provides illumination that is visible through night sights, but not to the naked eye. The 155-mm IR illumination round provides infrared illumination out to 17 kilometers for a minimum of 120 seconds.

6-78. The call for fire for IR illumination is very similar to regular illumination. Instead of requesting **ILLUMINATION**, the observer requests **IR ILLUMINATION**.

### Example

**P53 THIS IS P67, ADJUST FIRE, OVER.  
GRID NB616376, ALTITUDE 145, OVER.  
VEHICLE NOISES, SUSPECTED TANKS, IR ILLUMINATION, OVER.**

## CHARACTERISTICS OF SMOKE

6-79. When used correctly smoke can significantly reduce the threat's effectiveness both in daytime and at night. Use smoke to reduce the ability of the threat to deliver effective fires, to hamper hostile operations, and to deny the threat information on friendly positions and maneuvers. Smoke reduces the effectiveness of laser beams and inhibits electro optical systems including some night vision devices. The four types of smoke are:

- **Obscuring smoke** is placed on or near the threat to suppress threat observers and to minimize their vision (see figure 6-11).
- **Screening smoke** is a smoke curtain used on the battlefield between threat observation points and friendly units to mask friendly forces, positions, and activities (see figure 6-12 on page 6-21).
- **Deception smoke** is a smoke curtain used to deceive and confuse the threat as to the nature of friendly operations.
- **Signaling smoke** is used to establish a reference for friendly forces.

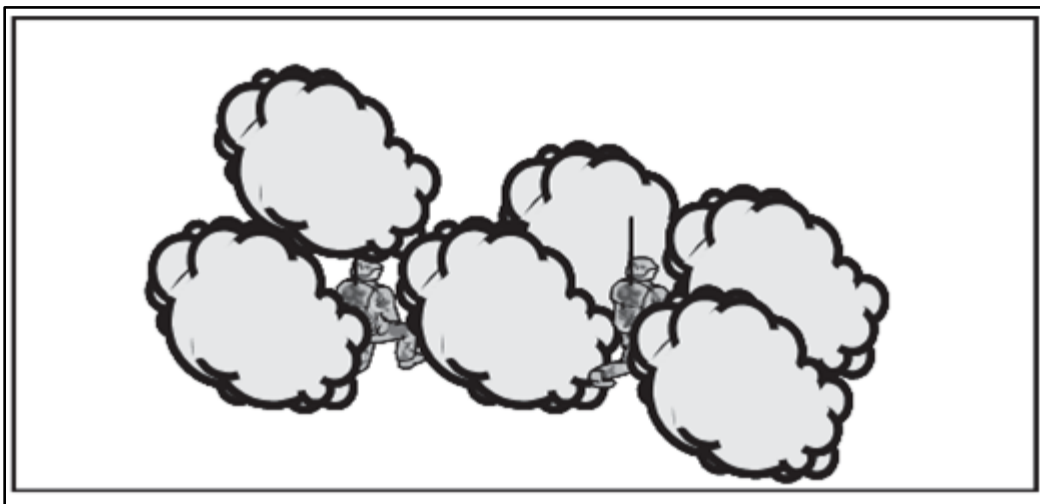
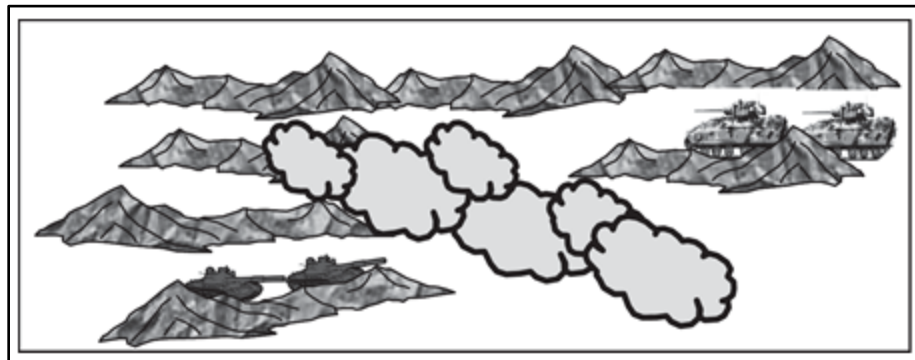

**Figure 6-11. Obscuring smoke**

6-80. Use obscuring smoke to:

- Defeat flash ranging and restrict the adversary's counterfire program.
- Obscure adversary observation posts and reduce their ability to provide accurate target location for adversary fire support assets.
- Obscure adversary direct fire weapons and lasers.

- Instill apprehension and increase threat patrolling.
- Slow adversary vehicles to blackout speeds.
- Increase control problems by preventing effective visual signals and increasing radio traffic.
- Defeat night observation devices and reduce the capability of most IR devices.



**Figure 6-12. Screening smoke**

6-81. Use screening smoke for:

- **Deceptive screens.** Smoke draws fire. Deceptive screens cause the threat to disperse his fires and expend his ammunition.
- **Flank screens.** Smoke may be used to screen exposed flanks.
- **Areas forward of the objective.** Smoke helps the maneuver units consolidate on the objective unhindered by threat ground observers.
- **Gap crossing operations.** Screening the primary crossing site denies the threat information. Deceptive screens deceive the threat as to the exact location of the main crossing.
- **Obstacle breaching.** The threat is denied the ability to observe breaching unit activities.

## SMOKE ROUNDS

6-82. Smoke rounds consist of two main categories which are mortars and artillery type rounds. The list below describe each of these types of smoke rounds.

### MORTARS

6-83. Mortar smoke includes white phosphorous (WP) and red phosphorus (RP) rounds.

#### Shell White Phosphorus

6-84. WP is available from 60-mm, 81-mm, and 120-mm mortars. Mortar WP produces rapid smoke buildup, but its effects are of limited duration. Due to the possible lethal effects of WP gas, consideration should be used when employing WP in the vicinity of friendly maneuver units and civilians to prevent fratricide or civilian casualties.

#### Shell Red Phosphorus

6-85. Fire coRP is a time fuzed round that contains RP smoke pellets. At a preset time along the round's trajectory, the fuze functions to expel and ignite the RP pellets at an approximate HOB of 175 meters. The burning pellets produce a cloud of dense smoke after hitting the ground. A three round volley is required to develop the basic smoke screen. RP smoke is available from 81-mm mortars only.

## ARTILLERY

6-86. Artillery smoke rounds includes white phosphorous, hexachloroethane-zinc, and improved smoke rounds.

### Shell White Phosphorus

6-87. WP has four uses: incendiary, marking, obscuring, and screening. It can be used to destroy the threat's equipment or to limit their vision. It builds quickly but has little sustainment. Due to the possible lethal effects of WP gas, consideration should be used when employing WP in the vicinity of friendly maneuver units and civilians to prevent fratricide or civilian casualties. It is normally used against—

- Vehicles.
- Petroleum and ammunition storage areas.
- Threat observers.

6-88. Use either point detonating or time fuzed WP as an aid in target location and navigation.

### Shell Hexachloroethane-Zinc

6-89. Hexachloroethane (HC) is time fuzed and functions at an HOB of approximately 50 meters. The projectile expels the HC smoke canisters to disperse them in the target area. Although HC smoke is slow building, it lasts longer and has less tendency to pillar. HC smoke has no casualty producing effects. This makes HC a more effective screening agent than WP. Due to the possible down-range risk of shell residue, consideration should be used when employing HC in the vicinity of friendly units and civilians.

### Shell M825 Improved Smoke

6-90. M825 is a canister filled with WP impregnated felt wedges that are expelled from the base of the projectile. It is time fuzed and functions at a predetermined HOB that varies with the propellant and charge fired. The wedges build rapidly into an effective screen with lasting duration.

6-91. Table 6-14 provides smoke planning data for artillery and mortars.

**Table 6-14. Smoke planning data (ATP 3-09.42)**

Delivery System	Type Round	Time to Build Effective Smoke (minutes)	Average Burning Time (minutes)	Average Obscuration Length (meters) Per Round	
				Wind Direction	
				Cross	Head or Tail
155-mm	WP	1/2	1 to 1 1/2	150	50
	HC	1 to 1 1/2	4	350	75
	M825	1/2	5 to 10	350	100 to 200
105-mm	WP	1/2	1 to 1 1/2	75	50
	HC	1 to 1 1/2	3	250	50
120-mm	WP	1/2	2 1/2	100	60
81-mm	WP	1/2	1	100	40
	RP	1/2	2 1/2	100	40
60-mm	WP	1/2	1	75	40
<b>Note.</b> All rounds are fired as standard missions with parallel sheafs under favorable conditions.					
<b>Legend:</b> HC—hexachloroethane      mm—millimeter      RP—red phosphorous      WP—white phosphorous					

## EMPLOYMENT CONSIDERATIONS

6-92. Factors to consider when employing smoke are weather, terrain, means available, ammunition, the threat, and mission command.





## WEATHER

6-93. Atmospheric stability, wind direction, and wind speed are the major factors influencing the effectiveness of smoke. Observers should be aware of effects on civilian populations or friendly units downwind before employing these munitions.

### Atmospheric Stability

6-94. The weather conditions, the time of day, and wind speed all affect atmospheric stability. The effects of atmospheric stability can determine whether smoke is effective or not and if effective, how much ammunition is needed. (See table 6-15 for temperature gradient effects on smoke.)

**Table 6-15. Temperature gradient effects on smoke**

<b>Time of Day and Weather Conditions</b>	<b>Smoke Conditions (Temperature Gradient)</b>	<b>Smoke Behavior (Wind Direction →)</b>
Night—until one hour after sunrise. Wind speed is less than 9 km per hour (5 knots). Cloud cover is less than 30%.	<b>IDEAL</b> (stable or inversion)	
Day—most often between one and two hours before and after sunrise. Wind speed is 9 km per hour (5 knots) or more. Cloud cover is 30% or more.	<b>FAVORABLE</b> (neutral)	
Day—beginning two hours after sunrise. Wind speed is less than 9 km per hour (5 knots). Cloud cover is less than 30%.	<b>MARGINAL</b> (unstable or lapse)	
<b>Note.</b> ideal, favorable, and marginal are smoke conditions. Stable, inversion, neutral, and lapse are temperature gradients.		
<b>Legend.</b> kph—kilometers per hour		

6-95. Temperature gradients are determined by comparing air temperatures at 0.5 meters and 4 meters. Stable, neutral, and unstable are the three general temperature gradients used.

6-96. Stable (or inversion) conditions exist when the air temperature increases with an increase in altitude. This condition greatly limits vertical air currents. Smoke produced during stable conditions lies low to the ground.

6-97. Neutral conditions exist when an increase in altitude is accompanied by little or no change in air temperature. Limited vertical air currents also cause neutral conditions when the wind speed is greater than 5 knots.

6-98. Unstable (or lapse) conditions exist when the air temperature decreases with an increase in altitude. Vertical air currents and turbulence characterize an unstable condition.

6-99. Under unstable conditions, HC and WP rounds are almost ineffective. The smoke does not spread but often climbs straight up in a pillar and quickly dissipates.

6-100. Under moderately unstable conditions, base ejecting smoke rounds are more effective than bursting WP rounds.

6-101. The higher the humidity, the better the screening effects of WP, RP, and HC rounds. Table 6-16 on page 6-24 compares the effectiveness of HC and WP to the relative humidity.

6-102. The observer can obtain detailed information and analysis of the meteorological conditions from the FDC.

**Table 6-16. HC and WP smoke effectiveness based on relative humidity**

<i>Relative Humidity</i>	<i>HC</i>	<i>WP</i>
<i>%</i>	<i>Effectiveness (percentage)</i>	<i>Effectiveness (percentage)</i>
0	100	100
10	146	353
20	152	372
30	159	391
40	173	411
50	189	434
60	211	465
70	240	510
80	325	588
90	572	785

**Legend.** HC—hexachloroethane      WP—white phosphorous

**Wind Speed**

6-103. The movement of smoke depends on the speed and direction of the wind. Wind speeds ranging from 4 to 14 knots are best for the production of smoke screens. Optimum speeds vary with the type of smoke used (see figure 6-13).

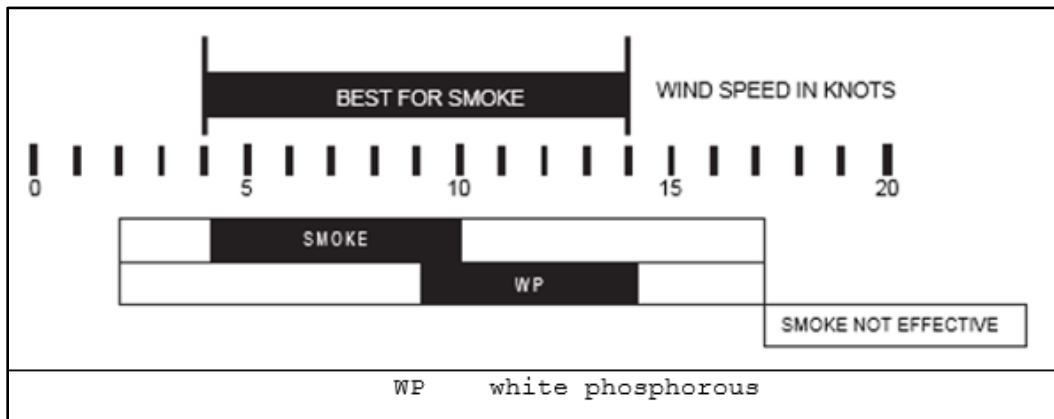

**Figure 6-13. Optimum wind speed chart**

6-104. To determine an approximate wind speed, the observer can use either the equivalent wind scale table (see table 6-17) or the grass drop (expedient) method. With the grass drop method, extend your arm downward and drop grass from your hand. Point your extended arm at the dropped grass on the ground. Divide the angle (in degrees) between your arm and your body by 4 to determine the approximate wind velocity in knots.

**Table 6-17. Equivalent wind scale for estimating wind speed**

<b>Knots</b>	<b>Observation</b>
1	Smoke, vapor from breath, or dust raised by vehicles or personnel rises vertically. There is no leaf movement.
1 to 3	Direction of wind slightly shown by smoke, vapor from breath, or dust raised by vehicles or personnel. There is slight intermittent movement of leaves.
4 to 6	Wind is slightly felt on face. Leaves rustle.
7 to 10	Leaves and twigs are in constant motion.
11 to 16	Wind raises dust from ground. Loose paper and small branches move.
17 to 21	Small trees with leaves sway. Coastal wavelets form on inland waters.
22 to 27	Large branches on trees are in motion. A whistle or hum is heard in telephone or fence wires.
28 to 33	Whole trees are in motion. Inconvenience is felt when walking against the wind.
<b>Note.</b> One knot equals 1.15 miles per hour	

### Wind Direction

6-105. Wind direction influences the desired location of smoke in the target area. To determine wind direction in the target area, observe drifting of smoke or dust, bending of grass or trees, and ripples on water. See figure 6-14 for classification of wind directions.

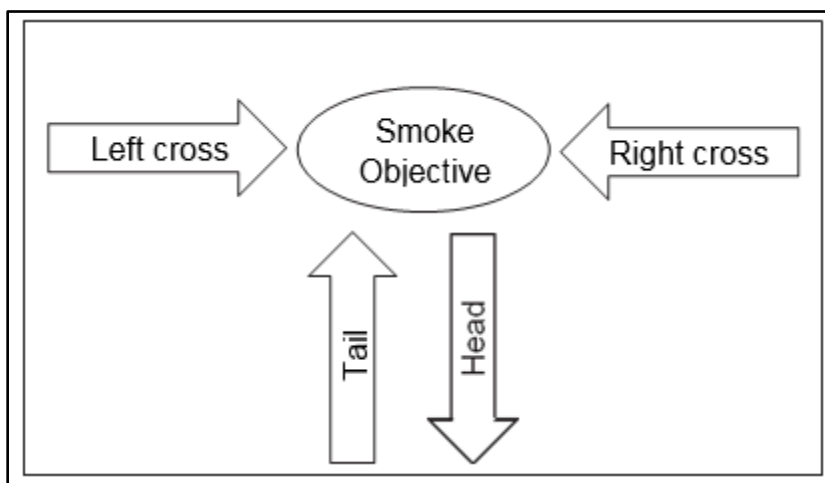
**Figure 6-14. Classification of wind directions**

### Maneuver-Target Line

6-106. Determine the wind direction (right or left cross, tail, or head) in relation to the maneuver-target line (MTL) (see figure 6-15 on page 6-26). The MTL is an imaginary line drawn from the maneuver unit's most vulnerable point along its route of march to the threat unit's observation point.

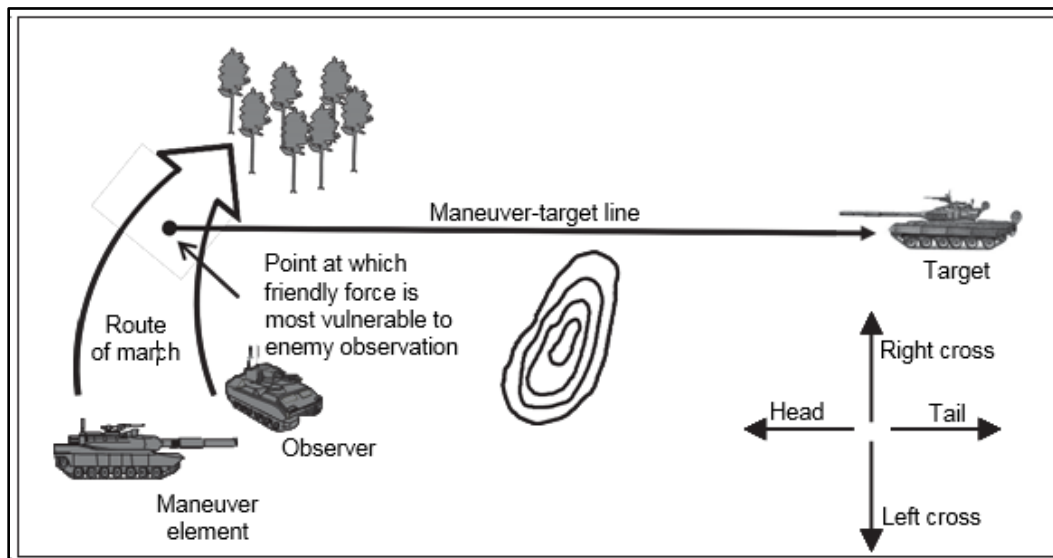

Figure 6-15. Maneuver-target line

**TERRAIN**

6-107. Winds follow the contours of terrain. The type of terrain over which smoke travels has a tremendous effect on how the smoke will cover a specific area. Flat, unbroken terrain creates effective smoke further downwind. Trees and small buildings tend to break up smoke, which may then reform to cover a larger area and create effective smoke at the source. Steep hills or mountains create volatile winds, usually resulting in gaps and uneven smoke. Slopes and valleys create thermal slope winds at different times. Heating effects during the day cause up slope winds. Cooling effects at night cause down slope winds.

6-108. If the ground in the target area is rain soaked or snow covered, burning smoke rounds may not be effective. During very cold and dry conditions or in areas with snow cover, up to four times the number of smoke rounds may be needed to create an effective screen.

6-109. Shallow water can reduce the smoke produced by base ejecting rounds by as much as 50 percent. Bursting WP rounds are not affected as much by terrain in the target area; however, deep snow and cold temperatures can reduce the smoke cloud by 25 percent.

6-110. Table 6-18 summarizes atmospheric and terrain effects on smoke operations.

**Table 6-18. Conditions for smoke employment**

<b>Factor</b>	<b>Marginal</b>	<b>Favorable</b>	<b>Ideal</b>
Wind	More than 10 knots	5 to 10 knots	Less than 5 knots
Atmospheric stability category	Unstable or lapse	Neutral	Stable or inversion
Humidity	Low	Moderate	High
Precipitation	None	Light rain	Mist or fog
Cloud cover	None	Scattered	Overcast, low ceiling
Terrain	Even	Gently rolling	Complex topography
Vegetation	Sparse or none (desert)	Sparse to medium dense	Medium to heavily dense
Time of day	Late morning through late afternoon	1 to 2 hours before and after sunrise	1 hour before EENT to one hour before BMNT
<b>Legend.</b> BMNT—before morning nautical twilight      EENT—ending evening nautical twilight			

## MEANS AVAILABLE

6-111. Before requesting a smoke mission, the observer and FSO must consider the means available. The FSO advises the supported commander on the best means of providing the smoke to accomplish the task. The FSO also provides tactical information that could affect the fire support available.

## AMMUNITION

6-112. The amount of smoke ammunition in basic loads is limited. Expenditures of smoke ammunition vary considerably with each specific mission. All observers must know the amount of ammunition available and how much smoke it will provide expressed in terms of length and duration. Large requirements for smoke may require redistribution of the basic loads of several units or an issue of additional smoke ammunition for a specific operation. Combat experience has shown that smoke ammunition will not be available to support all smoke requests.

## THREAT

6-113. When considering smoke employment, the threat's electro optical capability and the likely positions for their weapons systems and observers that may threaten friendly forces should be known or anticipated. Based on the commander's plan, observers and FSOs should determine when smoke employment would enhance friendly operations and hinder threat operations. Some general rules are:

- Fire smoke on threat artillery observation post and gunners to greatly reduce their effectiveness.
- Fire smoke and HE on the threat when deploying from column to line formation. The HE will keep the enemy buttoned up. The smoke will cause maximum confusion.
- Fire smoke and HE on minefield to cause maximum confusion. (Avoid concealing threat breaching operations.)
- Understand the effects of smoke on friendly positions. Smoke used without enough thought and planning reduces the user's effectiveness more than that of the threat.

## MISSION COMMAND

6-114. The supported commander for whom the smoke is planned must approve its use. When the commander issues the plans and concept for an operation, the commander should state guidelines on the amount of smoke to use and any restriction on its use. To ensure responsive smoke, the FSO must request this smoke planning guidance if it has not been stated. The supported commander responsible for the operation must coordinate smoke operations with all units participating in or potentially affected by the operation. The operations officer is responsible for integrating smoke into the maneuver plan. The FSO must keep the supported commander advised on the availability of munitions and delivery systems. Soldiers must be well trained in smoke operations and comprehensive unit SOPs must be available to and known by all. This shortens reaction time.

## SMOKE DELIVERY TECHNIQUES

6-115. Smoke is normally employed by use of immediate smoke and quick smoke techniques. The objective of immediate smoke is to obscure the threat's vision. Suppression of a small location can be achieved by use of immediate smoke. The objective of quick smoke is to **obscure** the threat's vision or to **screen** maneuver elements. Obscuring the threat is required, but the urgency of the situation does not dictate immediate smoke procedures. Generally speaking, quick smoke missions are almost always planned missions whereas immediate smoke missions are generally targets of opportunity. Characteristics of the two delivery techniques are outlined in table 6-19 (on page 6-28).

---

*Note.* The use of immediate and quick smoke techniques does not preclude the use of smoke on other occasions or for different objectives.

---

Table 6-19. Smoke delivery techniques

<i>Delivery Technique: Immediate smoke<sup>1</sup> (point or suppression)</i>	<i>Type of Target</i>	<i>Type of Ammunition</i>	<i>Sheaf</i>	<i>Obscuration Time (minutes)</i>	<i>Mission Command</i>
<i>Field Artillery</i>	Point or small area 150 meters or less <sup>2</sup>	First rounds WP or smoke; second rounds smoke	AFATDS	1/2 to 5	By SOP or supported commander's approval
<i>Mortar</i>		3 rounds (each) RP 2 rounds (each) WP	Parallel	1 to 3	By SOP or supported commander's approval
<i>Delivery Technique: Quick smoke (small area or suppression)</i>	<i>Type of Target</i>	<i>Type of Ammunition</i>	<i>Sheaf</i>	<i>Obscuration Time (minutes)</i>	<i>Mission Command</i>
<i>Field Artillery</i>	Small area 150 to 600 meters	Smoke or WP	AFATDS	4 to 15	Approval of supported commander
<i>Mortar</i>		WP, RP	Parallel, open or special (as required)	4 to 15 depending on ammunition availability	Approval of supported commander
<b>Note.</b> <sup>1</sup> The immediate smoke technique can be used in an immediate suppression mission on a target of opportunity. By unit SOP, a mix of WP and smoke normally will follow the initial suppression rounds when immediate smoke is requested. <sup>2</sup> For larger areas, consider multiple aiming points and the use of the quick smoke technique.					
<b>Legend.</b> AFATDS—Advanced Field Artillery Tactical Data System mm—millimeters SOP—standing operation procedure RP—red phosphorous WP – white phosphorous					

## IMMEDIATE SMOKE

6-116. The immediate smoke technique can be used in an immediate suppression mission on a target of opportunity, depending on unit SOP, a mix of WP and smoke normally will follow the initial suppression rounds when immediate smoke is requested.

### DESCRIPTION

6-117. Use immediate smoke to obscure the threat's vision. Use immediate smoke in conjunction with other suppressive fires, or use it after immediate suppressive fire. If immediate suppressive fire is ineffective because of inaccurate target location, the observer has the option of giving a bold shift and requesting that smoke be fired.

**Example**

H18 THIS IS H24, IMMEDIATE SUPPRESSION, GRID NK439892 ALTITUDE 125, OVER.  
 (Suppression was ineffective and the observer wishes to use smoke instead.)  
 DIRECTION 5300, LEFT 300, DROP 200, IMMEDIATE SMOKE OVER.

**EMPLOYMENT CONSIDERATIONS**

6-118. Before firing immediate smoke, the observer must realize that suppression by smoke will not be as immediate as suppression by HE, since it takes time for the smoke to build up. Inaccurately placed smoke may still provide obscuration, whereas inaccurately placed HE may not give the desired results. Although immediate smoke will provide suppression (by obscuration) for a longer time than HE, it is effective only against a pinpoint target or a small area target less than 150 meters in diameter.

6-119. The unit SOP should specify the type of ammunition to be fired. A suggested mix is firing WP (for initial quick buildup) and firing HC (for duration). Once the smoke has built up, all subsequent volleys should be shell smoke.

6-120. Normally, use immediate smoke on a planned suppressive target. The observer can also use it when immediate suppression with HE is ineffective. Corrections for deviation, range, and HOB may be required.

6-121. When firing a mixture of smoke and WP, it will normally be effective 30 seconds after the rounds impact and will last about 4 to 5 minutes. If the smoke is required for a longer period, request additional volleys of smoke. The adjusting point for immediate smoke is the target itself.

**QUICK SMOKE**

6-122. This method of employing smoke is more deliberate than immediate smoke. The observer will take into account the maneuver target line.

**DESCRIPTION**

6-123. Use quick smoke to obscure the threat's vision or to screen maneuver elements. Begin the mission by adjusting with HE, request smoke once the 200 meter bracket is split to verify smoke placement and conditions, and then fire for effect with desired smoke.

**EMPLOYMENT CONSIDERATIONS**

6-124. Use the quick smoke mission to obscure areas from 150 meters up to 600 meters wide. For areas larger than 600 meters, the observer can fire multiple quick smoke missions. Smoke may be effective up to 1,500 meters downwind.

6-125. When preparing a quick smoke mission, the observer first determines the nature of the target and the location of the adjusting point. Then determines the size of the area and the wind direction in relation to the MTL (see Figure 6-15 on page 6-26).

6-126. Inform the FDC of the target length, MTL, wind direction, and the length of time the smoke is required. This information is sent to the FDC as early as possible usually in the third transmission of the call for fire. The observer uses the acronym LMDirT to remember the required information. If not included in the initial call for fire, it must be sent prior to requesting fire for effect. The observer also has the option of extending the time of effective smoke by requesting subsequent volleys. See TC 3-09.81 for additional quick smoke data.

6-127. If the smoke must be effective beginning at a specific time, the observer requests **AT MY COMMAND** and the time of flight. To determine when to order the smoke fired, the observer adds the time of flight to the average buildup time of 30 seconds for WP and 60 seconds for smoke.

6-128. If the smoke is ineffective, the observer must decide whether to shift the smoke or to fire HE. If the decision is to shift, there may be a break in the screen while new data is computed.

### ADJUSTMENT

6-129. Adjustment may be required to bring the desired effects on to the target. Observers need to judge wind speed and direction in the target area to make corrections. The minimum corrections are 50 meters for deviation and 100 meters for range. The HOB of shell smoke (M116A1) can be adjusted for—

- Ground burst: **UP 100.**
- Canisters bouncing excessively: **UP 50.**
- Canisters too spread out: **DOWN 50.**

### Shell Smoke (HC)

6-130. Use HE in adjustment until a 200 meter bracket is split. The observer then requests shell smoke. Fire one smoke round, and make any necessary corrections. Then request fire for effect.

### Shell WP

6-131. This adjustment is conducted like an adjust fire mission with WP in effect. Use HE during the adjustment. The observer may fire a WP round after adjusting with HE in order to verify wind condition and smoke placement prior to firing WP in effect.

### Improved Smoke (M825)

6-132. This is the predominant 155-mm smoke round. Adjust M825 smoke in the same manner as HC smoke. However, M825 improved smoke rarely requires HOB corrections. If the observer spots the M825 as graze, immediately announce “graze” to the FDC. The FDC must then verify the firing data was correct. The HOB of M825 can be adjusted by;

- Graze burst with correct firing data: **UP 100**
- Thick, dense separated clouds: **UP 50**
- Thin, uneven clouds; **DOWN 50**

### EXAMPLE MISSIONS

6-133. The examples below portray various types of smoke missions.



**Example**

Immediate smoke as a continuation of an immediate suppression mission

**DIRECTION 5600, RIGHT 200, ADD 400, IMMEDIATE SMOKE, REPEAT OVER.**

**Note.** Direction is given if it was not sent previously in an immediate suppression mission.

Example. Immediate smoke as the initial call for fire.

**H18 THIS IS H24, IMMEDIATE SMOKE, GRID NK628543 ALTITUDE 295, OVER.**

**Example (Quick Smoke)**

**H18, THIS IS H24, ADJUST FIRE, SHIFT KNOWN POINT 1, OVER.**

**DIRECTION 2400, RIGHT 100, ADD 200, OVER.**

**SUSPECTED PLATOON LOCATION, LENGTH 200, MTL 2700, TAIL, DURATION 5 MINUTES, SMOKE IN EFFECT, OVER.**

or

**H18 THIS IS H24, ADJUST FIRE, OVER.**

**GRID NK432895 ALTITUDE 105, OVER.**

**SCREEN TREE LINE, LENGTH 200.**

**MTL 1800, LEFT CROSS, DURATION 8 MINUTES, SMOKE IN EFFECT, OVER.**

**Example (Quick Smoke, Multiple Aiming Points)**

The observer fires a quick smoke mission, observes effects, and announces to the

**FDC SECOND AIMING POINT, RIGHT 500, DROP 200, REPEAT, OVER.**

**Note.** Had the observer simply wanted to move the quick smoke to another point, he would have made a normal subsequent correction and said **RIGHT 500, DROP 200, REPEAT, OVER.**

The second aiming point tells the FDC that the observer wants to fire on a second point at this time and that the battery should be prepared to replenish smoke on either point. By observing how long the smoke remains effective near either aiming point, the observer can determine a time interval at which to replenish his smoke should he want to do so.

Interval = effective screen time – build up time.

He can pass this information to the FDC by sending **CONTINUE SMOKE AT 3 MINUTES INTERVALS FOR 15 MINUTES, OVER.**

**Example (Quick Smoke, Multiple Aiming Points Called For At The Beginning Of The Mission)**

**H18 THIS IS H24, FIRE FOR EFFECT, OVER.**

**GRID NK 843321 ALTITUDE 190 AND GRID NK840322 ALTITUDE 185, OVER.**

**TRENCH LINE, LENGTH 800, RIGHT CROSS, DURATION 12 MINUTES, SMOKE, OVER.**

**MORTAR PROCEDURES**

6-134. When using mortars for quick smoke attitude of the desired smoke screen should be included in addition to Maneuver Target Line, as MTL cannot be input into the Lightweight Handheld Mortar Ballistic Computer (also called LHMBC).

- If the WP rounds do not impact on or near the selected aimpoint, the observer makes corrections as necessary. The observer may send deviation corrections for individual tubes to the FDC.
- When using 81-mm WP, the observer may select a second aiming point halfway between the target and the first aiming point, and may use the second aiming point to supplement firing on the first aiming point or to shift fires quickly if the initial smoke is ineffective.

6-135. The observer can correct the rate of fire, deviation for individual mortars, or for the entire section after the fire for effect.

## Chapter 7

# Observer Special Missions

This chapter provides guidance on missions requiring special procedures for the observer.

### FIRES FOR PILOTS

7-1. If possible, the battalion fire support officer (FSO) and the supported unit operations staff officer or intelligence staff officer should give the pilot a detailed preflight briefing. The preflight briefing should cover the following:

- The tactical situation to include threat locations and antiaircraft weapons, friendly locations and capabilities, front lines, zones of action of support troops, and all coordinating measures.
- The location of all indirect fire units, known points, targets, search areas, and ordnance available.
- Flight instructions, time on and off the mission, obstacles, checkpoints, and equipment needed.
- Communications details such as frequencies, call signs, check in time, and prearranged signals.
- Any unit standard operating procedure items regarding registrations, immediate suppressions, special munitions, and suppression of enemy air defenses.
- Fire Support Coordination Measures including: No Fire Zones, No Fire Areas, or No Fire Lines.
- Latest Rules of Engagement concerning civilians and non-combatants in the area of operations. Pilots need to exercise restraint and use professional judgment if in the event target information at time of execution is not correct. If targets are compromised, the pilot needs to plan for alternative means of mission accomplishment and exercising judicious use of lethal force.

7-2. After verbally briefing the pilot, one technique for the FSO to consider is to provide the pilot with a knee board sized copy of key fire support information as illustrated in table 7-1.

**Table 7-1. Fire Support information for pilots**

<i><b>Call for Fire</b></i>			
FM Net Primary: FSCM:	Alternate:	Fires Cell Call Sign:	
<i><b>Friendly Artillery Positions</b></i>			
Field Artillery Bn:	Bn Mortars:		
Field Artillery Bn:	Bn Mortars:		
Field Artillery Bn:	Bn Mortars:		
Field Artillery Bn:	NSFS:		
<i><b>CAS Available</b></i>			
Type:	Time:	Call Sign:	Frequency:
IP:	Abort Code:	Laser Code:	
<b>Legend.</b> CAS—close air support FSCM—fire support coordination measure		Bn—battalion IP—Initial Point	FM—frequency modulation NSFS—Naval Surface Fire Support

## SPOTTING LINE

7-3. The spotting line is the line along which the observer is going to adjust. The fire direction center (FDC) personnel must know the spotting line and its direction. There are several methods used for spotting (see figure 7-1). They are:

- Gun-target line, based on knowledge of guns location.
- Observer-target line, based on aircraft heading indicator.
- Cardinal direction.

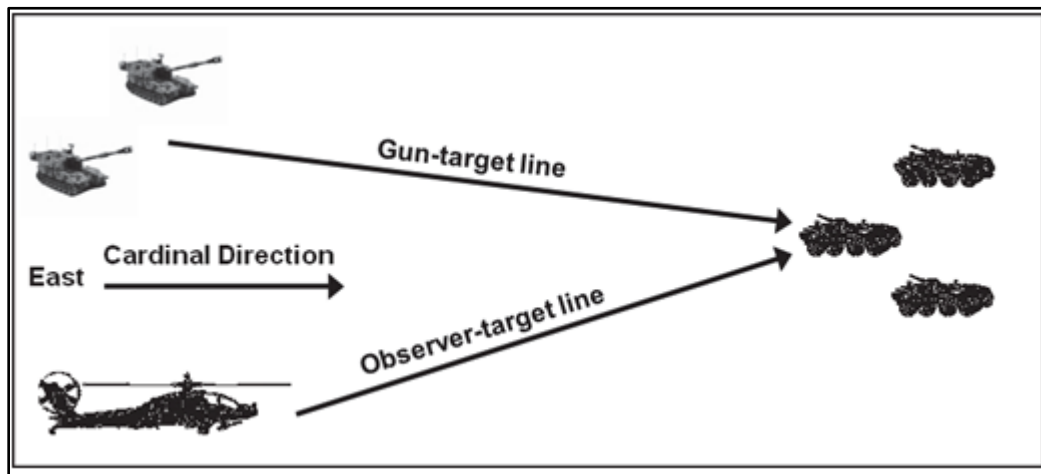

Figure 7-1. Observer- target line, gun-target line and cardinal direction

## GUN-TARGET LINE

7-4. Knowledge of the firing unit location allows the observer to determine the gun-target line. This allows the pilot to offset the aircraft away from the gun-target line to prevent fratricide.

## OBSERVER-TARGET LINE

7-5. Use the aircraft heading indicator to determine the observer-target direction. Since the aircraft is normally in a head on posture when the observer is looking at the target, the heading indicator will provide an accurate direction in most cases. When this technique is used, send direction to the nearest 10 degrees, for example, **DIRECTION 070 DEGREES MAGNETIC** (or **GRID**). If the observer-target direction changes more than 10 degrees during a mission, send the new direction to the FDC (send subsequent corrections using the new observer-target line). This is the preferred method, as it minimizes observer reorientation and exposure time while maximizing aircraft maneuverability.

## CARDINAL DIRECTION

7-6. The observer may use cardinal direction for sending orientation. This is the least accurate method and therefore the least preferred.

## TARGET LOCATION

7-7. Without aircraft laser devices, obtaining accurate target location is difficult since targets are normally acquired with the naked eye. Use of binoculars is limited because of distortion caused by the windscreen and vibration of the aircraft. Use hand measurements or estimations to measure angular deviation. Indicate target location by grid or by shift from a known point.

7-8. Aircraft lasers provide pilots with the ability to obtain fast and accurate target locations (see figure 7-2). Lasers on the AH-64 Apache and OH-58 Kiowa Warrior, for example, enable pilots to determine an eight digit grid to a target. These laser systems have embedded GPS which reduces TLE. As a result, the most common call for fire originating from Army aircraft is a fire for effect grid mission.

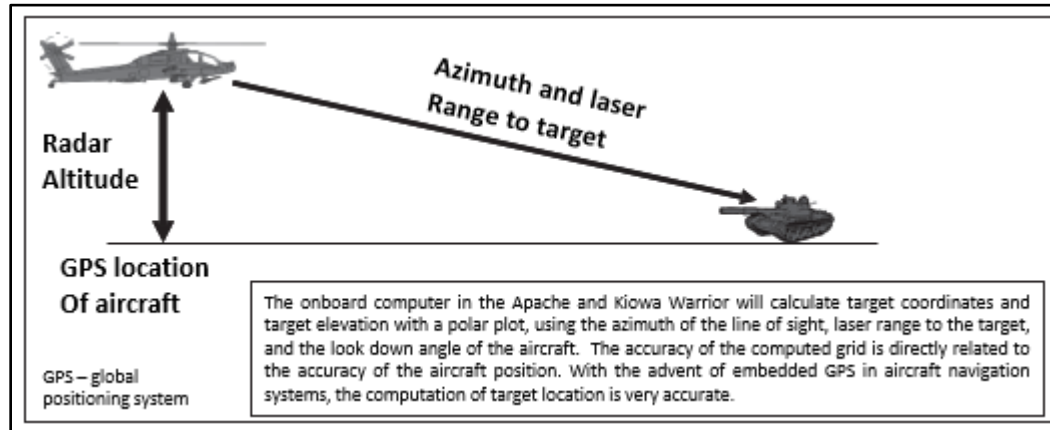

Figure 7-2. Aircraft target location

### ADJUST FIRE TECHNIQUES

7-9. When adjusting fire, the observer will usually use either the stationary hover or the pop up technique. In stationary hover, the pilot positions the aircraft behind trees or other terrain features that conceal the aircraft and still permit observation of the target.

7-10. In pop up, the pilot unmask the aircraft two to three seconds before impact of the round. The observer observes the burst and the pilot then returns the aircraft to the hide position or moves to another hide position. The observer sends corrections as the pilot is remasking the aircraft. Time of flight is automatically sent to the observer. This allows the pilot to position the aircraft properly if splash time is not sufficient. Avoid set patterns of movement to enhance survivability.

7-11. After the fire mission is sent, the FDC will determine firing data to the target. They will send a MTO to the pilot or observer in aircraft to inform them how the firing unit will attack the target. The MTO will include the time of flight for the rounds since the call for fire originates from a pilot or observer in an aircraft. When the firing unit fires the initial round, the FDC sends the pilot or observer in aircraft **SHOT** to announce that the unit fired. Then, based on time of flight of the rounds the FDC will send **SPLASH** to inform the pilot or observer in aircraft when the rounds impact. The FDC must send **SPLASH** to the pilot or observer in aircraft since the sound in the aircraft precludes the pilot from hearing the impact.

### OBSERVED FIRES WITH UAS

7-12. The Observer can call for and adjust fire utilizing an Unmanned Aircraft System (UAS). This can enhance the observer's ability to acquire targets from above with a remote viewing system. This process is similar to conducting fires with manned aircraft. The observer must establish an OT line (GTL, a predetermined azimuth, or direction from a known point on the ground) prior to making any corrections.

### HIGH-ANGLE FIRE

7-13. Situations requiring high angle fire include when the weapons fire out of a deep defilade, from within built up areas, or over high terrain features near friendly troops. Targets located on a reverse slope, in jungles, in deep gullies or ravines, or in other areas unreachable by the flatter trajectory of low angle fire usually require high-angle fire (see figure 7-3 on page 7-4).

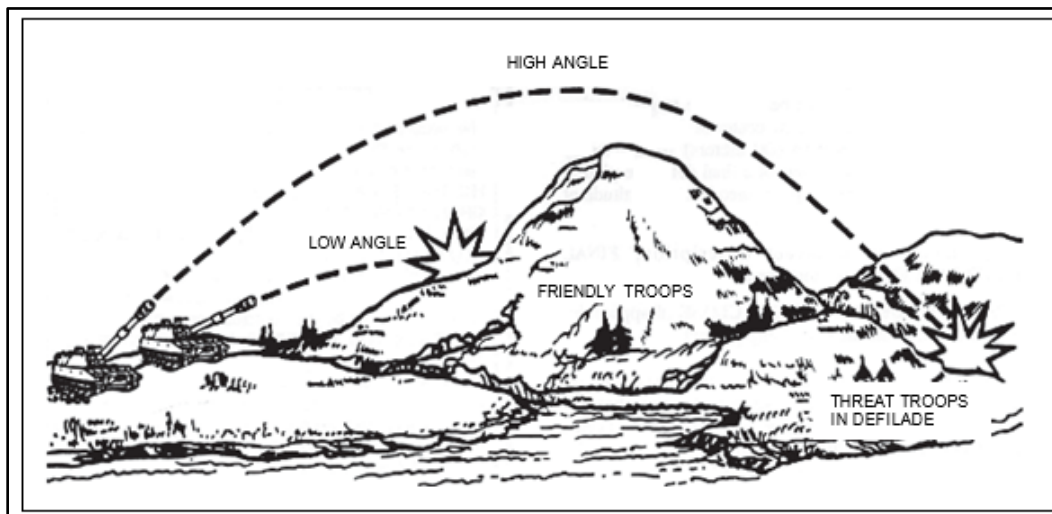

**Figure 7-3. High angle fire**

7-14. Generally, those weapons with a maximum elevation substantially in excess of 800 mils can fire high angle. All Army field artillery weapons are capable of low and high angle fires. Mortars are capable of only high angle fire. Naval guns are high muzzle velocity, flat trajectory weapons systems and are not suitable for high-angle fire.

7-15. The observer procedure for the adjustment of high-angle fire is the same as that for the adjustment of low angle fire. The observer must realize that small deviation corrections during adjustment may be unnecessary and time consuming because of the increased dispersion during high-angle fire. Since the time of flight is long in the adjustment and fire for effect, the FDC should announce **SHOT** and **SPLASH**. If an airburst is desired, fuze VT gives excellent results.

## FINAL PROTECTIVE FIRE

7-16. A final protective fire (FPF) is an immediately available prearranged barrier of fire designed to impede enemy movement across defensive lines or areas. The commander can only assign a single FPF to each firing unit, typically a battery or platoon. An FPF is a priority target for an element or system, and those fire units are laid on that target when they are not engaged in other fire missions. When the threat initiates the final assault into a defensive position, the defending unit initiates its FPFs to kill threat infantry soldiers and suppress armored vehicles. The size of the FPF depends on the number and type of weapons firing. Refer to JP 3-09.3 for more information regarding FPF.

7-17. The supported commander designates the location of the FPF. Plan the FPF to support a defense and integrate the FPF into the final protective line of the maneuver unit. The FPF may be any distance from the friendly position, but is normally within 200 to 400 meters (danger close) of friendly positions. The importance of accurate defensive fires and the danger close situation require that each weapon firing the FPF be adjusted into place, if possible.

## PROCEDURES

7-18. The FPF can be adjusted or non-adjusted. Considerations include the tactical implications of adjusting the FPF (loss of surprise) versus the accuracy required for firing close to friendly troops.

## MANUAL FDC

7-19. When an FPF with a manual FDC is established, the call for fire is similar to the normal call for fire in an adjust fire mission with the following exceptions:

- If adjusting the FPF, the initial target location sent is not the location of the center of the FPF but a grid that is a safe distance (400 to 600 meters depending on the weapon system) from friendly troops. Encode the grid or send it by secure means because it is part of a final defensive plan.
- Instead of a target description, announce **FINAL PROTECTIVE FIRES**.
- Announce **ATTITUDE** and **DANGER CLOSE** (if applicable) in method of engagement.

7-20. Fuze delay reduces the danger area from fragmentation. Adjusting with fuze delay minimizes the safety hazard to friendly units.

7-21. The firing unit will fire a battery or platoon (mortar platoon) right (or left) one volley at a five second interval, or as specified by SOP, centered on the initial grid sent by the observer. For example, assume that the rounds impact as shown in figure 7-4. The observer begins the adjustment with the flank piece impacting closest to the FPF line (in this case, number 1). Creeping fire adjustment procedures must be used in danger close situations. The observer adjusts the round to within 50 meters, sends refinement and announces the piece is adjusted. For example, **NUMBER 1, RIGHT 20, DROP 25, NUMBER 1 IS ADJUSTED**.

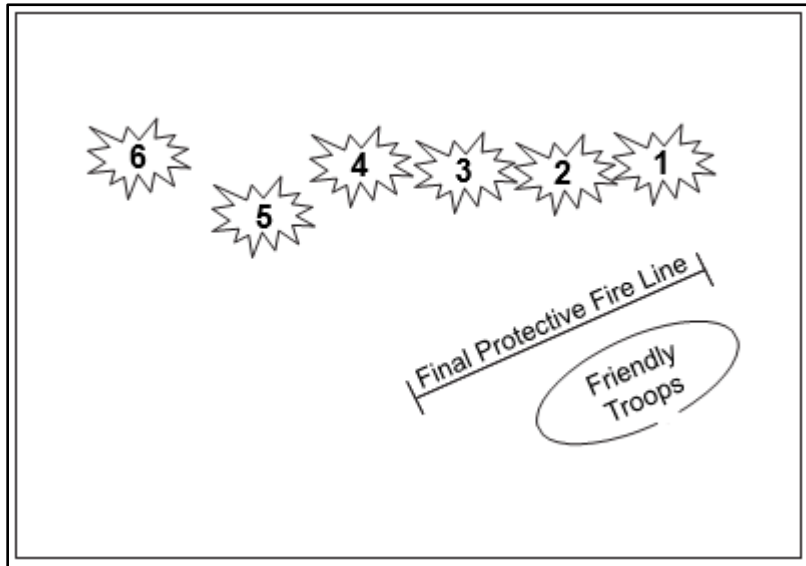

**Figure 7-4. Adjustment of the FPF begins with the flank piece round closest to the FPF line (number 1)**

7-22. Once the first gun is adjusted, the observer sends **NUMBER 2, REPEAT** and adjusts each weapon in succession.

### Example

The weapons firing are a 105-mm battery (six guns in this case). The supported commander shows the observer where to place the FPF. The observer sends the following call for fire:

**H12 THIS IS H18, ADJUST FIRE, OVER.**

**GRID NK123456 ALTITUDE 105.**

**FINAL PROTECTIVE FIRE, ATTITUDE 1900, DANGER CLOSE, DELAY, OVER.**

The battery fires a battery one round. The sheaf is shown in figure 7-5. The observer notes that howitzer number 6 impacted closest to the FPF line, and begins the adjustment with it:

**DIRECTION 0810, NUMBER 6, LEFT 100, DROP 50, OVER.**

The round is fired and the observer believes that the round is within 50 meters, and sends a correction (the round is not fired) and calls for number 5 to fire:

**NUMBER 6, DROP 25, NUMBER 6 IS ADJUSTED.**

**NUMBER 5, REPEAT, OVER.**

7-23. Adjust the other weapons as previously discussed.

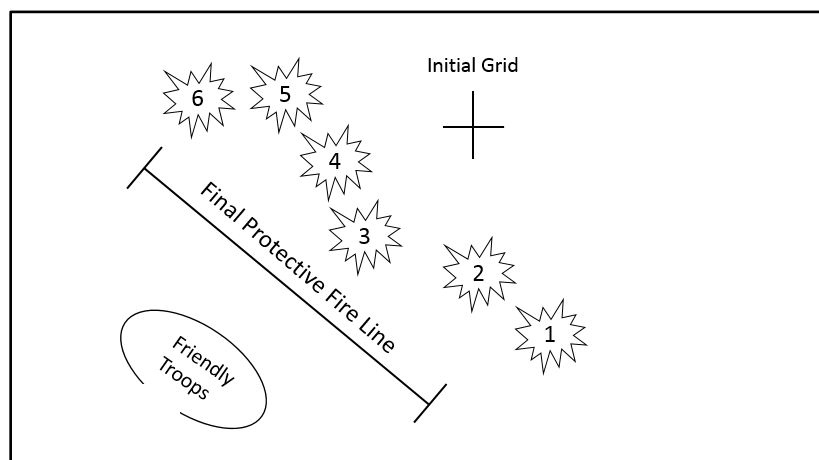

**Figure 7-5. Adjustment of the FPF begins with the flank piece round closest to the FPF line (number 6)**

### AUTOMATED FDC

7-24. The observer adjusts only the center weapon onto the center grid of the FPF when adjusting for an automated FDC that uses muzzle velocity variations and special corrections.

### NON-ADJUSTED FPFs

7-25. In some instances, the tactical situation dictates against adjusting the FPF. In these cases, give the dimensions of the FPF in the call for fire. The locations can be sent using:

- Grids to the two endpoints.
- The center grid and attitude.
- Length, width, and attitude.
- Laser draw. (see para 7-33)



## MULTIPLE MISSIONS

7-26. Contact with the threat may be so intense that the observer must transmit two or more calls for fire and adjust all missions simultaneously. The observer should consult the supported commander, if possible, or use own best judgment to determine which of several important targets to engage first. Once a target number is assigned, the observer should begin each correction with the observer identification, followed by the target number, and ending with the desired correction. For example, **ROMEO 12 THIS IS JULIET 73, TARGET NUMBER AB2010, LEFT 50, ADD 200, OVER.**

7-27. The observer tracks multiple missions by their target numbers and records the corrections determined for each target to eliminate any confusion that may arise in the heat of battle.

## AUXILIARY ADJUSTING POINT

7-28. To achieve surprise, the observer may decide not to adjust directly on the target but to adjust on a nearby point. This nearby point is called the auxiliary adjusting point (see figure 7-6). An auxiliary adjusting point must be far enough from the target (500 meters) to obscure the real purpose of the adjustment. The observer must also select an auxiliary adjusting point that facilitates an easy and accurate (preferably lateral) shift to the target. Once the adjustment on the auxiliary adjusting point is complete, fires are shifted to the target.

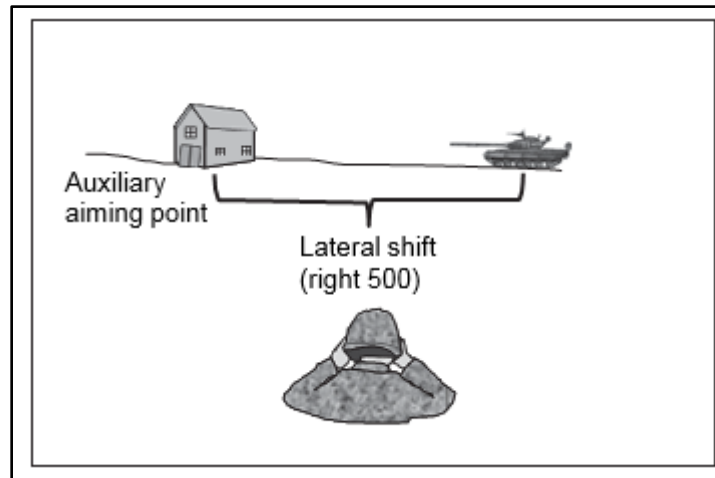

Figure 7-6. Auxiliary adjusting point

## OBSERVER NOT ORIENTED

7-29. Poor visibility, unreliable maps, deceptive terrain, or rapid movement through unfamiliar terrain sometimes makes it difficult for the observer to orient oneself. The observer may call for a marking round to be fired on a known point, a previously fired target, or a prominent terrain feature (for example, **MARK KNOWN POINT 1** or **MARK HILL 37**). As a last resort, the observer may call for a round to be fired into the center of the target area (for example, **MARK CENTER OF SECTOR**). The observer usually requests a type of projectile that is easily identifiable (such as WP) or a high airburst or both. (The unit may have an SOP for shell fuze combination.) The FDC prepares data that will place the round at the point requested by the observer. If the observer fails to see the round, the FDC prepares data that will move the next round to a different point of impact or that will raise the burst higher in the air. Continue this procedure until the observer positively identifies the round, then orders a shift from the point of impact (burst) of the identified round to a target or an object that is permanent or semi-permanent in nature, such as a road junction or the ruins of a building. Once the observer locates this point by adjustment of fire and the FDC plots the point, the observer may use it as a known point from which to make future shifts to subsequent targets.

## IRREGULARLY SHAPED TARGET

7-30. When calling for fire on an irregularly shaped target, the observer must request the appropriate sheaf or describe the target in sufficient detail to allow the fire direction officer to decide how to best attack the target. Choices include circular, linear, rectangular and laser drawn targets. For targets that warrant multiple batteries or battalions, segment the target so that batteries provide coverage for a portion of the target.

### CIRCULAR SHEAFS

7-31. Circular sheafs may provide the best coverage of an irregular target area. The circular sheaf is the default sheaf as discussed in Chapter 4.

### LINEAR AND RECTANGULAR TARGETS

7-32. Linear and rectangular targets require orientation in terms of direction. The observer sends the grid, size, and attitude of the target. The grid is the location of the center of the target. The size is the length and width of the target. The target attitude is described as a clockwise angle, in mils, measured from grid north to a line passing through the long axis of the target (see figure 7-7). Send attitude (always less than 3200 mils) to the nearest 100 mils.

**Example**  
**E12 THIS IS E22, FIRE FOR EFFECT, OVER.**  
**GRID NK847751 ALTITUDE 265, OVER.**  
**INFANTRY PLATOON IN TRENCH LINE, 50 x 200, ATTITUDE 2600, VT, OVER.**

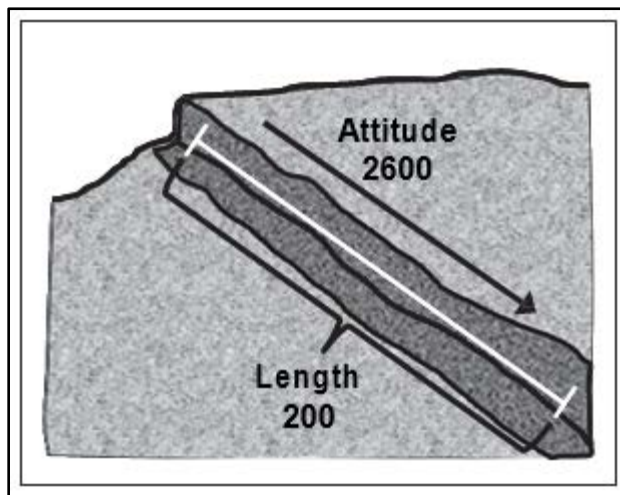

Figure 7-7. Target attitude

### LASER DRAWN TARGETS

7-33. For an irregularly shaped target, the observer may send polar data to multiple points "drawn" or traced on the target and identify these points to the FDC as a laser draw.

## ADJUSTMENT BY SOUND

7-34. If observer's visibility is limited, adjusting fires by the use of sound may be used. The target location may be reported to the observer by the supported unit or the observer may determine it. If the observer can hear noises at the threat position (for example, weapons firing, vehicle or troop movement), the observer can estimate a direction and a distance from the friendly position. The observer must alert the FDC when adjusting by sound.

7-35. Upon hearing the burst of the adjusting round, the observer estimates the direction to the burst and compares it with the direction to the target, then converts the deviation to a lateral shift, in meters (using estimated range to the target). Distance to the adjusting point is difficult to judge; therefore, the observer may have to use a creeping technique to adjust onto the target. The observer can determine distance by measuring the time it takes for the sound to be heard and multiplying the time interval by the speed of sound (350 meters per second). To help the observer determine distance accurately, the FDC must announce the precise moment of impact.

7-36. The observer must use caution in very broken terrain. In hills and mountains, the sound may travel around a hill mass before it arrives at the observer's position and may produce a false direction to the burst.

This page intentionally left blank.

## Appendix A

# Observer Self-location Methods

The observer can obtain an initial location by map-spot and compass, however, should refine the observation post location and the orientation of the laser rangefinder with more accurate means as soon as possible. If possible, observer location should be determined by survey. Lacking survey control, however, the observer has a variety of techniques available to self-locate. An observer should always use the most accurate means of self-location available that the situation permits. Observer coordinates (also called OBCO) should be sent to higher headquarters and the FDC (when in direct support) as set in unit SOP. It is recommended that this be no less than every 15 minutes or 500 meters travelled while patrolling. When in a static OP, location is sent upon initial establishment of the OP and needs to only be sent again if there is refinement to the initial grid or if the OP is moved.

### SELF-LOCATION BY USE OF TWO KNOWN POINTS

A-1. The observer sends to the FDC the direction, distance, and vertical angle to two known points separated by at least 300 mils, and must also specify which known point is on the left. The FDC determines the laser rangefinder location. Then the FDC determines the correct orienting azimuth to one of the known points. This information is sent through secure means to the observer. The observer then plots their location on the map and reorients the laser rangefinder on the known point with the corrected azimuth. Self-location can be done by using two known points, one known point and one burst, or two bursts.

---

*Note.* The observer's location can also be determined by using only one point. However, the accuracy of the observer's location depends on the accuracy of the initial azimuth orientation of the laser rangefinder.

---

A-2. With this method, the observer uses two known points (see figure A-1 on page A-2). A known point may be established through survey, firing, or measuring from a map. If measured from a map, the point must be easily identifiable on the ground; for example, a church steeple, a water tower, or a prominent road junction. The observer must be sure of the ability to associate the known point on the ground with the same point on the map. This method of self-location is the most accurate and, therefore, the preferred technique. When using a voice call for fire, the observer will announce TRILATERATION in the method of fire. The observer sends to the FDC the direction, distance, and vertical angle to two known points separated by at least 300 mils, and must also specify which known point is on the left. The FDC determines the laser rangefinder location. Then the FDC determines the correct orienting azimuth to one of the known points. This information is sent through secure means to the observer. The observer then plots own location on the map and reorients the laser rangefinder on the known point with the corrected azimuth. Self-location can be done by using two known points, one known point and one burst, or two bursts.

**Example**

A24 (FDC) THIS IS A58 (OBS), TRILATERATION, OVER.  
 KNOWN POINT CADDO, DIRECTION 1743,  
 DISTANCE 1230,  
 VERTICAL ANGLE PLUS 10,  
 KNOWN POINT FLATTOP,  
 DIRECTION 2338,  
 DISTANCE 3180,  
 VERTICAL ANGLE MINUS 10, OVER.  
 KNOWN POINT CADDO ON LEFT, OVER.

A58 (OBS) THIS IS A24 (FDC), LOCATION NK47253824,  
 DIRECTION TO CADDO 1723, OVER.

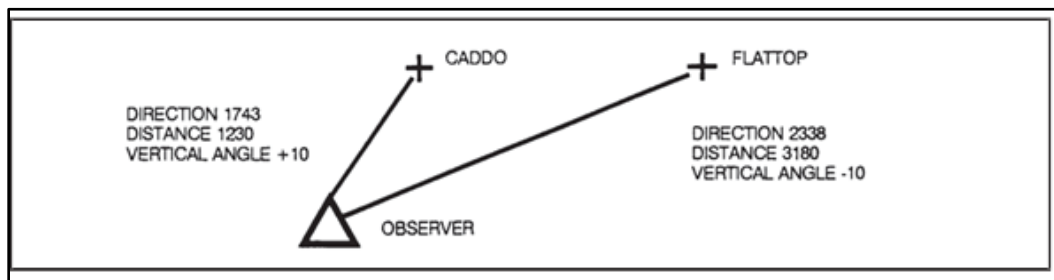

Figure A-1. Self-location by use of two known points

## SELF-LOCATION BY USE OF ONE KNOWN POINT AND ONE BURST

A-3. If only one known point is available, the second point may be established by a planned burst of an HE or a WP round (see figure A-2 on page A-3). The observer should plan the location of the burst so that it is separated from the known point by at least 300 mils. Graze bursts should be used. Using the laser rangefinder, the observer ranges the known point and the burst of the round to determine the direction, distance, and vertical angle for each of the two points, and reports these to the FDC. The FDC computes the laser rangefinder location and corrected azimuth to the known point and sends the information to the observer.

---

*Note.* The accuracy of the computed laser rangefinder location and the reference azimuth is affected by the accuracy of the firing data used to fire the round. The FDC should use the most accurate data available.

---

**Example**

A24 (FDC) THIS IS A58 (OBS), SELF LOCATION, 1 ROUND, OVER.  
 KNOWN POINT CADDO, DIRECTION 1743,  
 DISTANCE 3180,  
 VERTICAL ANGLE PLUS 10, OVER.  
 1 ROUND, GRID NK598376, OVER.  
 (Round is fired and observed.)  
 DIRECTION 2105,  
 DISTANCE 3420,  
 VERTICAL ANGLE MINUS 12, OVER.  
 KNOWN POINT CADDO ON LEFT, OVER.

A58 (OBS) THIS IS A24 (FDC), LOCATION NK47253824,  
 DIRECTION TO CADDO 1723, OVER.

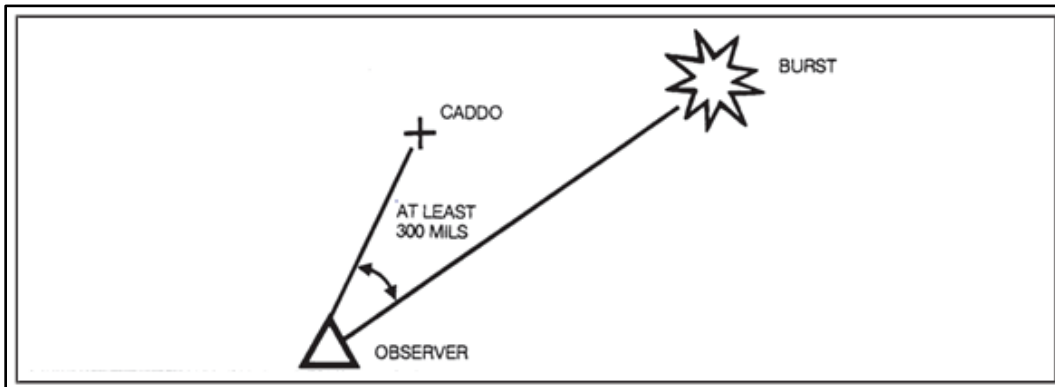

Figure A-2. Self-location by use of one known point and one burst

## SELF-LOCATION BY USE OF TWO BURSTS.

A-4. If no known points are available, the bursts of two rounds may be used as the prearranged points. The observer selects the locations at which he wants the rounds to burst, ensuring that they are separated by at least 300 mils (see figure A-3 on page A-4). Also, the direction to a reference point is determined. When the rounds are fired, the observer ranges the bursts to determine the direction, distance, and vertical angle of each burst point. The observer reports these to the FDC and records the direction to the second burst point. The FDC computes the laser rangefinder location and corrected azimuth to the second burst point and sends the information to the observer. The observer determines the difference between the measured azimuth to the second burst point and the azimuth that the FDC reported to the second burst point. The angular difference, in mils, is plus if the reported azimuth from the FDC is greater than the azimuth the observer measured. It is minus if the reported azimuth from the FDC is less than the azimuth measured by the observer. The difference is applied to the initial reference point azimuth by either adding or subtracting, as the sign indicates. The observer places the resulting azimuth on the laser rangefinder while sighting on his initial reference point.

**Example**

The observer occupies a position and initially orients the laser rangefinder by using an M2 compass, then selects a reference point (HOUSE) and measures the azimuth to **HOUSE** as 5,796 mils. No known points are available, so the observer requests self-location using two bursting rounds.

**A24 (FDC) THIS IS A58 (OBS), SELF LOCATION, 2 ROUNDS, OVER.  
 1 ROUND, GRID NK603368, OVER. (Round is fired and observed.)  
 DIRECTION 6398, DISTANCE 4110, VERTICAL ANGLE MINUS 9, 1 ROUND, GRID NK564381, OVER. (Round is fired and observed.)  
 DIRECTION 5927, DISTANCE 3840, VERTICAL ANGLE MINUS 11, FIRST ROUND ON LEFT, OVER.**

The FDC determines and sends to the observer the laser rangefinder location and orienting azimuth to the second burst point.

**A58 (OBS) THIS IS A24 (FDC), LOCATION NK58723423, DIRECTION TO SECOND ROUND 5918, OVER.**

Having recorded the laser measured azimuth to the second burst point, the observer records the FDC reported information and makes the following computations:

Laser rangefinder measured azimuth	5927
FDC reported azimuth	<u>5918</u>
Angular difference	-9
Observer azimuth to reference point (M2 compass)	5769
Angular difference	<u>-9</u>
Corrected azimuth to reference point ( <b>HOUSE</b> )	5760

The observer places this resulting azimuth on the laser rangefinder while sighting on reference point **HOUSE**.

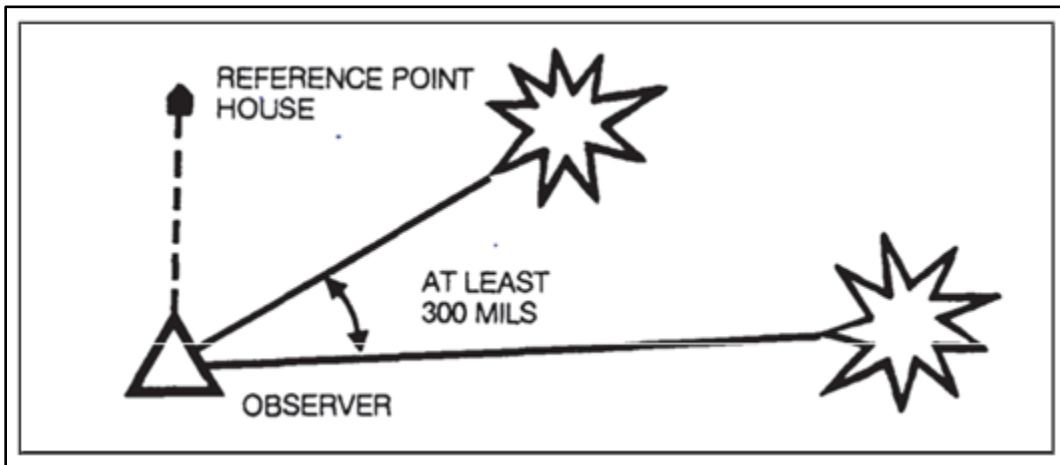

**Figure A-3. Self-location by use of two bursts**

**SELF-LOCATION BY USE OF IMAGERY**

A-5. This is the most preferred method of self-location. It is especially useful in static Ops or when at a halt while on patrol. Utilizing a pocket-size forward entry such as the PFED with PFI viewer or FOS system loaded



with PSS SOF and DPPDB imagery, a trained observer team can generate a mensurated grid to their location. Other imagery systems that may be available can be used, but will not generate as accurate a location.

## SELF-LOCATION BY USE OF DIGITAL SYSTEMS

A-6. This method is also highly accurate. It is best employed while on patrol either on foot or in a vehicle. GPS systems such as the Defense Advanced GPS Receiver provide a grid by triangulating the location of the receiver in reference to satellites. Other systems such as the LLDR IHH or PFED use an on board GPS to self-locate and can be used to generate an accurate self-location.

### Example

A laser rangefinder equipped observer, A23, has no known points in the area. The FDC, A16, instructs observer to contact A47, a nearby observer with a lightweight laser designator rangefinder that is accurately located and oriented, for assistance in establishing known points in the target area. Mutually agreeable points have been identified.

**A16 THIS IS A47, KNOWN POINTS FOR A23, OVER.  
KNOWN POINT TREE, DIRECTION 0832, DISTANCE 5740, VERTICAL ANGLE MINUS 9, KNOWN POINT TANK BODY, DIRECTION 0947, DISTANCE 6370, VERTICAL ANGLE MINUS 11, OVER.**

With two known points established, the observer operating the laser rangefinder being located can now self-locate by using two known points.

**A16 THIS IS A23, SELF LOCATION, OVER.  
KNOWN POINT TREE, DIRECTION 5823, DISTANCE 6240, VERTICAL ANGLE MINUS 10, KNOWN POINT TANK BODY, DIRECTION 6207, DISTANCE 5970, VERTICAL ANGLE MINUS 14, KNOWN POINT TREE ON LEFT, OVER.**

**A23 THIS IS A16. LOCATION NK38374512, DIRECTION TO TREE 5815, OVER.**

## LOCATION BY SIMULTANEOUS OBSERVATION

A-7. An observer with an accurately located and oriented laser rangefinder can help determine the location of another laser rangefinder. This is done by performing a simultaneous observation on two illuminating (illum) rounds with the other laser rangefinder observer (see figure A-4 on page A-6). This technique is especially useful during periods of limited visibility. Both observers must be able to see and lase the illuminating rounds. Also, these illuminating rounds must be separated by at least 300 mils as observed from the laser rangefinder position being located. Thorough prior coordination between the two observers must take place for this technique to be effective. The observer with the laser rangefinder being located records the direction to a reference point and prepares to observe. The observer with the accurately located laser rangefinder acts as the controlling station and initiates the illumination call for fire as outlined in the example.

*Note.* Ranging an illuminating canister may be difficult for some observers. A variation of this techniques is to adjust the illumination so that it burns on the ground. Both observers then range the flare.

### WARNING

**Lasing or ranging above the skyline requires specific authorization from range control during peacetime training.**

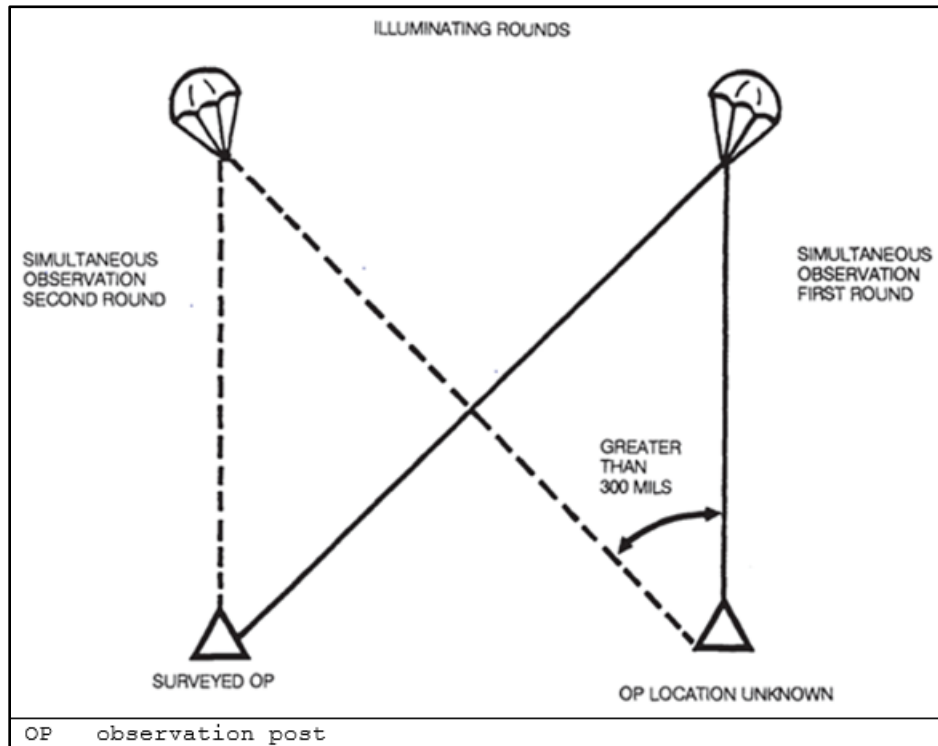

Figure A-4. Location second observation post by simultaneous observation

### Example

A47 is the observer with the accurately located laser rangefinder. A23 is the observer with the laser rangefinder being located. A16 is the battery FDC. Coordination between A47 and A23 has already taken place.

**A16 THIS IS A47, SIMULTANEOUS OBSERVATION WITH A23, OVER.  
1 ROUND, GRID NK374522, 1 ROUND, GRID NK391516, OVER.  
ILLUMINATION, BY ROUND AT MY COMMAND, OVER.**

**A47 THIS IS A23, READY TO OBSERVE, OVER.**

**A47 THIS IS A16, READY, OVER.**

(A47 commands the first round to be fired.)

As the illuminating round descends, the observer with the accurately located laser rangefinder coordinates simultaneous lasing on the flare. The observer begins tracking the descending flare and has the **RTO** transmit **TRACKING, TRACKING, TRACKING, LASE.**

Once the command **LASE** is given, both observers lase or range the flare simultaneously.

**A16 THIS IS A47, DIRECTION 0437, DISTANCE 3780, VERTICAL ANGLE PLUS 21.**

**A16 THIS IS A23, DIRECTION 6377, DISTANCE 4120, VERTICAL ANGLE PLUS 23.**

The observers must use their judgment to determine if they have received an accurate return from the flare. If one of the observers believes to have an inaccurate return, the tracking phase should be repeated before any data is sent to the FDC. Once the observation data have been completed for both rounds, the FDC determines the location and orienting azimuth correction.

**A23 THIS IS A16, LOCATION NK49163842, DIRECTION TO SECOND ROUND 0317, OVER.**

The observer with the laser rangefinder being located records own location on the map and adjusts the azimuth to the reference point as described in the procedures for self-location using two bursts.

## OBSERVER ACTIONS AFTER BEING LOCATED

A-8. As soon as the observer determines own accurate location, the observer should determine polar plot data to several prominent points around the position. The FDC can determine the grid of these points for the observer making them known points. Then the observer can refer to these known points during movement, and can also use them in self-location by using the two known point's technique to locate observer's new position.

A-9. When the laser rangefinder location has been accurately determined and is known by the FDC, the observer uses the laser rangefinder to measure distance, direction, and vertical angle to targets from own location.

A-11. Polar plot data taken from the laser rangefinder can be sent directly to the FDC (preferred), or it can be converted to a grid location and then sent to the FDC.

This page intentionally left blank.

## Appendix B

# Crater and Shell Fragment Analysis and Reports

This appendix tells you how to properly conduct a crater and shell fragment analysis and reporting.

### **WARNING**

**PRIOR TO INVESTIGATING A CRATER, EXPLOSIVE ORDNANCE DISPOSAL PERSONNEL HAVE TO ADVISE PERSONNEL THAT THE AREA IS CLEAR AOF EXPLOSIVE HAZARDS. FAILURE TO DO SO MAY RESULT IN INJURY OR DEATH**

---

*Note.* Under any circumstances, if UXOs or residual explosive hazards are suspected, do not attempt to conduct crater analysis. Notify EOD personnel immediately.

---

## CRATER ANALYSIS TEAM

B-1. In crater analysis, difference in angle of fall, projectile burst patterns, directions of flight, and fuze settings will help distinguish between enemy batteries firing on a given area.

B-2. To adequately support their maneuver unit, fire support personnel must know how to analyze and report crater analysis. Each unit (including units normally located in rear areas) should select and train at least one team of two or three members.

## EQUIPMENT

B-3. Three elements (direction, dimensions, and curvature) must be measured for crater analysis. The equipment used by crater analysis teams should consist of the following items:

- Declination aiming circle (or M2 compass), stakes, and communication wire or strong cord used to obtain the direction from the crater to the weapon that fired the projectile.
- A curvature template (see figure B-1 on page B-2) to measure the curvature of the fragment to determine the caliber of the shell. The template can be constructed of heavy cardboard, acetate, wood, or other appropriate material. It may be necessary to construct several templates with different caliber curves to cover all enemy calibers used.

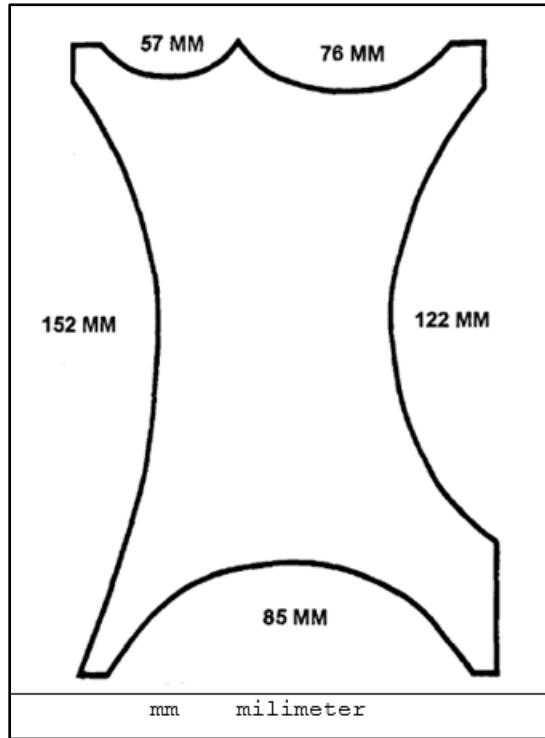

Figure B-1. Curvature template

## VALUE OF ANALYSIS

- B-4. By analyzing shell craters, it is possible to do the following:
- Verify as confirmed locations, suspected locations that have been obtained by others means.
  - Confirm the presence of enemy artillery and obtain an approximate direction to it.
  - Approximate the calibers and types of suspected enemy weapons.

## CRATER ANALYSIS

B-5. The first step in crater analysis is to locate a usable crater for determining the direction to the hostile weapon. The crater should be clearly defined on the ground and should be reasonably fresh.

B-6. Since the crater is the beginning point for plotting the direction to the enemy weapon, the grid coordinates of the crater should be determined as an eight-digit grid, or as accurately as time and method used will allow.

B-7. The direction to the firing weapon must be determined by one of the methods described in the following paragraphs.

### LOW-ANGLE MTSO CRATER (ARTILLERY)

B-8. There are two methods of obtaining a direction to a hostile weapon from this type of crater. The best results are obtained by determining a mean, or average, of several directions obtained by using both methods.

- The detonation and forward momentum of a fired munition creates a visible pattern at the site of impact similar to an arrow which points to the rear (towards the weapon from which the round was fired).
- The fuze continues along the line of flight, creating a fuze furrow.

### Fuze Furrow and Center-of-Crater Method

B-9. In this method, stakes are placed in the center of crater and in the fuze furrow. Then the direction is measured to the hostile weapon. (See figure B-2) A variation of this method is to place a stake where the shell

entered the ground instead of the fuze furrow and determine the direction in the same manner. This method is rarely possible, however, since indications of the point of entry are usually destroyed by the explosion of the shell. The five steps of this method are as follows:

- Place a stake in the center of the crater.
- Place a second stake in the fuze furrow at the point where the fuze was blown forward to the front of crater.
- Setup direction-measuring instrument in line with the stakes and away from fragments.
- Orient the instruments.
- Measure the direction to the hostile weapons.

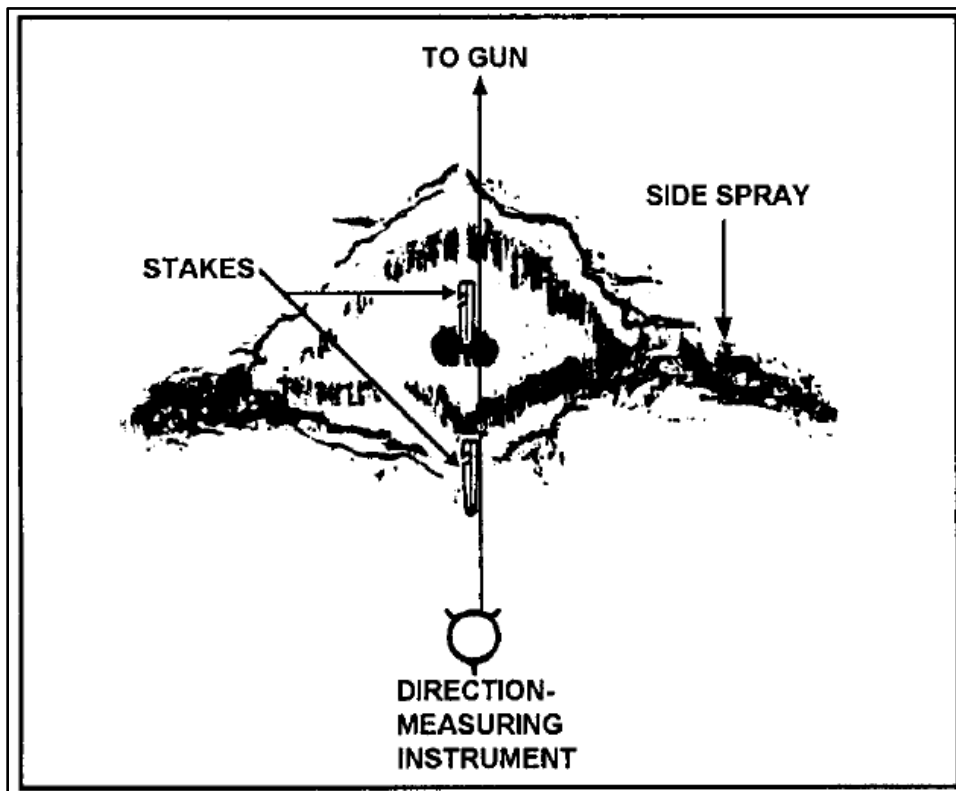

Figure B-2. Fuze furrow and center-of-crater method

### Side-spray Method

B-10. Another method to measure the direction to a hostile weapon is to bisect the angle formed by the lines of side-spray (see figure B-3 on page B-4). The seven steps in the side spray method are as follows:

- Place a stake in the center of the crater.
- Place two stakes, one at the end of each line of side spray, equidistant from the center stake.
- Hold a length of communications wire (or another appropriate field-expedient means) to each side-spray stake, and strike an arc forward of the fuze furrow.
- Place a stake where these arcs intersect.
- Set up a direction-measuring instrument in line with the center stake and the stake at the intersection of the arcs.
- Orient the instrument.
- Measure the direction to the firing weapon.

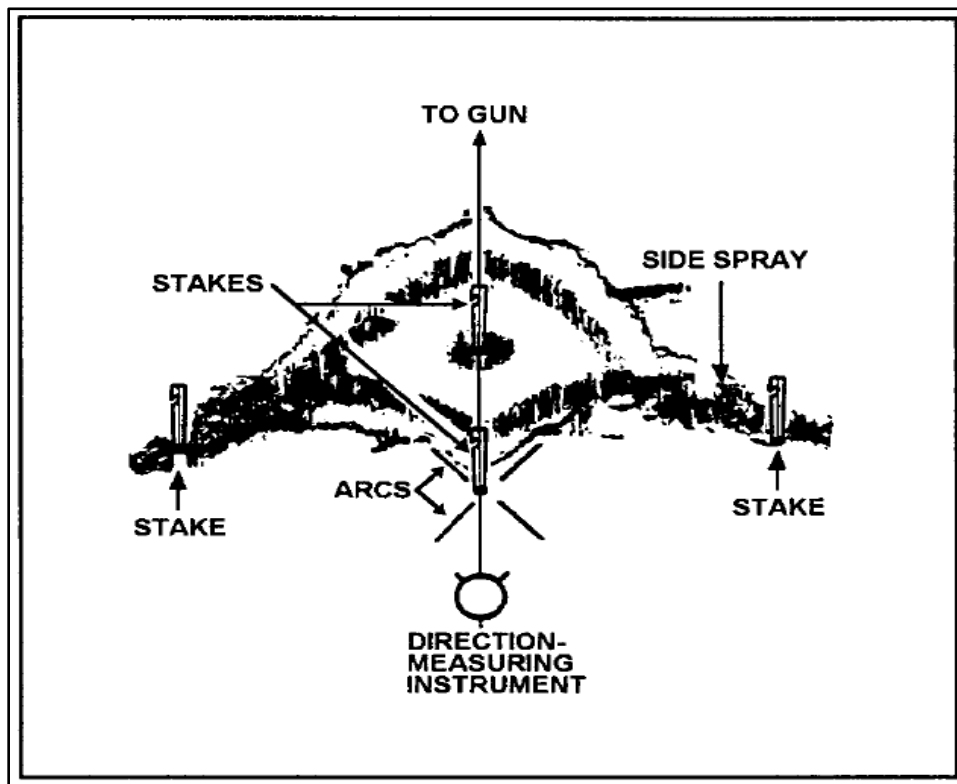

Figure B-3. Side-spay method

### LOW-ANGLE FUZE DELAY CRATERS (ARTILLERY)

B-11. There are two types of fuze delay craters: ricochet and mine action.

#### Ricochet

B-12. The projectile enters the ground in line following the trajectory and continues in a straight line for a few feet, causing a ricochet furrow. The projectile normally deflects upward and, at the same time, it changes direction usually to the right as the result of the spin, or rotation, of the projectile. The effect of the airburst can be noted on the ground. Directions obtained from ricochet craters are considered to be the most reliable. The five steps to determine direction from a ricochet furrow (see figure B-4 on page B-5) are as follows:

- Clean out the furrow.
- Place stakes at each end of a usable straight section of the furrow.
- Set up a direction-measuring instrument in line with the stakes and away from fragments.
- Orient the instrument.
- Measure the direction to the weapon.



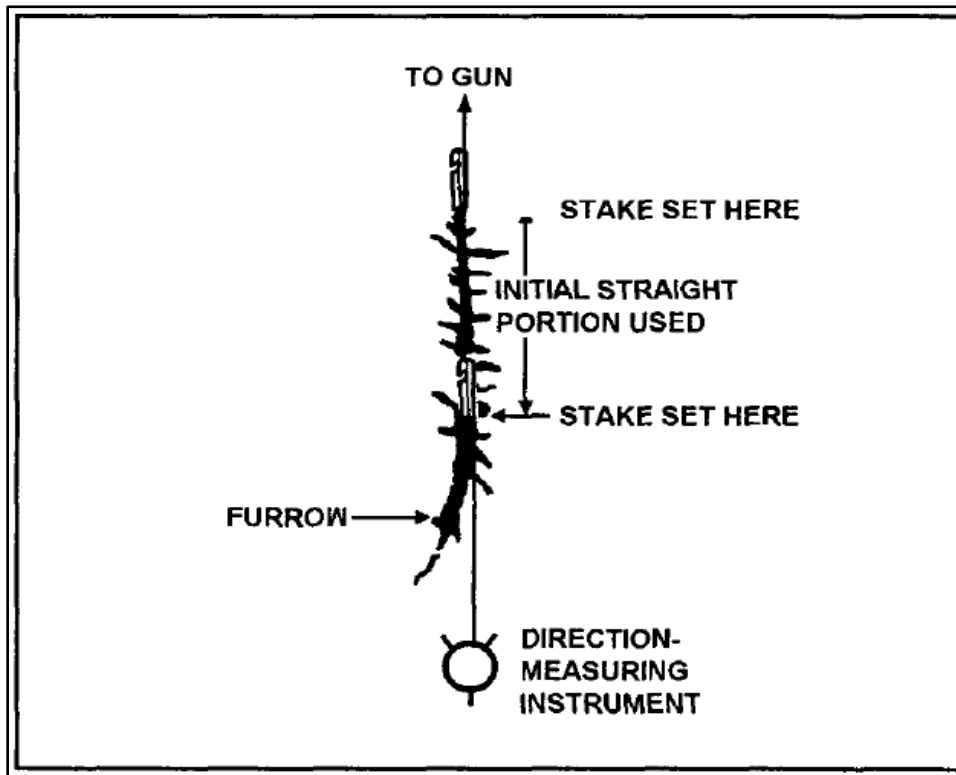

Figure B-4. Ricochet furrow method

### Mine Action

B-13. This occurs when a shell burst beneath the ground. Occasionally, such a burst will leave a furrow which can be analyzed in the same manner as the ricochet furrow. A mine action crater which does not have furrow cannot be used to determine the direction to the weapon.

### HIGH-ANGLE SHELL CRATERS (MORTARS)

B-14. In a typical mortar crater, the turf at the forward edge (the direction away from the hostile mortar) is undercut. The rear edge of the crater is shorn of vegetation and grooved by splinters.

B-15. When fresh, the crater is covered with loose earth, which can cover the firm, burnt inner crater. The ground surrounding the crater is streaked by splinter grooves that radiate from the point of detonation. The ends of the splinter grooves on the rearward side are on an approximately straight line. This line is perpendicular to the line of flight if the crater is on level ground or on a slope with contours perpendicular to the plane of fire.

B-16. A fuze tunnel is caused by the fuze burying itself at the bottom of the inner crater in front of the point of detonation.

B-17. Three methods may be used to determine direction from a mortar shell crater—the main axis, splinter groove, and fuze tunnel methods.

### Main Axis Method

B-18. The four steps to determine direction by the main axis method (see figure B-5 on page B-6) areas follow:

- Lay a stake along the main axis of the crater, dividing the crater into symmetrical halves. The stake points in the direction of the mortar.
- Set up a direction-measuring instrument in line with the stake and away from fragments.
- Measure the direction to the weapon.

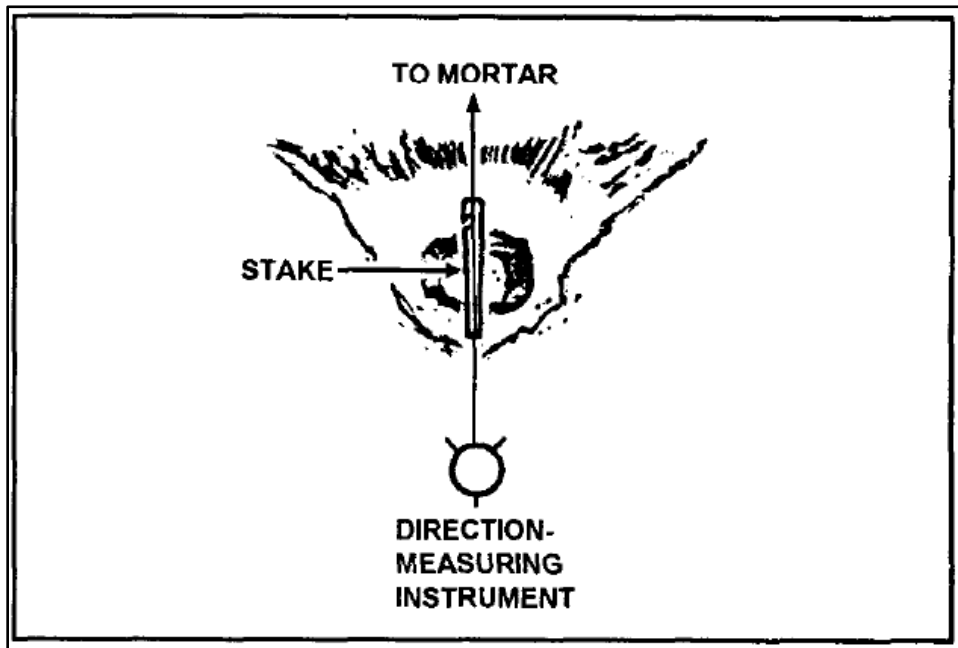

Figure B-5. Main axis method

### Spinter Grove Method

B-19. The five steps to determine direction by the splinter groove method (see figure B-6) are as follows:

- Lay a stake along the ends of the splinter grooves that extend from the crater.
- Lay a second stake perpendicular to the first stake through the axis of the fuze tunnel.
- Set up a direction-measuring instrument in line with the second stake and away from fragments.
- Orient the instrument.
- Measure the direction to the weapon.

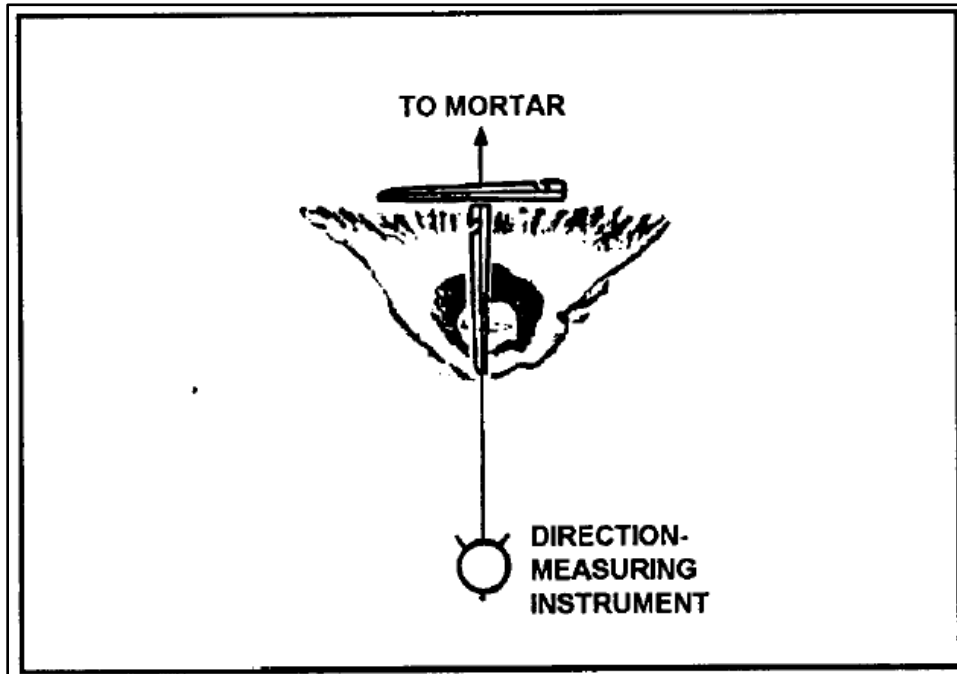

Figure B-6. Splinter groove method

### Fuze Tunnel Method

B-20. The four steps to determine direction by the fuze tunnel method (see figure B-7) are as follows:

- Place a stake in the fuze tunnel.
- Set up a direction-measuring instrument in line with the stake and away from fragments.
- Orient the instrument.
- Measure the direction to the weapon.

---

*Note.* If the angle of fall is too great (a 90° angle), the fuze tunnel method cannot be used.

---

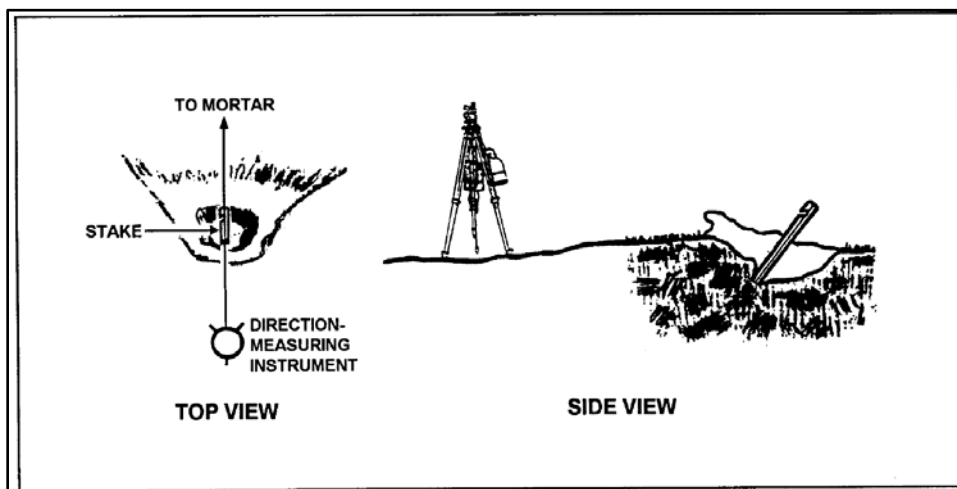

Figure B-7. Fuze tunnel method

## ROCKET CRATERS

B-21. A crater resulting from a rocket impacting with a low or medium angle of fall is analyzed in the same manner as an artillery crater resulting from a projectile armed with fuze quick. However, if the rocket impacts with a high angle of fall, the crater is analyzed in the same manner as a crater resulting from a mortar round. The tail fins, rocket motor, body, and other parts of the rocket, may be used to determine the caliber and type of rocket fired.

## SHELL FRAGMENT ANALYSIS

B-22. Dimensions of the parts as well as complete shells vary according to the caliber and type of shell. Shell fragments a must be collected to approximate the type, caliber, and country that manufactured the weapon and projectile. A typical shell is shown in figure B-8.

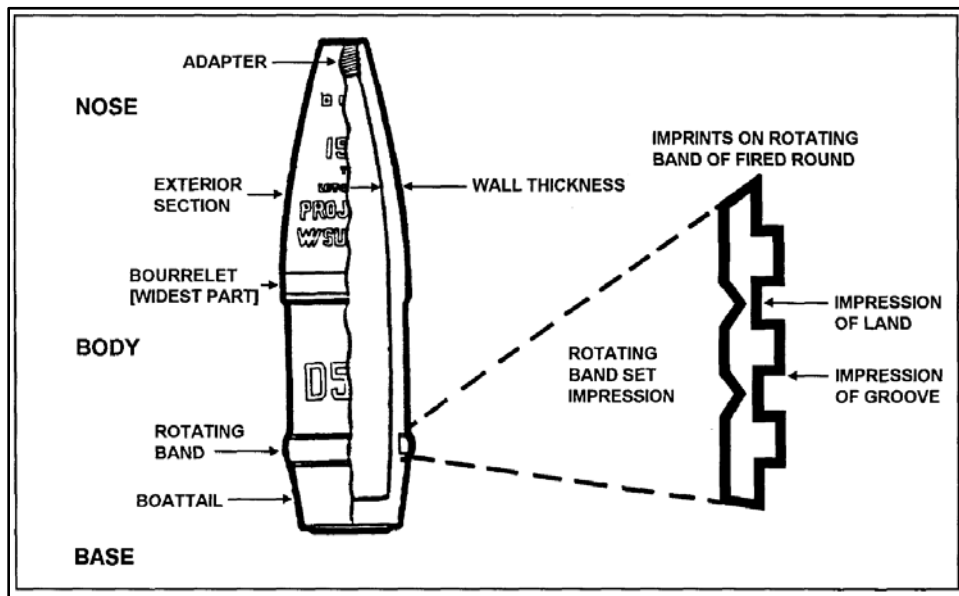

Figure B-8. Projectile

## DUDS AND LOW-ORDER BURSTS

B-23. The most logical means of identifying the caliber of a projectile is to inspect a dud of that caliber. However, since a dud may not always be pattern or rifling imprints. Width, number, and size of rotating bands. Dimensions and pattern of keying or knurling on the band seat. Dimensions and pattern of keying and knurling impressed on the rotating band. Available (or, if available, may be too dangerous to handle), a low-order burst is the next best means of identification. When the explosive filler is incompletely detonated, a low-order burst occurs and large shell fragments result. Such Note: Spin-stabilized artillery projectiles require a rotating band and band seat. Large pieces can be used to identify thread count, curvature, d. Tail Fins. A mortar may be identified from the tail wall thickness, and other information not obtainable on tin. Often, tail fins are found in the smaller fragments. (see figures B-1 and B-8.)

## HIGH-ORDER BURST

B-24. A high-order burst normally results in small, deformed fragments. These fragments are useless for identification purposes unless they include a section of either the rotating band or the rotating band seat. Fragments of either of these sections positively identify the shell, since each shell has its own distinctive rotating band markings.

## ROTATING BAND AND BAND SEATS

B-25. A shell may be identified as to caliber, type and nation of origin from the following (see figure B-9):

- Pattern or rifling imprints.
- Width, number, and size of rotating bands.
- Dimensions and pattern of keying or knurling on the band seat.
- Dimensions and pattern of keying and knurling impressed on the rotating band.

*Note.* Spin-stabilized artillery projectiles require a rotating band and band seat.

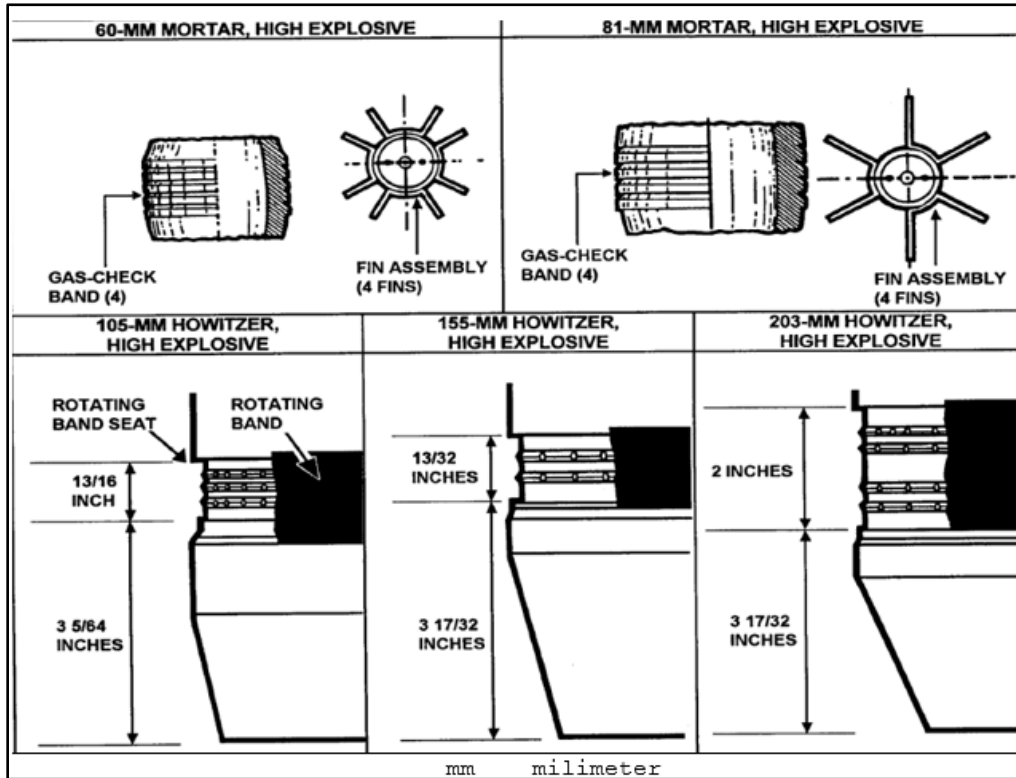

Figure B-9. Shell fragment and tail identification, US ammunition

### TAIL FINS

B-26. A mortar may be identified from the tail fins (see figures B-9 on this page, and figures B-10 on page B-10, and B-11 on page B-11). Often, tail fins are found in the fuze tunnel of the crater. A mortar that is not fin-stabilized may be identified from the pieces of the projectile on which the rifling is imprinted.

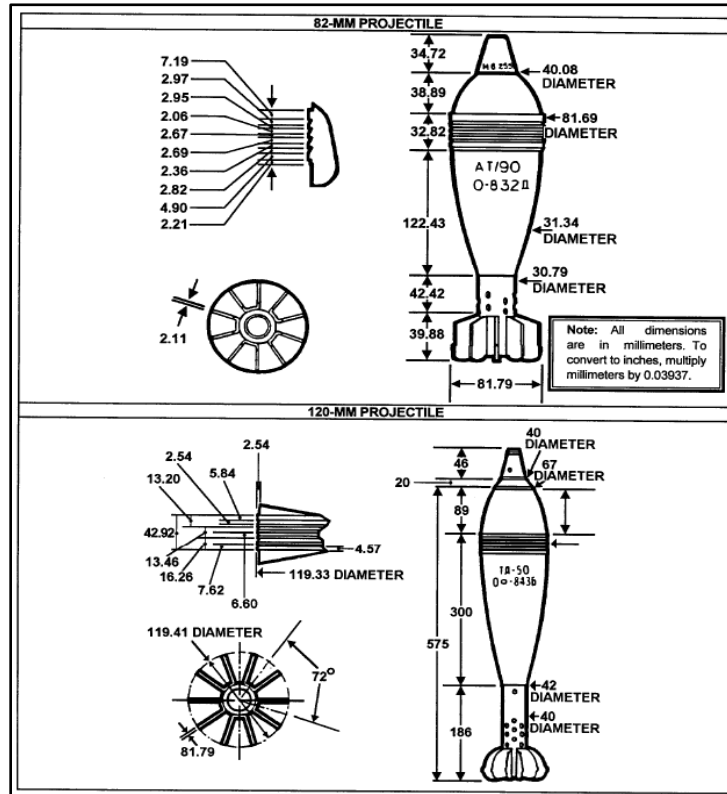

Figure B-10. Other nation's ammunition

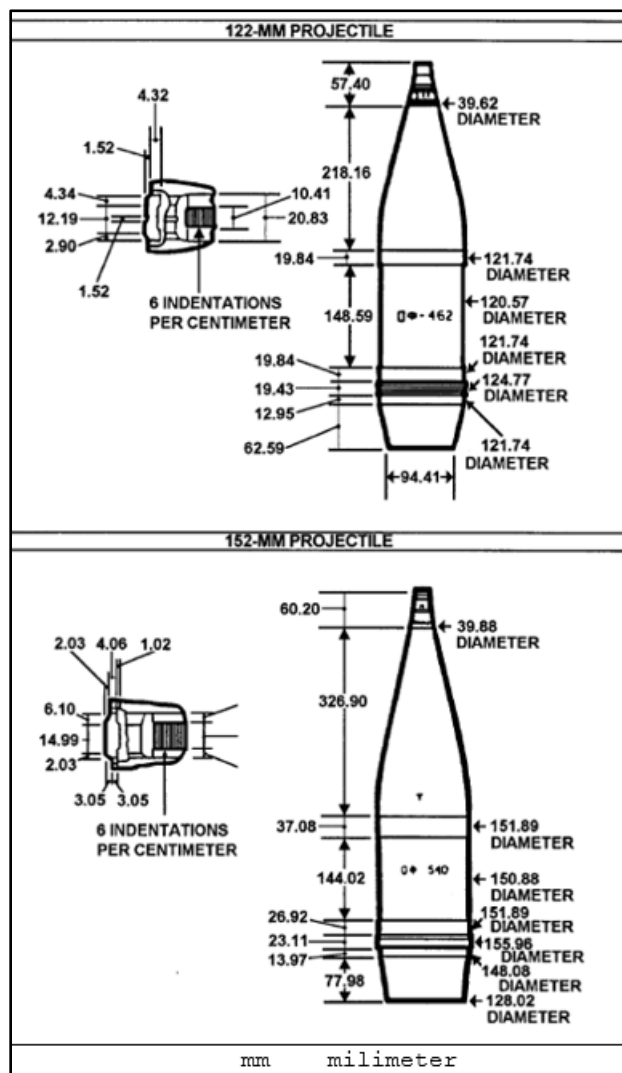

Figure B-11. Other nation's ammunition (continued)

## FUZE

B-27. Since the same type of fuze may be used with several different calibers or types of projectile, it is impossible to establish the type and caliber of a weapon by the means.

*Note.* With the exception of the rotating bands and band seats or the tail fins, different types of shells may be identical in one dimension (such as wall thickness) but seldom will be alike in two or more dimensions. Therefore, it is necessary to obtain two or more measurements to make a positive identification.

## SHELLING REPORTS

B-28. The division artillery (DIVARTY) is responsible for counterfire. Therefore, reports of shelling or mortaring should be forwarded as quickly as possible to the DIVARTY main command post through either fire direction or fire support channels via electronic means or manually using DA Form 2185, Artillery Counterfire Information. If a report is received by a brigade combat team (BCT), field artillery battalion and that battalion decides to employ counterfire on the enemy position, the report of action taken and a damage assessment, if available, should be forwarded to the DIVARTY main command post when the action is completed.

B-29. **Instructions** of how to fill out DA Form 2185 (figure B-12 on page B-12); the four blanks above SECTION I of DA Form 2185 are not completed by the SHELREP team. They are filled in by the receiving agency. Items B and K or SECTION I are encoded for security reasons. The current call sign or code name for the unit is used in item A. Item B is not applicable when this form is used for crater analysis. SECTIONS II and III are completed by the target processing section of the DIVARTY CP. The information contained in a SHELREP is forwarded by an artillery battalion S-2 to the DIVARTY fires cell.

B-30. The location of the crater is plotted on an overlay and a line is drawn representing the direction measured to the weapon. The information is compared with that received from other sources and attempts to locate enemy weapons from the intersections of direction lines to weapons of the same caliber.

ARTILLERY COUNTERFIRE INFORMATION										
For use of this form, see ATP 3-09.30; the proponent agency is TRADOC.										
RECEIVED BY: PFC WHITE		FROM: SFC WHITE			TIME: 0010Z			NUMBER: 01		
SECTION I - BOMBREP, SHELLREP, OR ROCKREP (Cross out items not applicable)										
UNIT OF ORIGIN (Current call sign, address group or code name)	POSITION OF OBSERVER (Encode if HQ or important OP or if SHELL [state which] in mils unless otherwise stated). (Omit for aircraft)	DIRECTION (Grid bearing of FLASH, SOUND or GROOVE of SHELL [state which] in mils unless otherwise stated). (Omit for aircraft)	TIME FROM	TIME TO	AREA BOMBED, SHELLED OR MORTARED (Grid ref [in clear] or grid bearing to impact in mils and distance from observer in meters [encoded]) Dimensions of the area in meters by (the radius) or (length and width)	NUMBER AND NATURE OF GUNS (Mortars, rocket launchers, aircraft or other methods of delivery)	NATURE OF FIRE (Adjustment, fire for effect, or harassing) (May be omitted for aircraft)	NUMBER, TYPE AND CALIBER (State whether measured or assumed) OF SHELLS, ROCKETS (or MISSILES), AND BOMBS	TIME OF FLASH-TO BANG (Omit for aircraft)	DAMAGE (Encode if required)
FOXTROT 6	4QFJ12345678	NORTH	1200000 JULY17	1200001 JULY17	4QFJ12345678	MORTARS 5	HARRASSING	ASSUMED	2 SECONDS	NONE
A	B	C	D	E	F	G	H	I	J	K
SECTION II - LOCATION REPORT						SECTION III - COUNTERFIRE ACTION				
REMARKS	SERIAL NUMBER (Each location that is produced by a locating unit is given a serial number)	TARGET NUMBER (If the weapon or activity has previously been given a target number, it will be entered here)	POSITION OF TARGET (The grid reference or grid bearing and distance of the located weapon or activity)	ACCURACY (The accuracy to which the weapon was located, CEP in meter and the means of location if possible)	TIME OF LOCATION (Actual time the location was made)	TARGET DESCRIPTION (Dimensions if possible): 1. Radius of target 2. Target length and width in meters	TIME FIRED (Against hostile target)	FIRED BY	NUMBER OF ROUNDS, TYPE OF FUZE, AND PROJECTILES	
	12345678	TGT'S	4QFJ 98745612	5 METERS	120000JULY17	OP4	120005JULY17	DELTA	12 ROUNDS 155MM	
L	M	N	O	P	Q	R	S	T	U	
DA FORM 2185, SEP 2017 <span style="float:right">PREVIOUS EDITIONS ARE OBSOLETE. <small>APD LC V1.01.02</small></span>										
BOMBREP		bomb report				SHELLREP		shell report		
ROCKREP		rocket report				OP		observation report		

Figure B-12 DA Form 2185 (Artillery Counterfire Information)

**FRAGMENTS**

B-31. Any usable fragments obtained from crater analysis should be tagged and sent to the battalion intelligence officer. As a minimum, the tag should indicate the following:

- The location of the hostile weapon, if known.
- The direction to the hostile weapon.
- The date-time group of the shelling.
- Mortar, cannon artillery, rocket, or missile, if known.



# Glossary

The glossary lists acronyms and terms with Army or joint definitions. Where Army and joint definitions differ, (Army) precedes the definition. Terms for which ATP 3-09.30 is the proponent are marked with an asterisk (\*). The proponent publication for other terms is listed in parentheses after the definition.

## SECTION I – ACRONYMS AND ABBREVIATIONS

<b>ACM</b>	Airspace Coordination Measure
<b>ADAM</b>	area denial artillery munitions
<b>ADRP</b>	Army doctrine reference publication
<b>AMC</b>	At My Command
<b>APICM</b>	Antipersonnel improved conventional munitions
<b>APMI</b>	Accelerated Precision Mortar Initiative
<b>ATACMS</b>	Army Tactical Missile System
<b>ATP</b>	Army techniques publication
<b>BCT</b>	brigade combat team
<b>BIP</b>	ballistic impact point
<b>BP</b>	Battle Position
<b>CAS</b>	close air support
<b>CEP</b>	circular error probable
<b>CFE</b>	Call For Fire
<b>DA</b>	Department of the Army
<b>DPICM</b>	dual purpose improved conventional munitions
<b>DPPDB</b>	Digital Point Precision Data Base
<b>DS</b>	Direct Support
<b>FAC(A)</b>	forward air controller (airborne)
<b>FDC</b>	fire direction center
<b>FIST</b>	fire support team
<b>FO</b>	forward observer
<b>FOS</b>	Forward Observer System
<b>FPF</b>	Final Protective Fire
<b>FS</b>	Fire Support
<b>FSCM</b>	Fire Support Coordination Measure
<b>FSNCO</b>	Fire Support Non-commissioned Officer
<b>FSO</b>	fire Support Officer
<b>GMLRS</b>	Guided multiple launch rocket system
<b>GPS</b>	Global Positioning System
<b>HAE</b>	Height Above Ellipsoid
<b>HC</b>	hexachlorethane
<b>HE</b>	high explosive
<b>HIMARS</b>	High Mobility Artillery Rocket System
<b>HOB</b>	height of burst
<b>ICM</b>	improved conventional munitions
<b>IP</b>	Ingress Point
<b>IR</b>	infrared
<b>JFO</b>	joint fires observer
<b>JP</b>	joint publication

<b>JTAC</b>	joint terminal attack controller
<b>LLDR</b>	Lightweight Laser Designator Rangfinder
<b>LOW</b>	Law Of War
<b>METT-TC</b>	mission, enemy, terrain and weather, troops and support available, time available, and civil considerations
<b>MLRS</b>	Multiple Launch Rocket System
<b>MPI</b>	mean point of impact
<b>MTL</b>	maneuver-target line
<b>MTO</b>	message to observer
<b>MTSQ</b>	mechanical time super quick
<b>NSFS</b>	Naval Surface Fire Support
<b>NATO</b>	North Atlantic Treaty Organization
<b>NGA</b>	National Geospatial Agency
<b>OP</b>	Observation Post
<b>OF</b>	Observed fire
<b>PD</b>	Point Detonating
<b>PE<sub>R</sub></b>	probable error in range
<b>PFED</b>	pocket-size forward entry device
<b>PFI</b>	precision fire imagery
<b>PGK</b>	Precision Guidance Kit
<b>PSS-SOF</b>	Precision Strike Suite-Special Operations Forces
<b>RAAMS</b>	Remote antiarmor mine system
<b>ROE</b>	Rules of Engagement
<b>RP</b>	red phosphorus
<b>SEAD</b>	Suppression of Enemy Air Defense
<b>SOP</b>	standard operating procedure
<b>STANAG</b>	Standardized Nato Agreement
<b>TA</b>	Target Acquisition
<b>TAC</b>	Terminal Attack Control
<b>TCM</b>	Target Coordinate Mensuration
<b>TLE</b>	target location error
<b>TMO</b>	Target Mensuration Only
<b>TOT</b>	Time On Target
<b>UA</b>	Unmanned Aircraft
<b>USMC</b>	United States Marine Corps
<b>VT</b>	variable time
<b>WP</b>	white phosphorous
<b>ZF</b>	Zone of Fire

## SECTION II – TERMS

### **call for fire**

(Army) A request for fire containing data necessary for obtaining the required fire on a target. (FM 3-09)

### **combat identification**

(DOD) The process of attaining an accurate characterization of detected objects in the operational environment sufficient to support an engagement decision. Also called CID. (JP 3-09)

**final protective fire**

(DOD) An immediately available prearranged barrier of fire designed to impede enemy movement across defensive lines or areas. Also called FPF. (JP 3-09.3)

**fire support**

(DOD) Fires that directly support land, maritime, amphibious, and special operations forces to engage enemy forces, combat formations, and facilities in pursuit of tactical and operational objectives. See also Fires. (JP 3-09)

**fire support team**

(DOD) A field artillery team provided for each maneuver company/troop and selected units to plan and coordinate all supporting fires available to the unit, including mortars, field artillery, naval surface fire support, and close air support integration. Also called FIST. See also close air support; field artillery; fire support; support. (JP 3-09.3)

**forward observer**

(DOD) An observer operating with front line troops trained to adjust ground or naval gunfire and pass back battlefield information. Also called FO. See also forward air controller; spotter. (JP 3-09)

**gun-target line**

(DOD) An imaginary straight line from gun to target. Also called GTL. (JP 3-09.3)

**joint fires observer**

(DOD) A trained Service member who can request, adjust, and control surface-to-surface fires, provide targeting information in support of Type 2 and 3 close air support terminal attack control, and perform autonomous terminal guidance operations. Also called JFO. (JP 3-09.3)

**mensuration**

(DOD) The process of measurement of a feature or location on the earth to determine an absolute latitude, longitude, and elevation. (JP 3-60)

**observation post**

(Army) A position from which military observations are made, or fire directed and adjusted, and which possesses appropriate communications. While aerial observers and sensors systems are extremely useful, those systems do not constitute aerial observation posts (FM 3-90-2).

**on-call target**

(DOD) Planned target upon which fires or other actions are determined using deliberate targeting and triggered, when detected or located, using dynamic targeting. See also dynamic targeting; on-call; operational area; planned target; target. (JP 3-60)

**planned target**

(DOD) Target that is known to exist in the operational environment, upon which actions are planned using deliberate Targeting, creating effects which support commander's objectives. There are two subcategories of planned Targets: scheduled and on-call. See also on-call Target; operational area; scheduled Target; Target. (JP 3-60)

**priority target**

(Army) A target, based on either time or importance, on which the delivery of fires takes precedence over all the fires for the designated firing unit or element. (FM 3-09)

**\*program of targets**

(Army) A number of planned targets of a similar nature that are planned for sequential attack. (FM 3-09)

**scheduled target**

(DOD) Planned target upon which fires or other actions are scheduled for prosecution at a specified time. See also planned target; target. (JP 3-60)

**\*spotting**

(DOD) Parking aircraft in an approved shipboard landing site. (JP 3-04)

### **target**

(DOD) 1. An entity or object that performs a function for the adversary considered for possible engagement or other action. 2. In intelligence usage, a country, area, installation, agency, or person against which intelligence operations are directed. 3. An area designated and numbered for future firing. 4. In gunfire support usage, an impact burst that hits the target. See also objective area. (JP 3-60)

### **target of opportunity**

(DOD) 1. A target identified too late, or not selected for action in time, to be included in deliberate targeting that, when detected or located, meets criteria specific to achieving objectives and is processed using dynamic targeting. 2. A target visible to a surface or air sensor or observer, which is within range of available weapons and against which fire has not been scheduled or requested. (JP 3-60)

### **target reference point**

(DOD) A predetermined point of reference, normally a permanent structure or terrain feature that can be used when describing a target location. Also called TRP. (JP 3-09.3)

### **techniques**

(DOD) Non-prescriptive ways or methods used to perform missions, functions, or tasks. See also procedures; tactics. (CJCSM 5120.01A)

### **terminal guidance operations**

(DOD) Actions using electronic, mechanical, voice, or visual communications that provide approaching aircraft and/or weapons additional information regarding a specific target location. Also called TGO. (JP 3-09)

# References

## REQUIRED PUBLICATIONS

ADRP 1-02, Terms and Military Symbols, 16 November 2016.  
DOD Dictionary of Military and Associated Terms. August 2017.

## RELATED PUBLICATIONS

### JOINT AND DEPARTMENT OF DEFENSE PUBLICATIONS

Most joint publications are available online:

[HTTP://WWW.DTIC.MIL/DOCTRINE/INDEX.HTM](http://www.dtic.mil/doctrine/index.htm)

Most Chairman of the Joint Chiefs of Staff publications are available online:

[HTTP://WWW.DTIC.MIL/DOCTRINE/DOCTRINE/CJCS.HTM](http://www.dtic.mil/doctrine/doctrine/cjcs.htm)

Most Department of Defense Directives are available online at:

[HTTP://WWW.DTIC.MIL/WHs/DIRECTIVES/](http://www.dtic.mil/whs/directives/)

Most Department of Defense Publications are available online at:

[HTTPS://WWW.DEFENSE.GOV/PORTALS/1/DOCUMENTS/PUBS/DOD%20LAW%20OF%20WAR%20MANUAL%20%20JUNE%202015%20UPDATED%20DEC%202016.PDF?VER=2016-12-12-172036190](https://www.defense.gov/portals/1/documents/pubs/dod%20law%20of%20war%20manual%20%20june%202015%20updated%20dec%202016.pdf?VER=2016-12-12-172036190)

Chairman of the Joint Chiefs of Staff Instruction (CJCSI) 3505.01C. *Target Coordinate Mensuration Certification and Program Accreditation* 28 October 2016.

Chairman of the Joint Chiefs of Staff Manual (CJCSM) 5120.01A. *Joint Doctrine Development Process*. 29 December 2014.

Department of Defense Law of War Manual, June 2015.

Joint Fires Observer Memorandum of Agreement, 28 July 2016.

[HTTPS://WWW.US.ARMY.MIL/SUITE/DOC/47382398](https://www.us.army.mil/suite/doc/47382398)

JP 3-0 *Joint Operations*, 17 January 2017.

JP 3-04 *Joint Shipboard Helicopter and Tiltrotor Aircraft Operations*, 06 December 2012.

JP 3-09 *Joint Fire Support*. 12 December 2014.

JP 3-09.3 *Close Air Support*, 25 November 2014.

JP 3-60 *Joint Targeting*, 31 January 2013.

### NORTH ATLANTIC TREATY ORGANIZATION STANDARDIZATION AGREEMENTS

Most North Atlantic Treaty Organization standardization agreement agency publications are available online: <http://nso.nato.int/nso/>.

STANAG 2934, *AArtyP-1(B), Artillery Procedures*, 5 November 2015.

### ARMY PUBLICATIONS

Most Army doctrinal publications are available online: [www.apd.army.mil](http://www.apd.army.mil).

ADP 1 *The Army*, September 17, 2012.

ADP 3-0 *Operations*, 11 November 2016.

ADP 3-09 *Fires*, 31 August 2012.

## References

---

- ADRP 1 The Army Profession, 14 June 2015.
- ADRP 3-0 Operations, 11 November 2016.
- ADRP 3-09 Fires, 31 August 2012.
- ADRP 3-37 Protection, 31 August 2012.
- ARDP 6-0 Mission Command, 17 May 2012.
- ATP 3-04.1 Aviation Tactical Employment, 13 April 2016
- ATP 3-09.32; MCRP 3-16.6A; NTTP 3-09.2; AFTTP 3-2.6 JFIRE Multi-Service Procedures for the Joint Application of Firepower, 21 January 2016.
- ATP 3-09.42 Fire Support for the Brigade Combat Team, 1 March 2016.
- ATP 3-09.50 The Field Artillery Cannon Battery, 4 May 2016.
- ATP 3-34.22 Engineer *Operations-Brigade Combat Team and Below*, 05 December 2014.
- ATP 3-60 *Targeting*, 7 May 2015.
- ATP 5-19 *Risk Management*, 14 April 2014.
- FM 3-09 *Field Artillery Operations and Fire Support*, 04 April 2014.
- FM 3-90-2 *Reconnaissance, Security, and Tactical Enabling Tasks Volume 2*, 22 March 2013.
- FM 27-10 *The Law of Land Warfare* 18 July 1956.
- GTA 06-07-005 *Observed Fire Reference Card*, April 2016.
- GTA 17-02-015 *Call For Fire*, November 2009.
- MIL-STD-2525D *Department of Defense Interface Standard: Joint Military Symbolology*, 10 June 2014.  
[http://www.dtic.mil/doctrine/doctrine/other/ms\\_2525d.pdf](http://www.dtic.mil/doctrine/doctrine/other/ms_2525d.pdf)
- TB 9-1320-203-10 *Operator Information for Projectile, 155mm: Infrared (IR), Illuminating, XM1066* (this item is included on EM0162), 21 May 2009.
- TM 43-0001-28, *Army Ammunition Data Sheets Artillery Ammunition for Guns, Howitzers, Mortars, Recoilless Rifles, and 40mm Grenade Launchers (Federal Supply Class 1310, 1315, 1320, 1390)*, 26 August 2016.

### TRAINING CIRCULARS

- TC 3-09.8 *Field Artillery Gunnery*, 15 November 2013.
- TC 3-09.81 *Field Artillery Manual Cannon Gunnery*, 13 April 2016.
- TC 3-22.91 *Mortar Fire Direction Procedures*, 15 May 2017.
- TC 3-25.26 *Map Reading and Land Navigation*, 15 November 2013.

### ARMY REGULATIONS

- AR 385-63; MCO 3570.1C *Range Safety*, 30 January 2012.

### WEB SITES

- Army Publishing Directorate: [www.apd.army.mil](http://www.apd.army.mil).
- Joint Electronic Library Chairman of the Joint Chiefs of Staff Library:  
[www.dtic.mil/doctrine/index.htm](http://www.dtic.mil/doctrine/index.htm)
- Joint Electronic Library: [www.dtic.mil/doctrine/new\\_pubs/jointpubs.htm](http://www.dtic.mil/doctrine/new_pubs/jointpubs.htm).
- North Atlantic Treaty Standardization Agreement agency publications: <http://nsa.nato.int/nsa/>.
- Marine Corps Publications: <https://www.dctrine.usmc.mil/currentPubsListing.asp>.

### PRESCRIBED FORMS

- Unless otherwise indicated, DA Forms are available on the Army Publishing Directorate (APD) web site: [www.apd.army.mil](http://www.apd.army.mil).

DA Form 2185. Artillery Counterfire Information.

DA Form 4655. Target List Worksheet.

DA Form 5429. Conduct of Fire.

## **RELATED FORMS**

Unless otherwise indicated, DA Forms are available on the Army Publishing Directorate (APD) web site: [www.apd.army.mil](http://www.apd.army.mil).

DD Forms are available on the Office of the Secretary of Defense (OSD) web site:

[http://www.esd.whs.mil/Directives/forms/dd1500\\_1999/](http://www.esd.whs.mil/Directives/forms/dd1500_1999/)

DA Form 2028. Recommended Changes to Publications and Blank Forms.

DD Form 1972 *Joint Tactical Air Strike Request*.

This page intentionally left blank.



# Index

Index entries are by paragraph number.

**A**  
adjustment techniques, 5-9  
altitude, 3-12  
angle T, 3-5  
azimuth, 3-3

**C**  
call for fire, 4-1  
    method of engagement, 4-5  
    method of fire and control, 4-7  
    observer identification, 4-2  
    target description, 4-4  
    target location, 4-3  
    warning order, 4-2  
cardinal directions, 3-4  
combat identification, 3-22  
correction of errors, 4-9

**D**  
deviation correction, 5-5  
direction, 3-3

**E**  
estimate distance, 3-8

**F**  
final protective fire, 1-7, 7-4  
fire for effect, 5-11  
fire support officer, 2-3  
fire support sergeant, 2-3  
fire support specialist, 2-4  
flash to bang, 3-8  
forward observer, 2-4

**G**  
group of targets, 1-11

**I**  
irregularly shaped target, 7-8

**J**  
joint fires observer, 2-5

**M**  
mensuration, 3-2  
message to observer, 4-9  
moving target, 5-31

**O**  
observation post, 2-8  
observed fire (OF) fan, 3-10  
on-call target, 1-7

**P**  
planned target, 1-7  
priority target, 1-7  
program of targets, 1-12

**R**  
registration, 5-13  
    abbreviated, 5-25  
    high-burst, 5-27  
    mean point of impact, 5-30  
    mortar, 5-18  
    precision, 5-14  
    second lot, 5-25  
    time, 5-21

**S**  
scheduled target, 1-7  
SLOCTOP, 2-9  
special munitions, 6-1  
    precision guided mortar  
    munition, 6-3  
    excalibur, 6-1  
    guided multiple launch  
    rocket system, 6-5  
    illumination, 6-13  
    improved conventional  
    munitions, 6-5  
    precision guidance kit, 6-4  
    scatterable mines, 6-9  
    smoke, 6-20  
subsequent corrections, 5-6

**T**  
target, 1-6  
    circular, 1-10  
    linear, 1-9  
    point, 1-9  
    rectangular, 1-10  
target location methods, 3-15  
    grid coordinates, 3-15  
    laser grid, 3-16  
    laser polar, 3-16  
    polar plot, 3-16  
    shift from known point, 3-17  
target numbering, 1-12  
target of opportunity, 1-6  
target reference point, 1-11  
terrain sketch, 3-14

**V**  
vertical angle, 3-13  
vertical shift, 3-13

This page intentionally left blank.

**ATP 3-09.30**  
**28 September 2017**

By Order of the Secretary of the Army:

**MARK A. MILLEY**  
*General, United States Army*  
*Chief of Staff*

Official:

A handwritten signature in black ink, appearing to read "Gerald B. O'Keefe". The signature is written in a cursive style with a large initial "G" and "O".

**GERALD B. O'KEEFE**  
*Administrative Assistant to the*  
*Secretary of the Army*  
1723510

**DISTRIBUTION:**

*Active Army, Army National Guard, and United States Army Reserve:* Distributed in electronic media only (EMO).

